

User's Guide

Agilent Technologies 8712ES and 8714ES RF Network Analyzers



Agilent Technologies

Part No. 08714-90012

Printed in USA

Print Date: June 2000

Supersedes: October 1999

© Copyright 1998–2000 Agilent Technologies, Inc.

Notice

The information contained in this document is subject to change without notice. Agilent Technologies makes no warranty of any kind with regard to this material, including but not limited to, the implied warranties of merchantability and fitness for a particular purpose. Agilent Technologies shall not be liable for errors contained herein or for incidental or consequential damages in connection with the furnishing, performance, or use of this material.

Key Conventions

This manual uses the following conventions:

FRONT PANEL KEY

This represents a key physically located on the instrument (a “hardkey”).

Softkey

This indicates a “softkey,” a key whose label is determined by the instrument’s firmware, and is displayed on the right side of the instrument’s screen next to the eight unlabeled keys.

Screen Text

This indicates text displayed on the instrument’s screen.

Safety Information

For safety and regulatory information see [Chapter 10, “Safety and Regulatory Information.”](#) For warranty and assistance information see [Chapter 9, “Specifications.”](#)

Firmware Revision

This manual documents analyzers with firmware revisions E.06.00 and above.

Acknowledgments

Lotus® 1-2-3® are U.S. registered trademarks of Lotus Development Corporation.

Windows®, Word97®, and Excel97® are registered trademarks of Microsoft Corp.

Portions of the software include source code from the Info-ZIP group. This code is freely available on the Internet by anonymous ftp [asftp.uu.net:/pub/archiving/zip/unzip51/.tar.Z](ftp://asftp.uu.net/pub/archiving/zip/unzip51/.tar.Z), and from CompuServe [asunz51.zip](ftp://asunz51.zip) in the IBMPRO forum, library 10, (data compression).

Introducing the Analyzer

The 8712ES and 8714ES are easy-to-use RF network analyzers optimized for production measurements of S-parameters. The instrument integrates an RF synthesized source, S-parameter test set, multi-mode receivers, and display in one compact box.

The source features 1 Hz resolution, 40 ms (or faster) sweep time, and up to +13 dBm output power.

S-parameter test sets provide the capability to measure reflection and transmission characteristics of two-port devices in either the forward or reverse direction with a single connection. RF power can come out of either the analyzer's port 1 or port 2, and either port can be connected to a receiver. S-parameter test sets also allow full two-port (12 term) error correction, which is the most accurate form available.

The three-channel, dual mode receivers provide dynamic range of greater than 100 dB in narrowband-detection measurement mode. For measurements of frequency-translating devices, the network analyzer features broadband internal detectors and external detector inputs. The receivers incorporate digital signal processing and microprocessor control to speed operation and measurement throughput.

Two independent measurement channels and a large display show the measured results of one or two receiver channels in several user-selectable formats. An external VGA monitor can be connected to the rear panel for enhanced measurement viewing in color.

Measurement functions are selected with front panel hardkey and softkey menus. Measurements can be printed or plotted directly with a compatible peripheral. Instrument states can be saved to the internal floppy disk, internal non-volatile memory, or internal volatile memory. Built-in service diagnostics are available to simplify troubleshooting procedures.

Measurement calibrations and data averaging provide performance improvement and flexibility. Measurement calibrations consist of normalizing data, utilizing the internal factory calibration, or calibrating with external standards. Measurement calibration reduces errors

associated with crosstalk, directivity, source and load match, and frequency response. Refer to [Chapter 9, “Specifications,”](#) for error correction specifications.

How to Use This Guide

The first 6 chapters of this guide explain how to perform measurements, calibrate the instrument, and use the most common instrument functions.

Chapters 7 through 11 are reference material. Use these chapters to look up information such as front panel features, specific key functions, and specifications.

8712ES and 8714ES Network Analyzer Documentation Map



The **CDROM** provides the contents of all of the documents listed below.

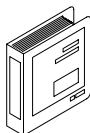

The **User's Guide** shows how to make measurements, explains commonly-used features, and tells you how to get the most performance from the analyzer.

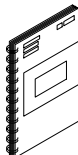

The **LAN Interface User's Guide Supplement** shows how to use a local area network (LAN) for programming and remote operation of the analyzer.

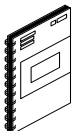

The **Automating Measurements User's Guide Supplement** provides information on how to configure and control test systems for automation of test processes.

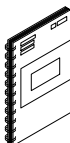

The **Programmer's Guide** provides programming information including GPIB and SCPI command references, as well as short programming examples.

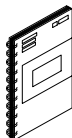

The **Example Programs Guide** provides a tutorial introduction using BASIC programming examples to demonstrate the remote operation of the analyzer.

The **Service Guide** provides the information needed to adjust, troubleshoot, repair, and verify analyzer conformance to published specifications.

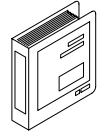

The **HP Instrument BASIC User's Handbook** describes programming and interfacing techniques using HP Instrument BASIC, and includes a language reference.

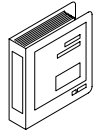

The **HP Instrument BASIC User's Handbook Supplement** shows how to use HP Instrument BASIC to program the analyzer.

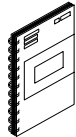

The **Option 100 Fault Location and Structural Return Loss Measurements User's Guide Supplement** provides theory and measurement examples for making fault location and SRL measurements. (Shipped only with Option 100 analyzers.)

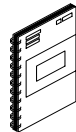

The **CATV Quick Start Guide** provides abbreviated instructions for testing the quality of coaxial cables. (Shipped only with Option 100 analyzers.)



The **Cellular Antenna Quick Start Guide** provides abbreviated instructions for verifying the performance of cellular antenna systems. (Shipped only with Option 100 analyzers.)

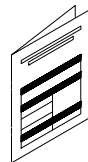

Contents

1. Installing the Analyzer

Introduction	1-2
Step 1. Check the Shipment	1-3
Step 2. Meet Electrical and Environmental Requirements.	1-4
Step 3. Check the Analyzer Operation	1-9
Step 4. Configure the Analyzer	1-10
Connecting Peripherals and Controllers.	1-11
Installing the Analyzer in a Rack	1-16
Preventive Maintenance	1-17
Clean the CRT	1-17
Check the RF Front Panel Connectors	1-17

2. Getting Started

Introduction	2-2
Front Panel Tour	2-3
Entering Measurement Parameters	2-4
Presetting the Analyzer	2-5
Entering Frequency Range	2-6
Entering Source Power Level.	2-6
Scaling the Measurement Trace	2-6
Entering the Active Measurement Channel and Type of Measurement.	2-7
Viewing Measurement Channels.	2-8
Performing the Operator's Check	2-10
Equipment List.	2-10
Make S21 and S12 Transmission Measurements.	2-11
Make a Broadband Power Measurement	2-13
Make S11 and S22 Reflection Measurements.	2-14
If the Analyzer Fails the Operator's Check.	2-17

3. Making Measurements

Introduction	3-2
Measuring Devices with Your Network Analyzer	3-3
The Measurement Display Icon.	3-7
Measuring S-Parameters	3-9
Attenuation and Amplification in a Measurement Setup	3-11
When to Change the System Impedance.	3-12

Contents

The Typical Measurement Sequence	3-13
Using the BEGIN Key to Make Measurements	3-14
BEGIN Key Overview	3-15
Using the BEGIN Key to Configure Measurements	3-16
AUTOST files	3-18
The User BEGIN Function	3-18
Measuring S-Parameters using a Two-Port Calibration	3-19
Enter the Measurement Parameters	3-20
Perform a User Two-Port Calibration	3-20
View and Interpret the S-Parameter Measurement Results	3-40
Measuring S21 Forward Transmission using an Enhanced Response Calibration	3-41
Enter the Measurement Parameters	3-42
Perform an Enhanced Response Calibration	3-42
Connect the DUT	3-45
View and Interpret the S21 Measurement Results	3-46
Measuring S11 Reflection Port 1 using a One-Port Calibration	3-48
Enter the Measurement Parameters	3-49
Perform a User One-Port Calibration	3-49
Connect the DUT	3-52
View and Interpret the S11 Measurement Results	3-54
Making a Power Measurement using Broadband Detection	3-56
Enter the Measurement Parameters	3-56
Perform a Normalization Calibration	3-57
Connect the DUT	3-58
View and Interpret the Power Measurement Results	3-59
Measuring Conversion Loss	3-61
Enter the Measurement Parameters	3-62
Perform a Normalization Calibration	3-62
Connect the DUT	3-64
View and Interpret the Conversion Loss Results	3-65
Making Measurements with the Auxiliary Input	3-67
Auxiliary Input Characteristics	3-68
Measuring Group Delay	3-69
Enter the Measurement Parameters	3-70
Perform a User Two-Port Calibration	3-71
Connect the DUT	3-71
View and Interpret the Group Delay Measurement Results	3-71

Contents

Measuring Impedance using the Smith Chart.	3-73
Enter the Measurement Parameters.	3-74
Perform a User Two-Port Calibration	3-74
Connect the DUT	3-75
View and Interpret the Impedance Measurement Results	3-76
Measuring Impedance Magnitude	3-80
How the Reflection Measurement Works	3-80
How the Transmission Measurement Works	3-81

4. Using Instrument Functions

Introduction	4-2
Using Markers	4-3
To Activate Markers.	4-5
To Turn Markers Off	4-6
To Use Marker Search Functions	4-7
To Use Marker Math Functions.	4-18
To Use Delta (Δ) Marker Mode	4-24
To Use Other Marker Functions	4-26
To Use Polar Format Markers	4-27
To Use Smith Chart Markers.	4-27
Using Limit Testing.	4-28
To Create a Flat Limit Line	4-29
To Create a Sloping Limit Line	4-30
To Create a Single Point Limit	4-32
To Use Marker Limit Functions	4-32
To Use Relative Limits.	4-36
Other Limit Line Functions.	4-37
Additional Notes on Limit Testing	4-39
Using Reference Tracking.	4-42
To Track the Peak Point.	4-43
To Track a Frequency.	4-44
Customizing the Display	4-45
Using the Split Display Feature	4-46
Enabling/Disabling Display Features	4-47
Modifying Display Annotation.	4-48
Expanding the Displayed Measurement.	4-52

Contents

Using Memory Traces	4-55
To Store a Data Trace to the Display Memory	4-55
To View the Measurement Data and Memory Trace	4-55
To Divide Measurement Data by the Memory Trace	4-56
Saving and Recalling Measurement Results	4-57
Saving Instrument Data	4-59
To Recall from a Floppy Disk or Internal Memory	4-62
Other File Utilities	4-65
To Use Directory Utilities	4-67
Formatting a Floppy Disk	4-69
Connecting and Configuring Printers and Plotters	4-70
Select a Compatible Plotter or Printer	4-70
Select an Appropriate Interface Cable	4-71
Connect the Printer or Plotter	4-72
Configure the Hardcopy Port	4-73
Define the Printer or Plotter Settings	4-75
Printing and Plotting Measurement Results	4-80
To Select the Copy Port	4-80
To Define the Output	4-81
Using a Keyboard	4-85
To Connect the Keyboard	4-85
To Use the Keyboard to Edit	4-86
Front Panel Control using a Keyboard	4-86
Using an External VGA Monitor	4-89
Customizing Color on an External Monitor	4-89
Synchronizing and Positioning the Display	4-91

5. Optimizing Measurements

Introduction	5-2
Increasing Sweep Speed	5-3
Select the Appropriate Calibration Type	5-3
To Increase the Start Frequency	5-4
To Set the Sweep Time to AUTO Mode	5-4
To Widen the System Bandwidth	5-4
To Reduce the Amount of Averaging	5-5
To Reduce the Number of Measurement Points	5-5

Contents

To View a Single Measurement Channel	5-6
To Turn Off Alternate Sweep.	5-7
To Turn Off Markers and Marker Tracking	5-7
To Turn Off Spur Avoidance	5-8
To Avoid Frequency Bandcrossings by Minimizing the Span (8714ES only)	5-8
Increasing Network Analyzer Dynamic Range	5-9
To Increase the Receiver Input Power.	5-9
To Reduce the Receiver Noise Floor	5-10
Reducing Trace Noise	5-12
To Activate Averaging for Reducing Trace Noise	5-12
To Change System Bandwidth for Reducing Trace Noise	5-12
To Eliminate Receiver Spurious Responses	5-13
Reducing Mismatch Errors	5-15
Reducing Mismatch Errors in a Reflection Measurement	5-15
Reducing Mismatch Errors in a Transmission Measurement	5-16
Reducing Mismatch Errors when Measuring Both Reflection and Transmission	5-17
Compensating for Phase Shift in Measurement Setups	5-18
Port Extensions.	5-18
Electrical Delay	5-20
Measuring Devices with Long Electrical Delay	5-21

6. Calibrating for Increased Measurement Accuracy

Introduction	6-2
Measurement Calibration Overview.	6-3
The Calibration Reference Plane.	6-7
Default versus User-Defined Calibration.	6-8
When to Use a Default Calibration	6-8
When to Perform a User-Defined Calibration.	6-8
Calibration Choices	6-9
Retrieving Previous User-Defined Calibrations	6-12
Presetting the Analyzer: How Calibration Is Affected.	6-13
To Perform a Normalization Calibration.	6-14
To Perform a Transmission Calibration	6-15
To Perform a Reflection Calibration	6-19
To Perform a Conversion Loss Calibration	6-22

Contents

Calibration Kits	6-23
Selecting a Calibration Kit Stored in the Analyzer	6-23
Creating a User-Defined Calibration Kit	6-25
Saving and Recalling the Calibration	6-33
Saving the Calibration	6-33
Recalling the Calibration	6-34

7. Front/Rear Panel

Introduction	7-2
Connectors	7-3
BNC Connectors	7-4
Multi-pin Connectors	7-7
RF Connectors	7-15
Display	7-16
Knob	7-18
Power Switch	7-19
Display Intensity Control	7-20
Disk Drive	7-21
Line Module	7-22
Power Cables	7-22
The Line Fuse	7-24
The Voltage Selector Switch	7-25

8. Hardkey/Softkey Reference

Introduction	8-2
Numeric Entries	8-3
A	8-6
B	8-12
C	8-15
D	8-21
E	8-28
F	8-31
G	8-36
H	8-39
I	8-42
K	8-45

Contents

L	8-46
M	8-52
N	8-60
O	8-63
P	8-64
R	8-69
S	8-75
T	8-89
U	8-94
V	8-97
W	8-99
X	8-100
Y	8-101
Z	8-103

9. Specifications

Definitions	9-2
System Performance	9-3
Test Port Output	9-23
Test Port Input	9-29
General Information	9-39
Features	9-45
Measurement	9-45
Storage	9-47
Data Hardcopy	9-47
Automation	9-48
Measurement Calibration	9-50
Options	9-53
Warranty	9-55
Limitation of Warranty	9-56
Exclusive Remedies	9-56
Agilent Technologies Sales and Service Offices	9-57

Contents

10. Safety and Regulatory Information

Safety and Regulatory Information	10-2
Safety Information	10-3
Warnings	10-3
Cautions	10-4
Statement of Compliance	10-4
Cleaning Instructions	10-4
Shipping Instructions	10-4
Instrument Markings	10-5
Regulatory Information	10-6
Notice for Germany: Noise Declaration	10-6
Declaration of Conformity	10-6

11. Factory Preset State and Memory Allocation

Factory Preset and Peripheral States	11-2
Factory Preset State	11-2
Peripheral State	11-8
Volatile Settings	11-12
Save/Recall Memory Allocation	11-13
Types of Storage Disks	11-13
Types of Storable Information	11-15
How to Determine the Size of Disk Files	11-16
Memory Usage Notes	11-18

1 **Installing the Analyzer**

Introduction

This chapter will guide you through the four steps needed to correctly and safely install your network analyzer. The four steps are:

1. Check the Shipment
2. Meet Electrical and Environmental Requirements
3. Check the Analyzer Operation
4. Configure the Analyzer

Step 1. Check the Shipment

After you have unpacked your instrument, it is recommended that you keep the packaging materials so they may be used if your instrument should need to be returned for maintenance or repair.

NOTE

The packaging material is designed to protect the analyzer from damage that can happen during shipping. Returning the analyzer in anything other than the original packaging may result in non-warranted damage.

Check the items received against the Product Checklist (included in your shipment) to make sure that you received everything.

Inspect the analyzer and all accessories for any signs of damage that may have occurred during shipment. If your analyzer or any accessories appear to be damaged or missing, call your nearest Agilent Technologies sales or service office. Refer to [Table 9-10, “Agilent Technologies Sales and Service Offices,”](#) in [Chapter 9](#) for the nearest office.

Step 2. Meet Electrical and Environmental Requirements

1. Set the line voltage selector to the position that corresponds to the ac power source you will be using.

CAUTION

Before switching on this instrument, make sure that the line voltage selector switch is set to the voltage of the mains supply and the correct fuse (T 5 A 250 V) is installed. Assure the supply voltage is in the specified range.

NOTE

The working fuse and a spare are located in the power cable receptacle. See [Figure 7-12, "Location of Line Fuses,"](#) in [Chapter 7](#).

Figure 1-1 Voltage Selector Switch Location

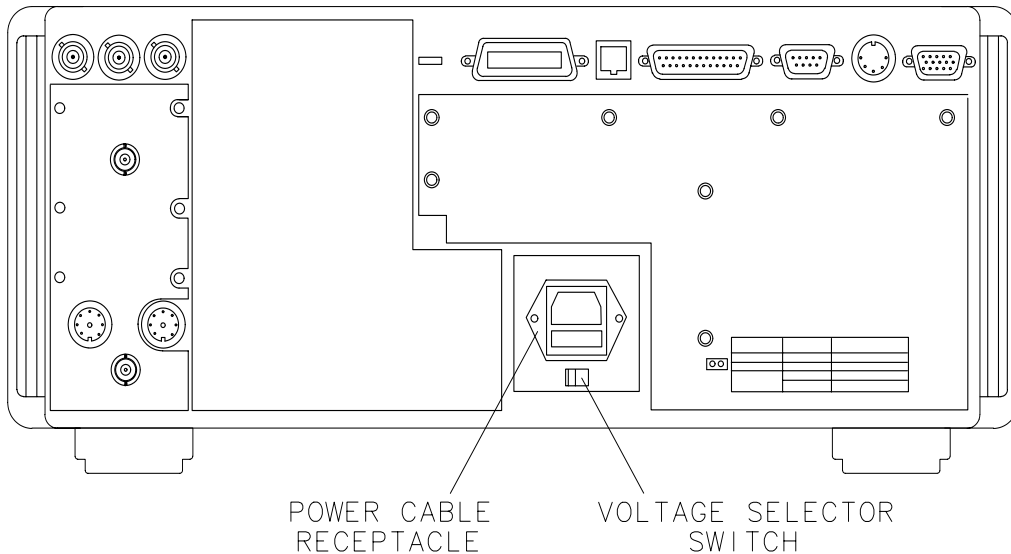

pp64c

2. Ensure the available ac power source meets the following requirements:

Nominal Setting	AC Line Power
115 V	90 to 132 Vac (47 to 63 Hz)
230 V	198 to 264 Vac (47 to 63 Hz)

If the ac line voltage does not fall within these ranges, an autotransformer that provides third-wire continuity to ground should be used.

3. Ensure the operating environment meets the following requirements for safety:
- indoor use
 - altitude up to 15,000 feet (4,572 meters)
 - temperature 0 °C to 55 °C
 - maximum relative humidity 5 to 95 percent relative at +40 °C (non-condensing)

CAUTION

This product is designed for use in Installation Category II and Pollution Degree 2 per IEC 1010 and 664 respectively.

NOTE

The above requirements are for safety only. Separate conditions that must be met for specified performance are noted in [Chapter 9](#).

4. Verify that the power cable is not damaged, and that the power source outlet provides a protective earth ground contact. Note that the following illustration depicts only one type of power source outlet. Refer to [Figure 7-11](#) in [Chapter 7](#) to see the different types of power cord plugs that can be used with your analyzer.

Figure 1-2 Protective Earth Ground

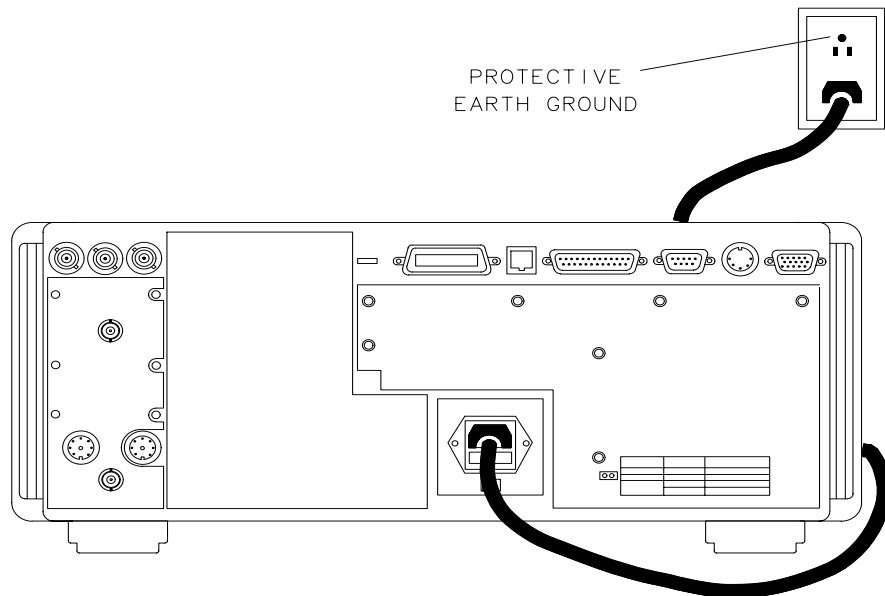

pp65c

WARNING

This is a Safety Class I product (provided with a protective earthing ground incorporated in the power cord). The mains plug shall only be inserted in a socket outlet provided with a protective earth contact. Any interruption of the protective conductor, inside or outside the instrument, is likely to make the product dangerous. Intentional interruption is prohibited.

WARNING

If this instrument is to be energized via an external autotransformer for voltage reduction, make sure that its common terminal is connected to a neutral (earthed pole) of the power supply.

5. Install the analyzer so that the detachable power cord is readily identifiable and is easily reached by the operator. The detachable power cord is the instrument disconnecting device. It disconnects the mains circuits from the mains supply before other parts of the instrument. The front panel switch is only a standby switch and not a LINE switch. Alternatively, an externally installed switch or circuit breaker (which is readily identifiable and is easily reached by the operator) may be used as a disconnecting device.
6. Install the analyzer according to the enclosure protection provided. This instrument does not protect against the ingress of water. It does protect against finger access to hazardous parts within the enclosure.
7. Ensure there are at least two inches of clearance around the sides and back of either the stand-alone analyzer or the system cabinet.

Figure 1-3 Ventilation Clearance Requirements

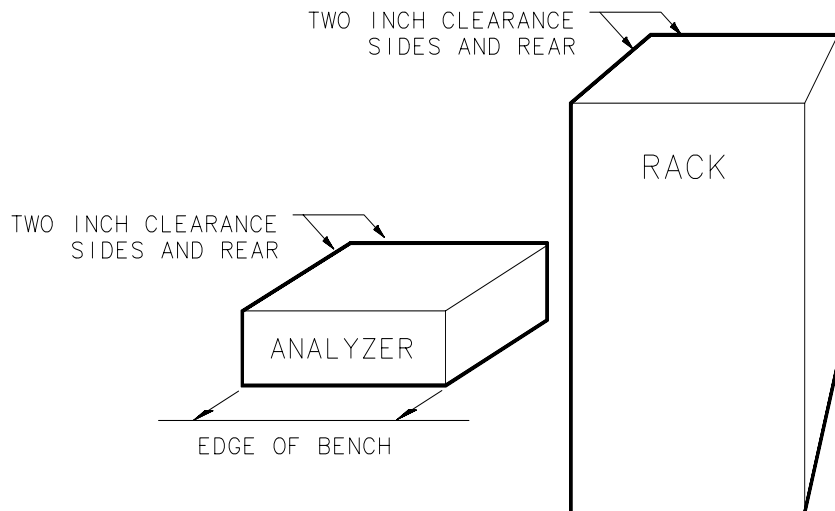

po64b

Installing the Analyzer

Step 2. Meet Electrical and Environmental Requirements

8. Set up a static-safe workstation. Electrostatic discharge (ESD) can damage or destroy components.

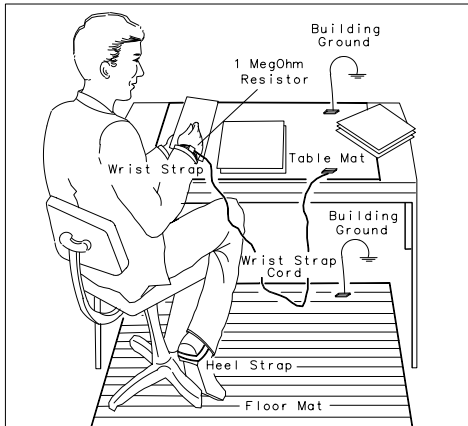

qq653d

- table mat with earth ground wire:
part number 9300-0797
- wrist-strap cord with 1 Meg Ohm resistor:
part number 9300-0980
- wrist-strap:
part number 9300-1367
- heel straps:
part number 9300-1308
- floor mat

Step 3. Check the Analyzer Operation

1. Turn on the line switch of the analyzer. After approximately 30 seconds, a display box should appear on the screen with the following information:
 - the model number of your analyzer (either 8712ES or 8714ES)
 - the firmware revision
 - the serial number of your analyzer
 - installed options
2. Verify that the serial number and options displayed on the screen match the information on the rear panel serial label.
3. The operator's check should be performed on the analyzer to provide a high degree of confidence that the analyzer is working properly. Refer to [Chapter 2, "Getting Started,"](#) for instructions on how to perform the operator's check.

Step 4. Configure the Analyzer

You can begin making measurements by simply connecting your analyzer to an appropriate power source and turning it on. This section, however, will explain how to connect common peripherals and controllers, and how to install your analyzer into a rack system.

Connecting Peripherals and Controllers

Figure 1-4 Analyzer Rear Panel Line Module and Selected Connectors

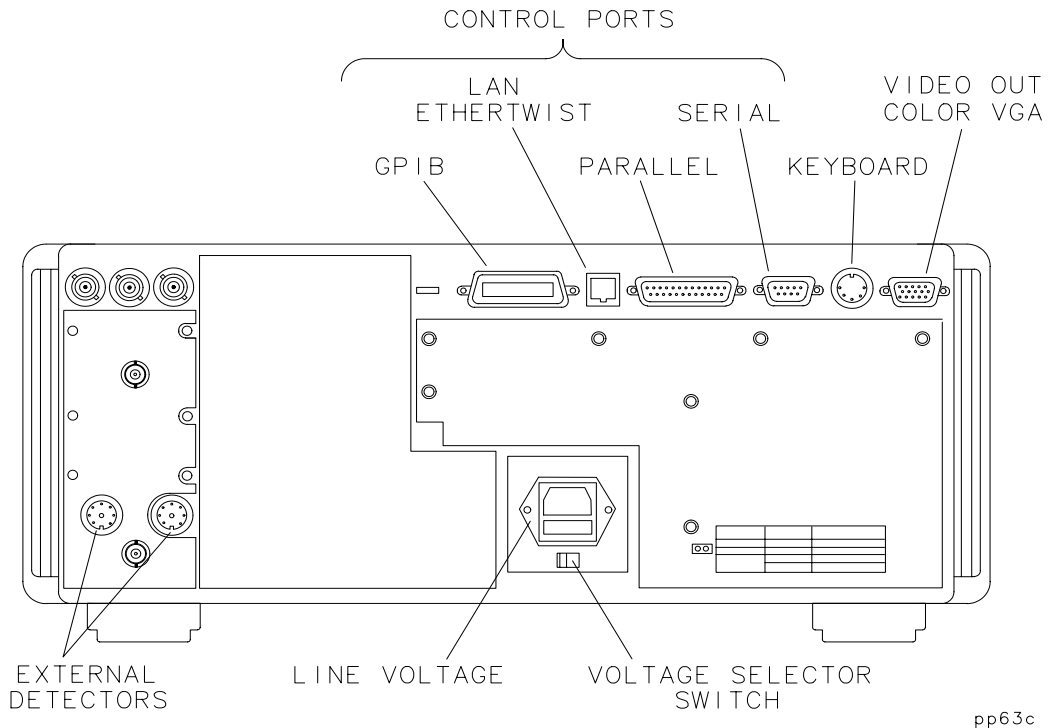

Refer to [Figure 1-4](#):

- The GPIB port is for use with computers and peripherals (printers, plotters, etc.).
- The parallel and RS-232 (serial) ports are also for peripherals. The parallel and serial ports can also be programmed via IBASIC for general I/O control. See the *HP Instrument BASIC User's Handbook* for information on using IBASIC.

Step 4. Configure the Analyzer

- The VIDEO OUT COLOR VGA port allows you to connect a color VGA monitor for enhanced viewing. See “Using an External VGA Monitor” in **Chapter 4** for more information.
- The LAN ETHERTWIST connector is for connecting your analyzer to a LAN (local area network) for control and access. See *The LAN Interface User's Guide Supplement* for information on how to use your analyzer in a LAN.

GPIB Connections A GPIB system may be connected in any configuration as long as the following rules are observed: The total number of devices is less than or equal to 15.

- The total length of all the cables used is less than or equal to 2 meters times the number of devices connected together up to an absolute maximum of 20 meters. For example, the maximum cable length is 4 meters if only 2 devices are involved. The length between adjacent devices is not critical as long as the overall restriction is met.

See **Figure 1-5** for different connection configurations.

Figure 1-5 GPIB Connection Configurations

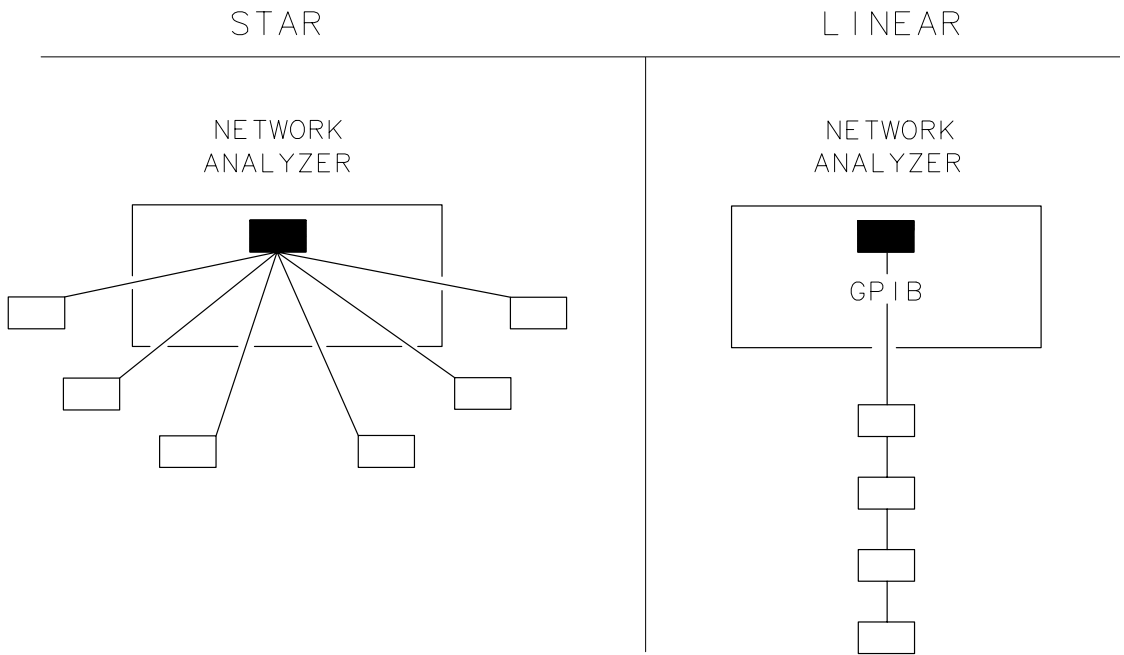

.po67b

Table 1-1 **Maximum GPIB Cable Lengths**

Instruments/Peripherals in System	Maximum GPIB Cable Length between Each Pair of Devices
Two	4 m
Fifteen (max)	20 m (total)

Parallel and Serial Connections Parallel and serial devices often require specific cables—check their manuals for details. Parallel cable length should not exceed 25 feet. The analyzer may experience problems talking to a printer if this length is exceeded. Connect the required control cables and secure them. (Tighten the knurled screws or comparable fasteners.)

Other Connections If you plan to use a keyboard, barcode reader, external video monitor, or external detectors, connect them to the appropriate rear panel connectors. See [Figure 1-4, “Analyzer Rear Panel Line Module and Selected Connectors.”](#) Also see [Chapter 7, “Front/Rear Panel,”](#) for more information on front and rear panel connectors.

To Set GPIB Addresses To communicate via GPIB, each external device must have a unique address and the network analyzer must recognize each address. To check or set each external device's actual address, refer to the device's manual (most addresses are set with switches). The following are examples of how to check or set the device's recognized address on the network analyzer:

Printer: Press **HARDCOPY** **Select Copy Port** . Use the front panel knob to highlight the line that reads HP Printer PCL HP-IB. Press **Select** . The second line of the screen displays settings: in this case the address. The default address is 5, however most printers are factory set to address 1 (one). To change the recognized address, press **Print/Plot GPIB Addr** **number** **Enter** .

Plotter: Press **HARDCOPY** **Select Copy Port** . Use the front panel knob to highlight the line that reads HP Plotter HPGL HP-IB. Press **Select** . The second line of the screen displays settings: in this case the address. The default address is 5 and most plotters are factory set to address 5, so changing the address is

probably not necessary. To change the recognized address, press **Print/Plot GPIB Addr** **Enter** .

NOTE

Only one hardcopy GPIB address can be set at a time. Changing the printer address, for example, changes the plotter to the same address.

Analyzer: Press **GPIB** , **8712ES Address** , or **8714ES Address** . The network analyzer's address will appear (the default is 16). To change the address, press **Enter** .

To Configure Peripheral Settings

If your system uses serial or parallel peripherals, follow the guidelines below to configure the system. Refer to the peripheral's manual for correct cables and settings. The parallel and serial ports have standard Centronics DB-25 and RS232 pinouts respectively as explained in [Chapter 7](#).

Serial

Devices: Press **Select Copy Port** . Use the entry controls to highlight your type of printer or plotter, and press **Select** . If the baud rate or handshake at the top of the screen are incorrect, use the softkeys to change them.

Parallel

Devices: Press **Select Copy Port** . Use the entry controls to highlight your type of printer or plotter, and press **Select** .

LAN

Printer: Press **Select Copy Port** . Use the entry controls to highlight HP LaserJet PCL5/6 PCL5 LAN, and press **Select** . If the printer IP address at the top of the screen is incorrect, press **LAN Printr IP Addr** to enter the correct IP address.

NOTE

When **Select Copy Port** is selected, the first two lines in the box at the top of the display screen show the current settings.

NOTE

Use a PCL5 printer for fastest hardcopies. See [“Configure the Hardcopy Port” on page 4-73](#) for more information.

Installing the Analyzer in a Rack

Use only the recommended rack mount kit (Option 1CM when ordered with the analyzer or part number 08712-60036 when ordered separately) with this instrument; it needs side support rails. Do not attempt to mount it by the front panel (handles) only. This rack mount kit allows you to mount the analyzer with or without handles.

To install the network analyzer in an 85043D rack, follow the instructions in the rack manual.

CAUTION

To install the network analyzer in other racks, note that they may promote shock hazards, overheating, dust contamination, and inferior system performance. Consult your Agilent customer engineer about installation, warranty, and support details.

CAUTION

VENTILATION REQUIREMENTS: When installing the product in a cabinet, the convection into and out of the instrument must not be restricted. The ambient temperature (outside the cabinet) must be less than the maximum operating temperature of the instrument by 4° C for every 100 watts dissipated in the cabinet. If the total power dissipated in the cabinet is greater than 800 watts, then forced convection must be used.

Place other system instruments (computer, printer, plotter) where convenient, within the GPIB cable length limits (see [Table 1-1](#)) or other interface cabling limits.

Preventive Maintenance

Preventive maintenance consists of two tasks. It should be performed at least every six months—more often if the instrument is used daily on a production line or in a harsh environment.

Clean the Display

Use a soft cloth and, if necessary, a mild cleaning solution to clean the display.

Check the RF Front Panel Connectors

Visually inspect the front panel connectors. The most important connectors are those to which the DUT is connected, typically the RF cable end or the PORT 1 and PORT 2 connectors. All connectors should be clean and the center pins centered. The fingers of female connectors should be unbroken and uniform in appearance. If you are unsure whether the connectors are good, gauge the PORT 1 and PORT 2 connectors to confirm that their dimensions are correct.

Figure 1-6

Maximum and Minimum Protrusion of Center Conductor from Mating Plane

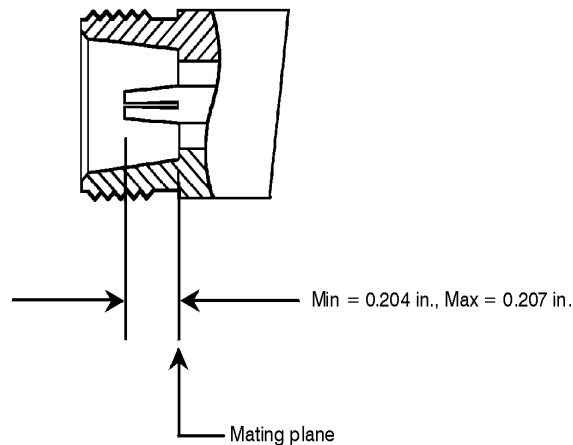

po644 b_c

2**Getting Started**

Introduction

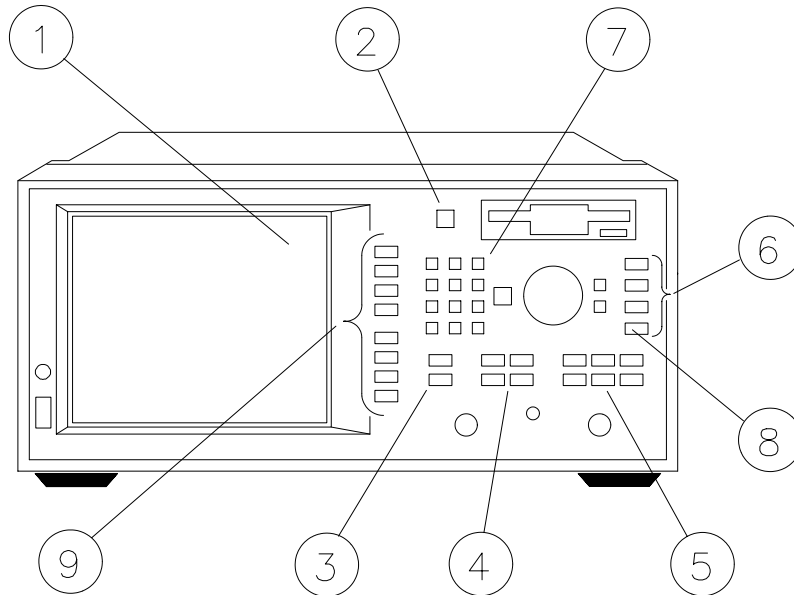

The 8712ES and 8714ES are easy-to-use, fully integrated RF component test systems. Each instrument includes a synthesized source, a wide dynamic range receiver, and a built-in test set. Controls are grouped by functional block, and settings are displayed on the instrument screen. This section familiarizes new users with the layout of the front panel and the process of entering measurement parameters into the analyzer.

Figure 2-1 Network Analyzer Front Panel Features



po648b



Front Panel Tour

1 The CRT Display	The analyzer's large CRT displays data, markers, limit lines, Instrument BASIC (IBASIC) programming code, softkey menus and measurement parameters quickly and clearly. Refer to "Display" on page 7-16 in for more information.
2 BEGIN	The BEGIN key simplifies measurement setups. The BEGIN key allows quick and easy selection of basic measurement parameters for a user-specified class of devices (e.g., filters, amplifiers, or mixers). For example, when making an S_{21} forward transmission measurement or an S_{12} reverse transmission measurement, selecting Filter as your device type puts the analyzer into narrowband detection mode, maximizing measurement dynamic range. In comparison, selecting Mixer as your device type puts the analyzer into broadband detection mode, enabling frequency translation measurements. This capability allows new users to start making measurements with as few as four keystrokes.
3 MEAS	The measure keys select the measurements for each measurement channel. The analyzer's measurement capabilities include S_{11} (reflection port 1), S_{21} (forward transmission), S_{12} (reverse transmission), S_{22} (reflection port 2), power, conversion loss, and multipoint selection (for use with multipoint test sets).
4 SOURCE	The source keys select the desired source output signal to the device under test, for example, selecting source frequency range or output power. The source keys also control sweep time, number of points, and sweep triggering.
5 CONFIGURE	The configure keys control receiver and display parameters. These parameters include receiver bandwidth and averaging, display scaling and format, marker functions, and instrument calibration.
6 SYSTEM	The system keys control system level functions. These include instrument preset, save/recall, and hardcopy output. GPIB parameters and IBASIC are also controlled with these system keys.
7 The Numeric Keypad	Use the number keys to enter a specific numeric value for a chosen parameter. Use the ENTER key or the softkeys to terminate the numeric entry with the appropriate units. You can also use the front panel knob for making continuous adjustments to parameter values, while the   keys allow you to change values in steps.
8 HARDKEYS	Hardkeys are front panel keys physically located on the instrument front panel. In text, these keys will be represented by the key name with a box around it such as: PRESET .
9 Softkeys	Softkeys are keys whose labels are determined by the analyzer's firmware. The labels are on the screen next to the 8 blank keys, which are located along the right edge of the analyzer's display. In text, these softkeys will be represented by the key name with shading behind it such as: Sweep Time .







Entering Measurement Parameters

This section describes how to input measurement parameter information into the network analyzer.

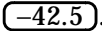
NOTE

When entering parameters, you can use the numeric keypad, as described in each example, or you can use the   keys or the front panel knob to enter data.

NOTE

When you are instructed to enter numeric values in this manual, it often can get cluttered and confusing to depict each key stroke. So in this manual, numbers (no matter how many characters) are depicted inside one keycap. For example, if you are instructed to enter the number **-42.5**, it will be depicted inside one keycap like this: . To enter this number, the following keys need to be pressed in succession:     .

You can follow along with these examples by connecting the filter and cable that were supplied with your instrument as shown in [Figure 2-2](#).

Figure 2-2

Connect the Filter to the Analyzer

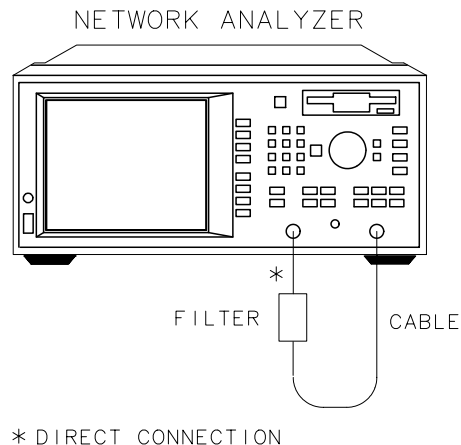

pp61es

Presetting the Analyzer

Press the **PRESET** key and then press either **User Preset** or **Factory Preset**. The **User Preset** key returns the analyzer to user-defined preset settings you may have saved as file UPRESET.STA. If this file doesn't exist, you can create it by following the instructions in the pop-up message that appears when the key is pressed. When the **Factory Preset** key is pressed, the following major default conditions apply:

Frequency range (8712 ES)	0.3 to 1300 MHz
Frequency range (8714 ES)	0.3 to 3000 MHz
Power level ¹	0 dBm
Measurement Channel 1 measurement	S ₂₁ Forward Transmission
Measurement Channel 2 measurement	Off
Format	Log Magnitude
Number of points	201
Sweep time	Auto
Scale	10 dB/div
Reference	0 dB
System Bandwidth	Medium wide

1. Preset power level can be set to other than 0 dBm if desired. See [“Entering Source Power Level” on page 2-6](#) for more information.

NOTE

The measurement parameters that you enter will be retained in the analyzer's memory when the power is turned off, and will be restored when the power is turned back on.

NOTE

Refer to [Chapter 11, “Factory Preset State and Memory Allocation,”](#) for a comprehensive table of factory preset conditions.

**Entering
Frequency Range**

1. Press the **FREQ** key to access the frequency softkey menu.
2. To change the low end of the frequency range to 10 MHz, press **Start** **10** **MHz**.
3. To change the high end of the frequency range to 900 MHz, press **Stop** **900** **MHz**.
4. You can also set the frequency range by using the **Center** and **Span** softkeys. For instance, if you set the center frequency to 160 MHz and the span to 300 MHz, the resulting frequency range would be 10 to 310 MHz.

NOTE

When entering frequencies, be sure to terminate your numeric entry with the appropriate softkey to obtain the correct units. If you use the **ENTER** key to terminate a frequency entry, the units default to Hz.

The default displayed frequency resolution is kHz. You can change the resolution by pressing **FREQ** **Disp Freq Resolution**, and then selecting a new resolution.

**Entering Source
Power Level**

1. Press the **POWER** key to access the power level softkey menu.
2. To change the power level to 3 dBm, press **Level** **3** and **dBm** or **ENTER**.
3. To change the power level to -1.6 dBm, press **Level** **-1.6** **dBm** or **ENTER**.
4. To change the power level that will always be restored when you preset the analyzer, press **Pwr Level at Preset** **2.5** and **dBm** or **ENTER**. This entry does not affect the current power level.

**Scaling the
Measurement
Trace**

1. Press the **SCALE** key to access the scale menu.
2. To view the complete measurement trace on the display, press **Autoscale**.
3. To change the scale per division to 5 dB/division, press **Scale/Div** **5** **Enter**.
4. To move the reference position (indicated by the ► symbol on the left side of the display) to the first division down from the top of the display, press **Reference Position** **9** **Enter**. Figure 2-3 shows how each reference position is identified.
5. To change the reference level to 0 dB, press **Reference Level** **0** **Enter**.

Figure 2-3 Reference Positions

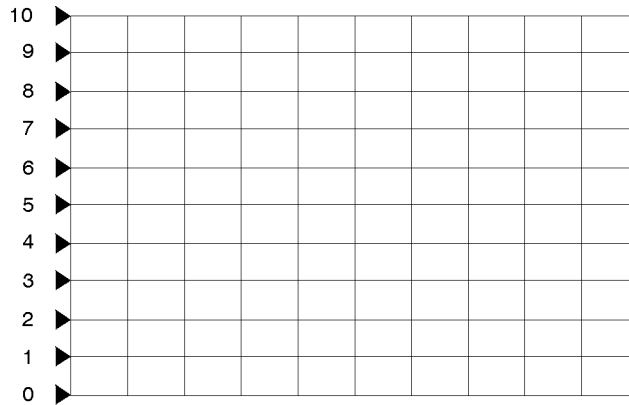

po652b_c

Entering the Active Measurement Channel and Type of Measurement

The **MEAS 1** and **MEAS 2** keys allow you to choose which measurement channels are active, and measurement parameters for the channels. When a particular measurement channel is selected, its display is brighter than the other channel, and any changes made to measurement parameters will affect only the selected measurement channel. (Some measurement parameters cannot be independently set on each measurement channel. For these parameters, both channels will be affected regardless of selected channel status.)

1. To measure S_{21} on measurement channel 1 and S_{11} on measurement channel 2, press the following keys:

PRESET **MEAS 1** **S21 Fwd Trans**

MEAS 2 **S11 Refl Port1**

2. Both channels' measurements are now visible on the analyzer's display screen. Note that the selected measurement channel's (channel 2) measurement trace is brighter than the other measurement channel's trace. Refer to [Figure 2-4](#).

Figure 2-4 Both Measurement Channels Active

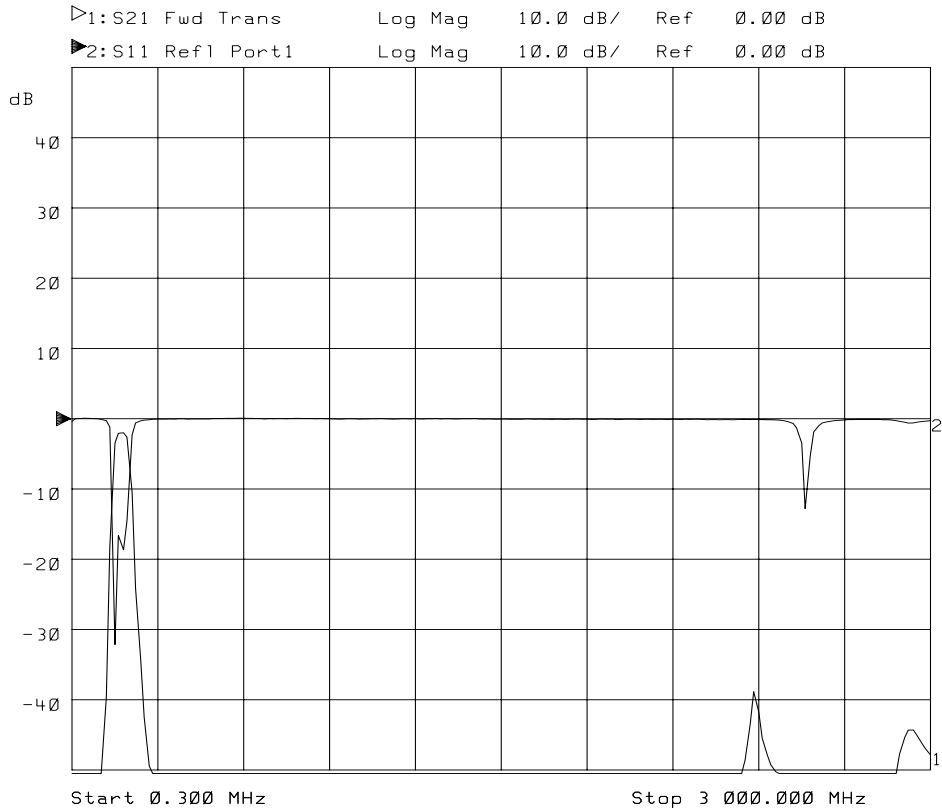

Viewing Measurement Channels

1. To view only the measurement channel 2 S₁₁ measurement, press **MEAS 1 Meas OFF**.
2. To view both measurement channels again, press **MEAS 1**.
3. To view both measurement channels separately on a split screen, press **DISPLAY More Display Split Disp FULL split**. Refer to [Figure 2-5, "Split Display."](#)

Figure 2-5 Split Display

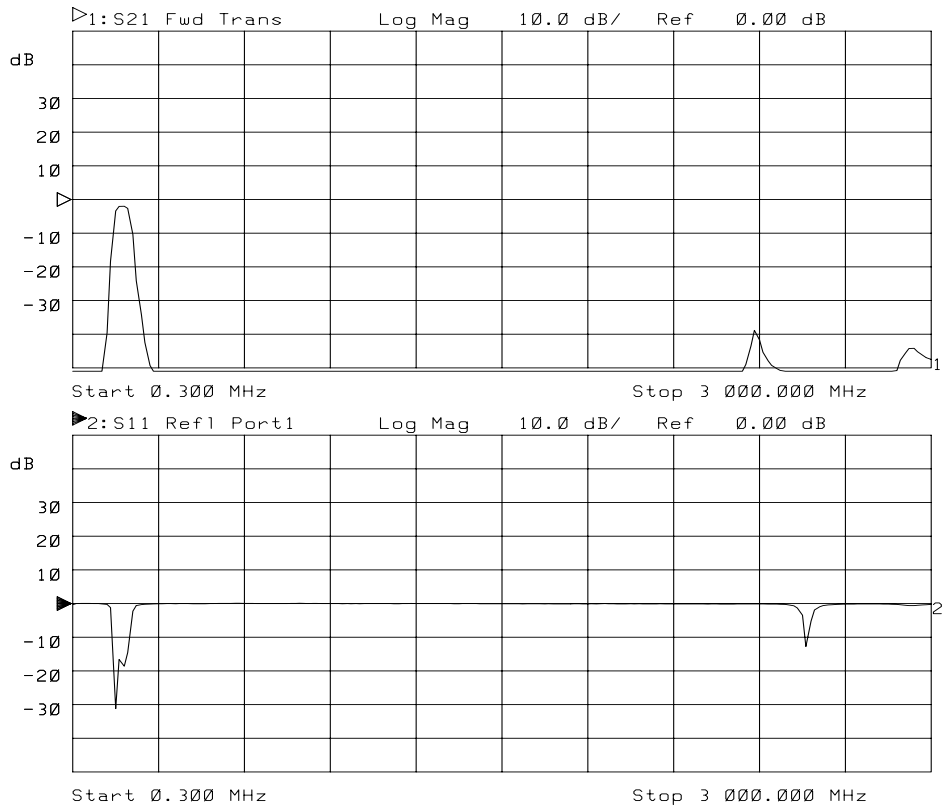

You have now learned how to enter common measurement parameters and how to manipulate the display for optimum viewing of your measurement. You can now proceed on to performing the operator's check, or refer to [Chapter 3, "Making Measurements,"](#) for detailed information on making specific types of measurements.

Performing the Operator's Check

The operator's check should be performed when you receive your instrument, and any time you wish to have confidence that the analyzer is working properly. The operator's check does not verify performance to specifications, but should give you a high degree of confidence that the instrument is performing properly if it passes.

The operator's check consists of making the following measurements with the cable that was supplied with your analyzer:

- S_{21} and S_{12}
- broadband power
- S_{11} and S_{22}
- S_{11} and S_{22} (with a 50 Ω or 75 Ω load, instead of the cable)

Equipment List

To perform the operator's check you will need the following:

- A known good cable such as the one that was supplied with your analyzer. The cable you use should have ≤ 0.5 dB of insertion loss up to 1.3 GHz and ≤ 0.75 dB of insertion loss from 1.3 to 3.0 GHz.
- A known good load (> 40 dB return loss) that matches the test port impedance of your analyzer such as one from calibration kit HP/Agilent 85032B/E (50 Ω) or HP/Agilent 85036B/E (75 Ω).

Make S21 and S12 Transmission Measurements

1. Connect the equipment as shown in [Figure 2-6](#). Use a known good cable such as the one that was supplied with your analyzer.

NOTE

The quality of the cable will affect these measurements; make sure you use a cable with the characteristics described in [“Equipment List.”](#)

Figure 2-6 Equipment Setup for Performing the Operator's Check

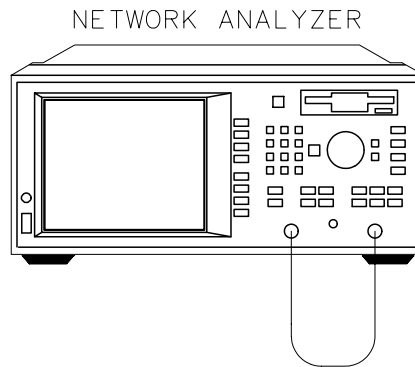

pp62es

2. Press **PRESET** (**User Preset** or **Factory Preset**). The instrument is automatically set up for an S_{21} measurement on measurement channel 1.
3. Press **SCALE** **.1** **Enter** .
4. Press **POWER** **0** **dBm** .
5. Press **CAL** **Default Response** .
6. Verify that the data trace falls within ± 0.5 dB of 0 dB. See [Figure 2-7](#) for a typical 8714ES result. The 8712ES should look similar, but end at 1300 MHz.

Figure 2-7 **Verify S_{21} Transmission Measurement**

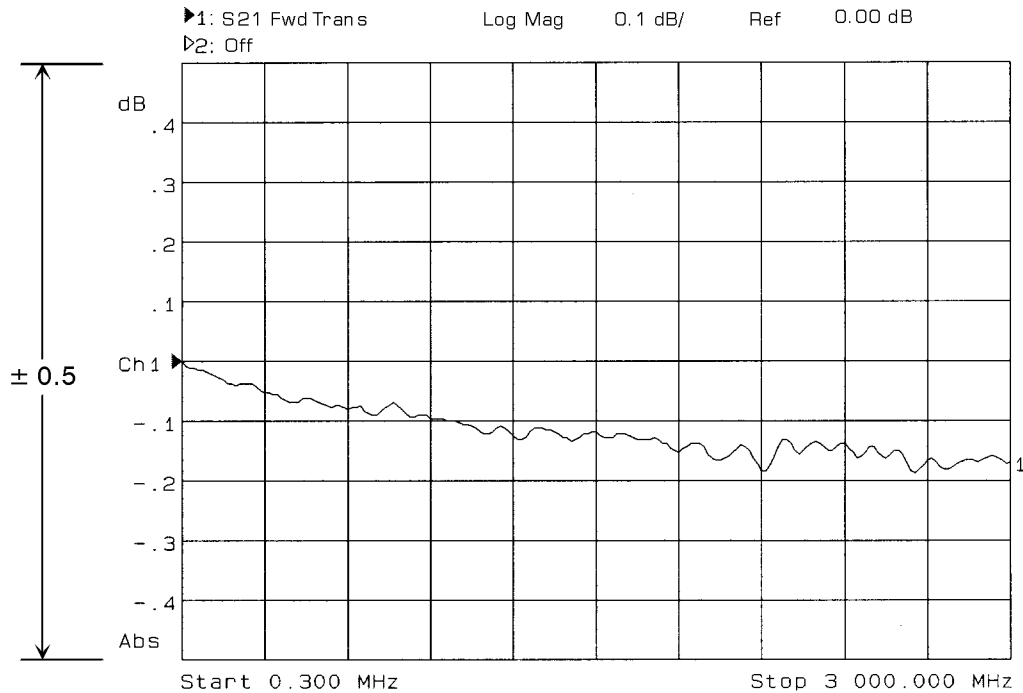

pp653es

7. Press **MEAS 1** **S12 Rev Trans** .
8. Press **CAL** **Default Response** .
9. Verify that the data trace falls within ± 0.5 dB of 0 dB. See [Figure 2-7](#) for a typical 8714ES result. (Although this figure is from an S_{21} measurement, the results of your S_{12} measurement should look similar.) The 8712ES should look similar, but will end at 1300 MHz.

Make a Broadband Power Measurement

1. Leave the cable connected to the analyzer as shown in [Figure 2-6](#).

NOTE

The quality of the cable will affect these measurements; make sure you use a cable with the characteristics described in [“Equipment List” on page 2-10](#).

2. Press **MEAS 1** **More** **Power** **FREQ** **Start** **10** **MHz** **SCALE** **1** **Enter** .
3. Press **POWER** **0** **dBm** (unless done in the previous measurement).
4. Verify that the data trace is within ± 2 dB of 0 dBm. See [Figure 2-8](#) for a typical 8714ES result. The 8712ES should look similar, but end at 1300 MHz.

Figure 2-8

Verify Broadband Power Measurement

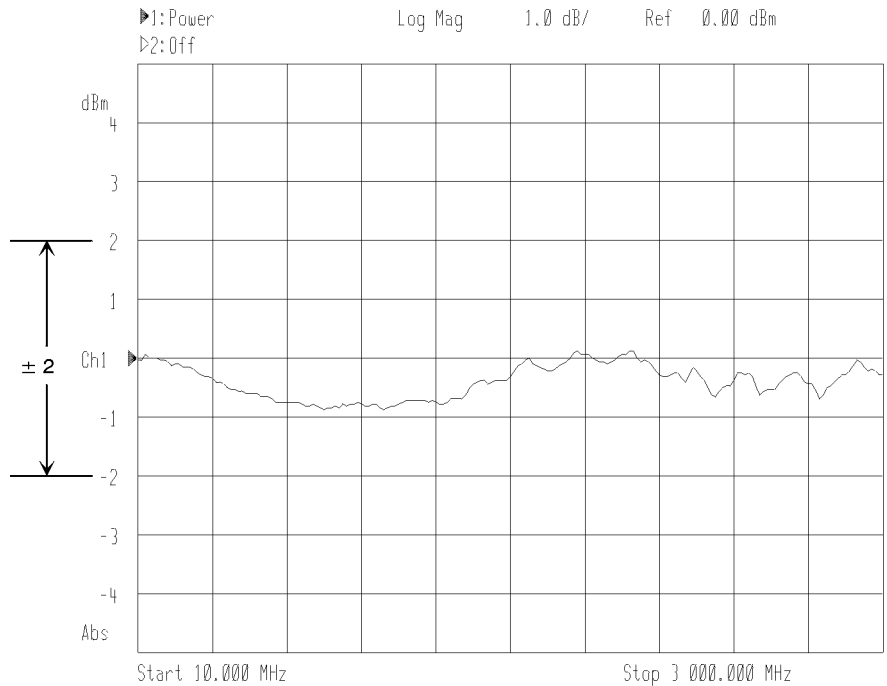

pp638es

Make S11 and S22 Reflection Measurements

1. Leave the cable connected to the analyzer as shown in [Figure 2-6](#).

NOTE

The quality of the cable will affect these measurements; make sure you use a cable with the characteristics described in [“Equipment List”](#).

2. Press **PRESET** (**User Preset** or **Factory Preset**) **MEAS 1**
S11 Refl Port1 .
3. Press **SCALE** **10** **Enter**
4. Press **POWER** **0** **dBm** .
5. Press **CAL** **Default 1-Port** .
6. Verify that the data trace falls completely below -16 dB. See [Figure 2-9](#) for a typical 8714ES result. The 8712ES should look similar, but end at 1300 MHz.

Figure 2-9 Verify S_{11} Reflection Measurement

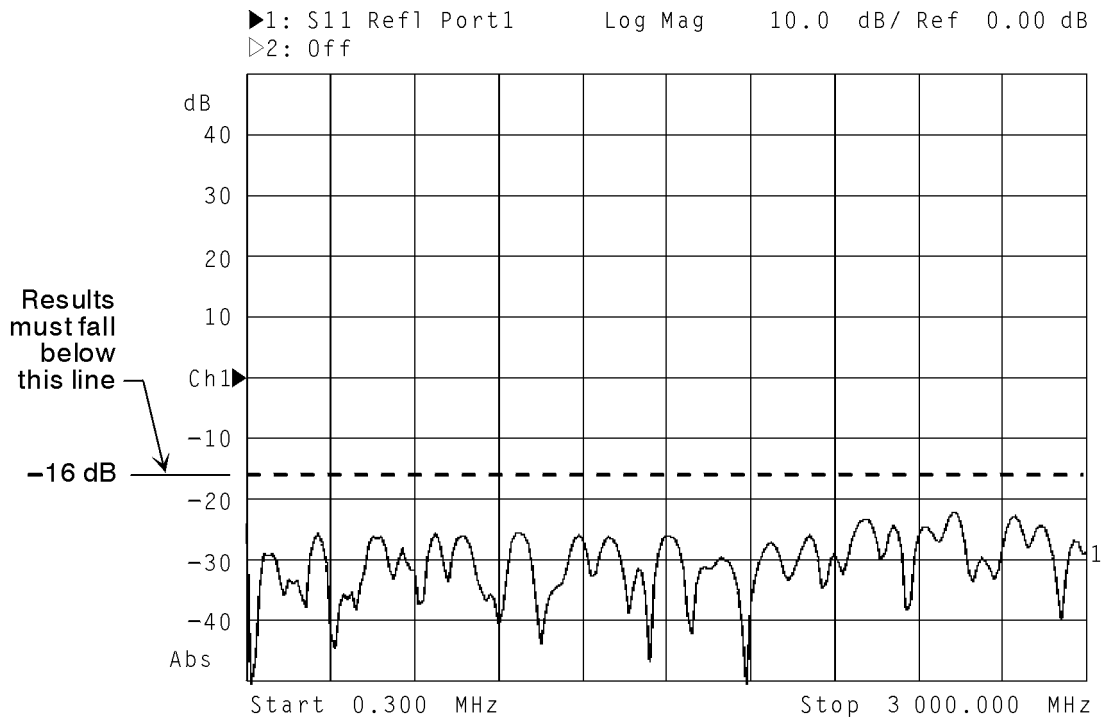

pp655es

7. Press **MEAS 1** **S22 Refl Port2** .
8. Press **CAL** **Default 1-Port** .
9. Verify that the data trace falls completely below -16 dB. See [Figure 2-9](#) for a typical 8714ES result. (Although this figure is from an S_{11} measurement, the results of your S_{22} measurement should look similar.) The 8712ES should look similar, but will end at 1300 MHz.
10. Disconnect the cable and connect a known good load to port 2 as shown in [Figure 2-10](#).

Figure 2-10 **Connect the Load to Port 2**

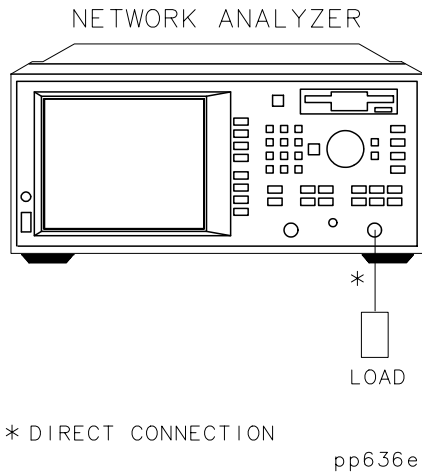



11. Verify that the data trace falls below -30 dB. If the data trace is off the screen, press **SCALE** **Reference Level** and the  key until the trace moves up onto the screen.
12. Disconnect the load from port 2 and connect it to port 1 as shown in [Figure 2-11](#).

Figure 2-11 **Connect the Load to Port 1**

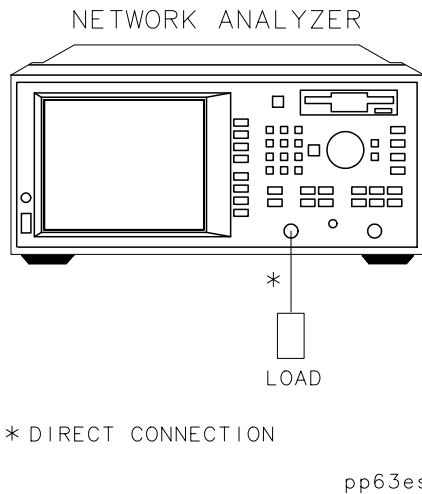

13. Press **MEAS 1** **S11 Refl Port1** .

14. Verify that the data trace falls below -30 dB. If the data trace is off the screen, press **SCALE** **Reference Level** and the  key until the trace moves up onto the screen.

This concludes the operator's check. However, further confidence can be obtained by performing the following:

- Measure a known filter to verify that its measured response is the same as is expected. (A 175 MHz filter is supplied with the analyzer.) Verify both the frequency accuracy and noise floor.
- Check broadband response with the filter using conversion-loss mode (same as B*/R*).
- If the analyzer's frequency accuracy is critical for your application, verify a CW frequency using a frequency counter. Verify to $\pm 0.005\%$ accuracy (for example, ± 2500 Hz at 500 MHz). Ensure that the analyzer is placed in trigger-hold mode (press **MENU** **Trigger Hold**) to measure frequencies.

If the Analyzer Fails the Operator's Check

First, repeat the operator's check using a different cable and load to eliminate these as a possible cause of failure. If your analyzer does not meet the criteria in the operator's check, your analyzer may need adjustment or servicing. Contact any Agilent Technologies sales or service office for assistance. Refer to [Table 9-10, "Agilent Technologies Sales and Service Offices,"](#) in [Chapter 9](#) for the nearest office. Before shipping your analyzer, fill out and attach the blue repair tag, located at the back of the analyzer's *Service Guide*.

3 **Making Measurements**

Introduction

This chapter provides an overview of basic network analyzer measurement theory, a section explaining the typical measurement sequence, a segment describing the use of the **BEGIN** key, and detailed examples of the following measurements:

- “Measuring S-Parameters using a Two-Port Calibration” on page 3-20
- “Measuring S21 Forward Transmission using an Enhanced Response Calibration” on page 3-42
- “Measuring S11 Reflection Port 1 using a One-Port Calibration” on page 3-49
- “Making a Power Measurement using Broadband Detection” on page 3-57
- “Measuring Conversion Loss” on page 3-62
- “Making Measurements with the Auxiliary Input” on page 3-68
- “Measuring Group Delay” on page 3-70
- “Measuring Impedance using the Smith Chart” on page 3-74
- “Measuring Impedance Magnitude” on page 3-81

Measuring Devices with Your Network Analyzer

This section provides a basic overview of how the network analyzer measures devices. The analyzer has an RF signal source that produces an incident signal that is used as a stimulus to the device under test. Your device responds by reflecting a portion of the incident signal and transmitting the remaining signal. If the device is passive, some of the transmitted signal will be absorbed, indicating a “lossy” device. If the device is active, the transmitted signal may be amplified, indicating that the device has gain. [Figure 3-1](#) shows how a device under test (DUT) responds to an RF source stimulus.

Figure 3-1 DUT Response to an RF Signal

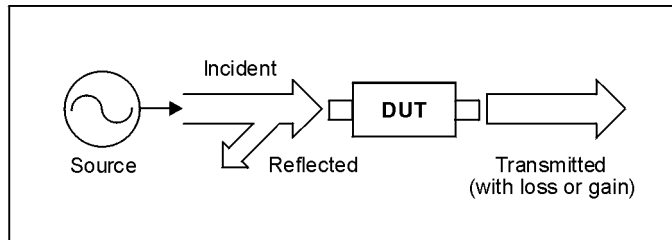

pp639es

Refer to [Figure 3-2, “Simplified Block Diagram,”](#) for the following discussion regarding detection schemes and modes. The forward transmitted signal (routed to input B) and the reflected signal (input A) are measured by comparison to the incident signal. The reverse transmitted signal (routed to input A) and the reflected signal (input B) are also measured by comparison to the incident signal. The analyzer couples off a small portion of the incident signal to use as a reference signal (routed to input R). Sweeping the source frequencies, the analyzer measures and displays the response of your test device.

Figure 3-2 **Simplified Block Diagram**

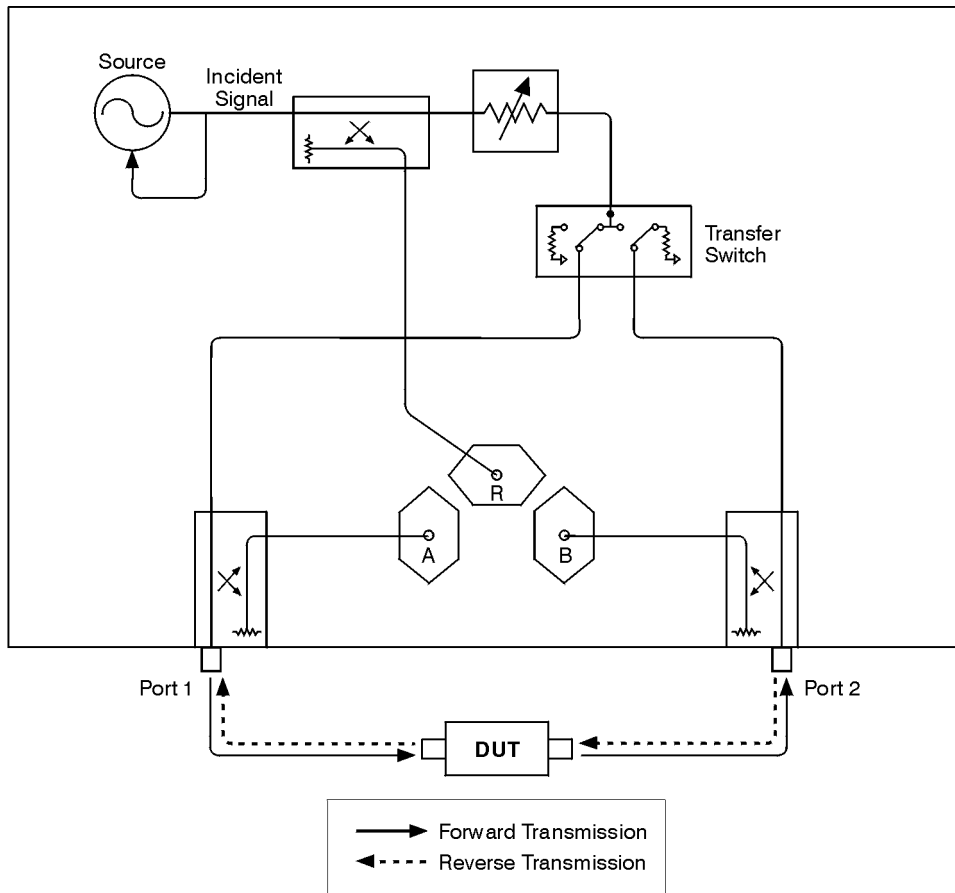

pp613es

This page intentionally left blank.

Refer to [Figure 3-3, “Block Diagram,”](#) for the following discussion. The network analyzer receiver has two signal detection modes:

- broadband detection mode
- narrowband detection mode There are two internal broadband detectors: B* and R*. External broadband detectors can also be used when connected to the X and Y ports on the rear panel of the analyzer. When the network analyzer is in the broadband detection mode, it measures the total power of all signals present at these measurement ports, independent of signal frequency. This enables the characterization of frequency translation devices such as mixers, receivers, and tuners, where the RF input and output frequencies are not the same. [Figure 3-3](#) labels the transmitted signal for broadband detection input as B*, and the reference signal as R*.

When the network analyzer is in the narrowband detection mode, the receiver is tuned to the source frequency. This technique provides greater dynamic range by decreasing the receiver's bandwidth. [Figure 3-3](#) shows receiver B as the narrowband detection input for the forward transmitted signal and the reverse reflected signal. Receiver A acts as the narrowband detection input for the reverse transmitted signal and the forward reflected signal. Receiver R is shown as the narrowband detection input for the reference signal.

Figure 3-3 **Block Diagram**

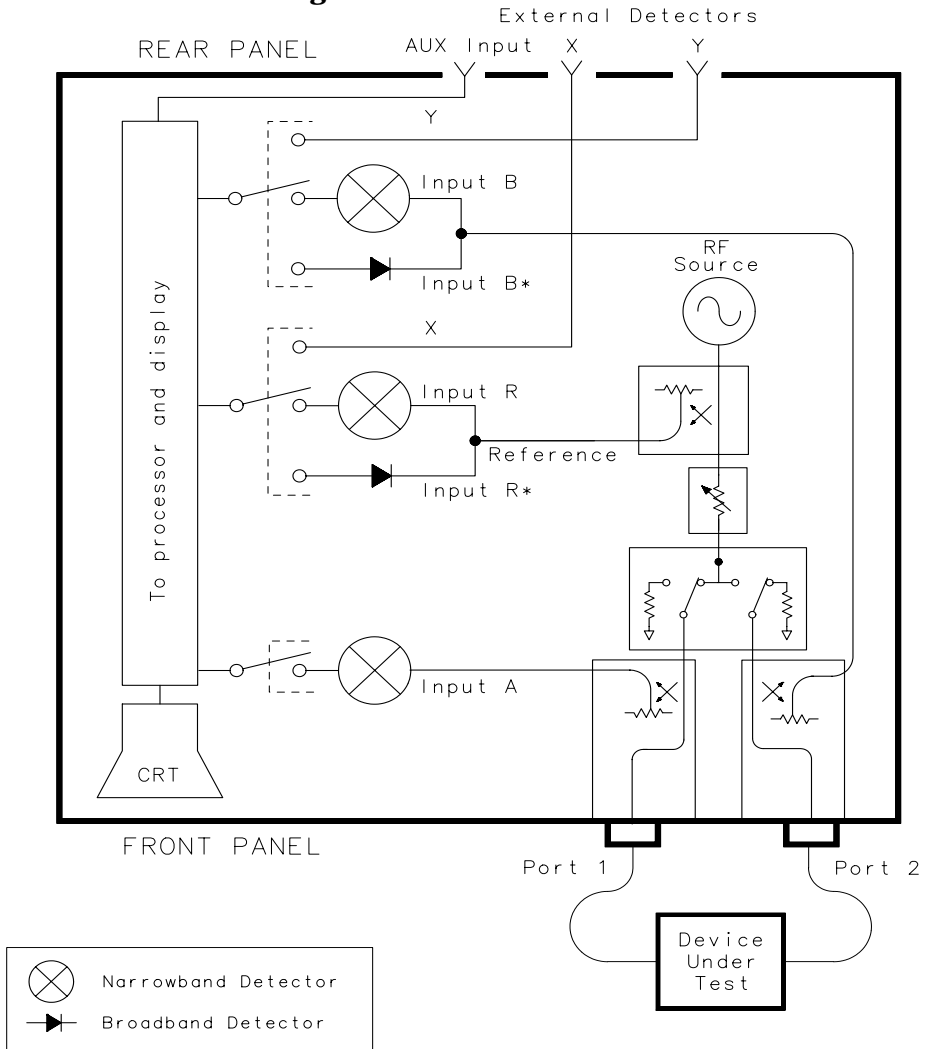





pp615es

The following table shows the correlation between different types of measurements, input channels and signals.

Measurement	Detection Mode	Input Detectors	Input Signals	Source Direction
S_{21} Forward Transmission	Narrowband	B/R	transmitted/ incident	Forward
S_{12} Reverse Transmission	Narrowband	A/R	transmitted/ incident	Reverse
S_{11} Reflection Port 1	Narrowband	A/R	reflected/ incident	Forward
S_{22} Reflection Port 2	Narrowband	B/R	reflected/ incident	Reverse
Power	Broadband	B*	transmitted	Forward
Conversion Loss	Broadband	B*/R*	transmitted/ incident	Forward

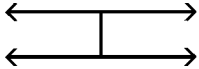
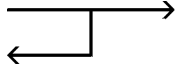
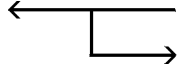
The Measurement Display Icon

The measurement display icon, located in the lower right corner of the analyzer's display, indicates the signal path direction of the current measurement. The look of this icon will vary, depending on the type of measurement, calibration, and sweep time that have been selected. The following table contains the icons, along with an explanation of each. (If both measurement channels are active, you may see variations of these icons.)

Measurement Display Icon	Icon Appears on the Analyzer's Display When Measuring:
	<p>Any of the four S-parameters (with two-port calibration) when sweep time is less than 3.0 seconds.</p>
	<p>Either of the two forward S-parameters (with two-port calibration) when sweep time is more than 3.0 seconds.</p>
	<p>Either of the two reverse S-parameters (with two-port calibration) when sweep time is more than 3.0 seconds.</p>
	<p>S_{11} (not with two-port calibration) or calibration standards.¹</p>
	<p>S_{22} (not with two-port calibration) or calibration standards.¹</p>
	<p>S_{21} or fault location/SRL (not with two-port calibration), power, conversion loss, or calibration standards.¹</p>
	<p>S_{12} or fault location/SRL (not with two-port calibration), or calibration standards.¹</p>

1. When calibration standards are being measured, a “Cx” is displayed on the annotation line, indicating non-corrected, non-simultaneous measurements are being made.

Measuring S-Parameters

Figure 3-4 Measuring S-Parameters

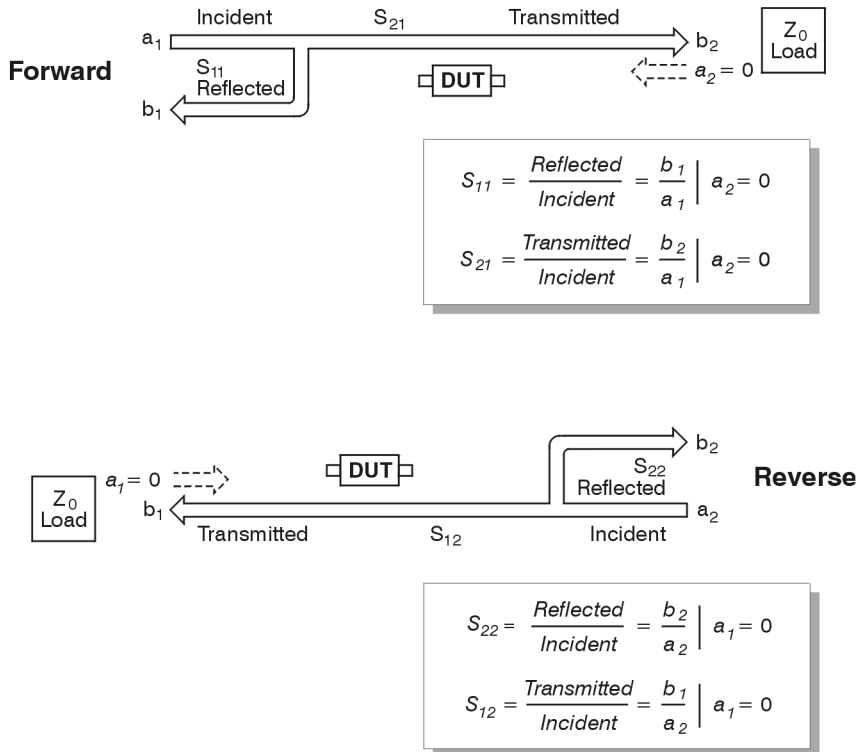

pp616es

Refer to [Figure 3-4](#) for the following discussion of S-parameters. S-parameters are used to completely describe the electrical behavior of a linear two-port device that operates at high frequencies. An N-port device has N^2 S-parameters. So, a two-port device has four S-parameters. The numbering convention for S-parameters is that the first number following the “S” is the port where energy emerges, and the second number is the port where energy enters. So, S_{21} is a measure of power coming out port 2 as a result of applying an RF stimulus to port 1. When the numbers are the same (e.g., S_{11}), it indicates a reflection measurement.

NOTE

When making any type of S-parameter measurement with a two-port calibration, the analyzer takes both a forward and a reverse sweep while collecting data.

S_{11} and S_{21} are determined by measuring the magnitude and phase of the incident, reflected, and transmitted signals when the output is terminated in a perfect Z_0 (a load that equals the characteristic impedance of the test system). This condition guarantees that a_2 is zero. S_{11} is equivalent to the input complex reflection coefficient or impedance of the DUT, and S_{21} is the forward complex transmission coefficient.

Likewise, by placing the source at port 2 and terminating port 1 in a perfect load (making a_1 zero), S_{22} and S_{12} measurements can be made. S_{22} is equivalent to the output complex reflection coefficient or output impedance of the DUT, and S_{12} is the reverse complex transmission coefficient.

The accuracy of S-parameter measurements depends greatly on how good a termination we apply to the port not being stimulated. Anything other than a perfect load will result in a_1 or a_2 not being zero (which violates the definition for S-parameters). When the DUT is connected to the test ports of a network analyzer and you don't account for imperfect test port match, you haven't satisfied the condition of a perfect termination. For this reason, two-port error correction, which corrects for source and load match, is very important for accurate S-parameter measurements (two-port correction is covered in more detail in [Chapter 6, "Calibrating for Increased Measurement Accuracy"](#)).

Attenuation and Amplification in a Measurement Setup

The measurement setup that you use may require attenuation or amplification. The following sections describe when to use them.

When to Use Attenuation

- For accurate measurements, use external attenuation to limit the power at the input port to +10 dBm (for narrowband-detection measurements) or +16 dBm (for broadband-detection measurements).

CAUTION

Always use attenuation on the input port if your test device's output power exceeds the receiver damage limit of +26 dBm or ± 30 Vdc.

- For information on how to reduce mismatch errors, see [“Reducing Mismatch Errors” on page 5-15](#).

When to Use Amplification

- For accurate measurements, amplification may be needed on the analyzer's output port. Use amplification when your test device requires input power that exceeds the analyzer's maximum specified output power.

NOTE

If you use an amplifier between the analyzer's output port and your DUT, you won't be able to measure the input match (S_{11}) of your DUT.

The maximum specified output power is dependent upon the option configuration of your analyzer as well as the frequency range of your test setup. It ranges from +4 to +13 dBm. See [Chapter 9, “Specifications,”](#) to determine the maximum specified output power of your analyzer.

When to Change the System Impedance

Your analyzer has a system characteristic impedance of either 50 or 75 ohms, yet may be changed to the alternate impedance. If using minimum-loss pads for impedance conversions, the alternate impedance should be selected so that the measurement results are displayed relative to the conversion impedance.

For example, if you have a 50 ohm instrument and are making 75 ohm measurements, you may be using 50 to 75 ohm minimum-loss pads. Measurement results can be reported relative to 75 ohms, not 50 ohms, if the alternate system impedance is selected. This includes marker readouts, Smith chart results, or SRL impedance computations (Option 100).

To change the system impedance, press the following keys on the analyzer:

CAL

More Cal

System Z0

50 Ω or **75 Ω**

The built-in cal kit selections will be converted to the selected system impedance.

The Typical Measurement Sequence

A typical measurement consists of performing four major steps:

Step 1. Enter the Measurement Parameters

The easiest way to set up the analyzer's parameters for a simple measurement is to use the **BEGIN** key. When this key is selected, the analyzer automatically sets up a generic set of parameters to match the device type you choose. (See [“Using the BEGIN Key to Make Measurements”](#) next, in this chapter.)

For measurements that require you to enter your own specific measurement parameters (such as frequency range, source power level, number of points, and sweeptime), use the instrument's keys to enter your selections rather than using the **BEGIN** key. See the measurement examples, located later in this chapter.

Step 2. Calibrate the Analyzer

Your analyzer can provide highly accurate measurements without performing any additional user-defined calibrations if certain conditions are met. [Chapter 6, “Calibrating for Increased Measurement Accuracy,”](#) explains when additional user-defined calibration is necessary.

Step 3. Connect the Equipment

Connect the DUT and any other required test equipment. See the measurement examples later in this chapter for typical equipment setup configurations.

Step 4. View and Interpret the Measurement

Use the **SCALE**, **DISPLAY**, and **FORMAT** functions to optimize viewing of the measurement results.

Markers, limit lines, and hard copies of the display are common means of interpreting measurement results.

See [Chapter 4, “Using Instrument Functions,”](#) for detailed information on using instrument functions to view and interpret your measurements.

Using the BEGIN Key to Make Measurements

Figure 3-5 **The BEGIN Key**

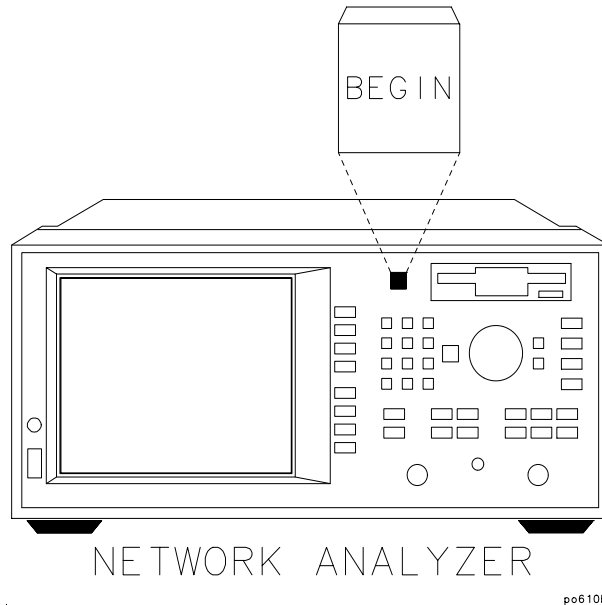

The **BEGIN** key allows you to quickly and easily configure the analyzer (from the **PRESET** condition) to measure the following:

- amplifiers
- filters
- broadband passive devices (a cable, for example)
- mixers
- cable fault location and structural return loss (Option 100 only)

Configuring basic measurements from the **BEGIN** key helps you ensure correct instrument setup. The analyzer guides you through the initial steps and configures itself for the device type you select.

BEGIN Key Overview

The **BEGIN** key sets up a generic instrument state for the testing of various types of devices.

The **BEGIN** key has two different behaviors, depending on whether you are selecting a new *device* type, or a new *measurement* type.

Selecting a New Device

When you use the **BEGIN** key to select a new device type and measurement, the analyzer does the following:

- presets the analyzer (except for external reference parameters, and trigger mode)
- takes a sweep
- autoscales the measurement
- places a marker on the maximum or minimum point (depending on the type of measurement)
- makes the marker active
- modifies the sweep time (Option 100 only)

See [Table 3-1, “Measurement Configurations from the BEGIN Key,”](#) for a table of parameters for each measurement type.

Selecting a New Measurement

Once you have selected your device, you can use the softkeys to select the measurement you wish to make. When you select a new measurement, a preset is not done. It is assumed that you are simply changing measurement types and that you may have already changed some of the analyzer's parameters (such as frequency, power, etc.) for your DUT. In this situation, you would probably not want these parameters changed for subsequent measurements.

NOTE

If the new measurement selected is a broadband measurement such as power, or conversion loss, the start frequency is limited to at least 10 MHz. Therefore, if your customized setup contains a start frequency below 10 MHz and you choose power, or conversion loss, the start frequency will be changed to 10 MHz. The stop frequency will remain unchanged, unless it was set to below 10 MHz.

The BEGIN Key and Measurement Channels

The **BEGIN** key is designed to work when measurement channel 1 is active. However, it does change the mode of measurement channel 2 as well.

If measurement channel 2 is active when the **BEGIN** key is used to select a new *device* type, measurement channel 2 is turned off, and measurement channel 1 is made active.

If measurement channel 2 is active when the **BEGIN** key is used to select a new *measurement* type, measurement channel 2 will be left on *and* active. However, the analyzer then proceeds to set up channel 1 for the requested measurement type, even though channel 2 is the active channel.

Using the BEGIN Key to Configure Measurements

This procedure shows you how to configure the network analyzer for measurements.

1. Press **PRESET** (**User Preset** or **Factory Preset**). Presetting the instruments puts it into a known state with predefined parameters.
2. Press **BEGIN** and then use a softkey to select the type of device that you will be measuring (amplifier, filter, broadband passive device, mixer, or cable—Option 100 only).
3. Connect your test device to the network analyzer.
4. Use the softkeys to select the type of measurement you want to make:
 - Press **S11 Refl Port1**, **S21 Fwd Trans**, **S12 Rev Trans**, or **S22 Refl Port2** if you want to measure a particular S-parameter. (S-parameter selections are under the **Amplifier**, **Filter**, **Broadband Passive**, and **Mixer** menus.)
 - Press **Power** if you want to measure the RF power of a device. (The **Power** selection is under the **Amplifier** menu.)
 - Press **Conversion Loss** if you want to measure the conversion loss of a device. (The **Conversion Loss** selection is under the **Mixer** menu.)
 - Press **SRL** (Option 100 only) if you want to measure the structural return loss of a cable. (The **SRL** selection is under the **Cable** menu.)

- Press **Fault Location** (Option 100 only) if you want to measure the cable fault location. (The **Fault Location** selection is under the **Cable** menu.)

Depending on your selection, the analyzer is set to one of the following configurations. (The **SRL** and **Fault Location** configurations are discussed in the *Option 100 User's Guide Supplement*.)

Table 3-1 Measurement Configurations from the BEGIN Key

	S₁₁ Refl Port 1	S₂₁ Fwd Trans	S₁₂ Rev Trans	S₂₂ Refl Port 2	Power	Conversion Loss
Frequency Range (8712ES)	0.300 MHz to 1300 MHz	0.300 MHz to 1300 MHz	0.300 MHz to 1300 MHz	0.300 MHz to 1300 MHz	10 MHz to 1300 MHz	10 MHz to 1300 MHz
Frequency Range (8714ES)	0.300 MHz to 3000 MHz	0.300 MHz to 3000 MHz	0.300 MHz to 3000 MHz	0.300 MHz to 3000 MHz	10 MHz to 3000 MHz	10 MHz to 3000 MHz
Measurement Channel 1	S ₁₁	S ₂₁	S ₁₂	S ₂₂	Power	Conversion Loss
Detection Mode	Narrowband	Narrowband	Narrowband	Narrowband	Broadband Internal	Broadband Internal
Measurement Paths	A/R	B/R	A/R	B/R	B*	B*/R*

The following measurement configurations apply to *all* of the measurement types in the previous table:

Power Level	Factory preset or user preset power level ¹
Measurement Channel 2	Off
Format	Log Mag
Number of Points	201
Sweep Time Mode	Auto
Sweep Triggering	Continuous
Averaging	Off
System Bandwidth	Medium Wide

1. Factory preset power level is user-defined by using the "Pwr Level at Preset" softkey. The factory default is 0 dBm.

AUTOST files

When the analyzer's power is turned on, it first checks for an IBASIC autostart file (AUTOSTART.BAS) on the non-volatile RAM disk and then on the 3.5" disk. If found, the file is loaded and run. This feature simplifies the task of turning on an automated test station at the beginning of a working day or test session. To manually load and run an autostart file, press **BEGIN** **Autost** .

The User BEGIN Function

The **User BEGIN** softkey gives you the capability to redefine the **BEGIN** key menu and install user-defined macro functions. Use this key to define macros such as:

- softkeys to implement *fast* save/recall
- softkeys to implement most-used functions or features
- softkeys to implement often-used features that involve a number of steps

Macros must be defined with an IBASIC program. If no **User BEGIN** program is currently installed (either by AUTOST or **Recall Program**), the analyzer will automatically create a default program.

User BEGIN on OFF selects the **BEGIN** key menu to "user" mode when on, and to normal operation when off.

Once you have changed the **User BEGIN** mode to on, the same menu will be displayed for subsequent key presses of the **BEGIN** hardkey. (This is not true if your IBASIC program has changed. If the program has changed, the **User BEGIN** mode is reset to off.)

Use of the **User BEGIN** function does not restrict access to any normally available instrument feature (such as marker functions), nor does this key affect sweep update rates.

Refer to the IBASIC example programs provided on the *Example Programs Disk* for implementation requirements. Keystroke recording may be used to modify or update **User BEGIN** programs.

See the *Automating Measurements User's Guide Supplement* for more information.

Measuring S-Parameters using a Two-Port Calibration

This section describes how to perform a two-port calibration. Once done, this calibration can be used with all types of S-parameter measurements. It should be noted that other types of error correction, though not as accurate as a two-port calibration, allow faster measurement speed. Therefore, if measurement speed is of more importance than highest accuracy, you may want to use a different type of error correction than the two-port calibration. See the table below for a list of all possible calibration choices for S-parameter measurements.

TIP

An optimum calibration is critical for achieving best measurement accuracy. Refer to [Chapter 6, “Calibrating for Increased Measurement Accuracy,”](#) for detailed information about all of the various aspects of calibration.

Table 3-2

Calibration Choices for S-Parameter Measurements

Measurement Type	Calibration Choices
S_{11} Refl Port 1 <i>or</i> S_{22} Refl Port 2	Default 1-Port Default 2-Port User 1-Port User 2-Port
S_{21} Fwd Trans <i>or</i> S_{12} Rev Trans	Default Response Default 2-Port User Response: Response Response & Isolation Enhanced Response User 2-Port Normalize

Enter the Measurement Parameters

1. Press the following keys on the analyzer:

PRESET (**User Preset** or **Factory Preset**) **MEAS 1**

2. Press the softkey for any type of S-parameter measurement.

NOTE

This example measurement uses the default instrument parameters for the S-parameter measurement you selected. If your particular measurement requires different parameters (such as frequency range, source power level, number of data points, and sweeptime), enter them now.

Perform a User Two-Port Calibration

This example describes how to perform a two-port calibration. This calibration uses known standards to correct for directivity, source match, load match, and frequency response errors when using narrowband detection. To correct for errors caused by crosstalk, refer to the definition of a user two-port calibration in [Chapter 6](#).

When you perform a two-port calibration, the analyzer performs correction at each data point across the selected frequency band. The default number of data points per sweep is 201, but you can select any number between 3 and 1601. Interpolation recalculates the error correction array for reduced frequency spans. If the frequency span is increased, the calibration is invalidated and the default two-port calibration is automatically restored.

To perform a two-port calibration, you will need one of the following calibration kits depending on the nominal impedance of your analyzer:

Making Measurements
 Measuring S-Parameters using a Two-Port Calibration

Cal Kit Model Number	Impedance	Connector Type	For Use with Male Test Ports	For Use with Female Test Ports
85039B	75 Ω	type-F	✓	✓
85036B	75 Ω	type-N	✓	✓
85036E	75 Ω	type-N		✓
85032B	50 Ω	type-N	✓	✓
85032E	50 Ω	type-N		✓
85031B	50 Ω	APC-7	N/A	N/A
85033D	50 Ω	3.5 mm	✓	✓
85038A	50 Ω	7-16	✓	✓
85038F	50 Ω	7-16	✓	
85038M	50 Ω	7-16		✓

NOTE

By convention, cal kit labels in the analyzer indicate the sex of the *port* with which they are used. For example, the default cal kit for the analyzer is type-N *female* because the front panel RF ports are female (the calibration standards, in turn, have male connectors).

Calibrating for Insertable Devices

When measuring a through-standard during calibration, the test ports normally mate directly together. For example, two cables with the appropriate connectors can be connected directly without a through-adaptor, resulting in a zero-length through-standard. An insertable device is a device that can be inserted in place of a zero-length through-standard. It has the same type of connector on each port, but with a different sex, or the same type of sexless connector on each port (APC-7, for example).

Chapter 6 provides detail about when a user-defined calibration is necessary, and information about other calibrations available for S-parameter measurements. If you wish to perform a two-port calibration on your insertable device, execute the following steps:

1. Select calibration kits for both ports: since port 1 will use the default calibration kit (female type-N), this selection is already made for you. For port 2, press **CAL** **More Cal** **Cal Kit** and use the front panel knob or the **HOME** **LEFT** keys to highlight Port 2 in the display's table. Press **Type-N(m)** .
2. Press **Prior Menu** **Prior Menu** **User 2-Port** **User 2-Port** . If you want to correct for crosstalk errors, toggle the **Isolation on OFF** key ON (for more information about isolation, refer to the definition of a user two-port calibration in Chapter 6).
3. When the instrument prompts you to connect a through cable, insert a cable with type-N(m) connectors between port 1 and port 2 as shown in the Figure 3-6. Press **Measure Standard** . When done, disconnect the cable from port 1 but leave it connected to port 2.
4. The instrument prompts you to connect three standards (open, short, and load) to port 1 as shown in the graphic on the next page.

Figure 3-6 Through-Cable Connection

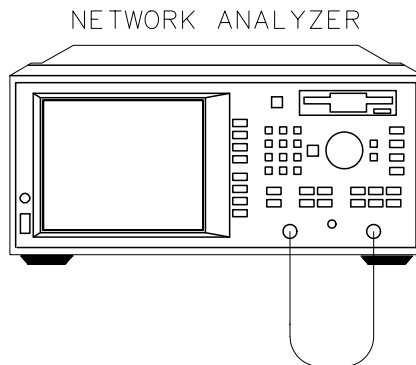

Making Measurements
Measuring S-Parameters using a Two-Port Calibration

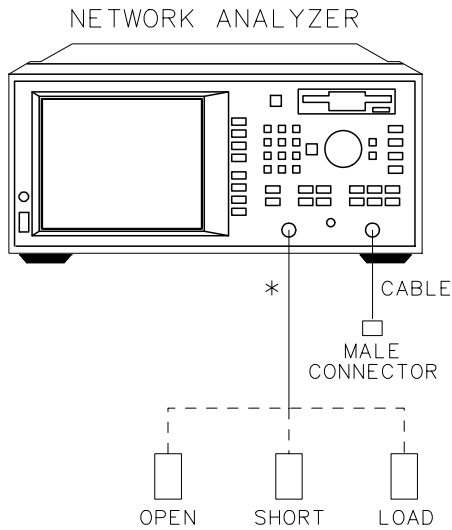

pp621es

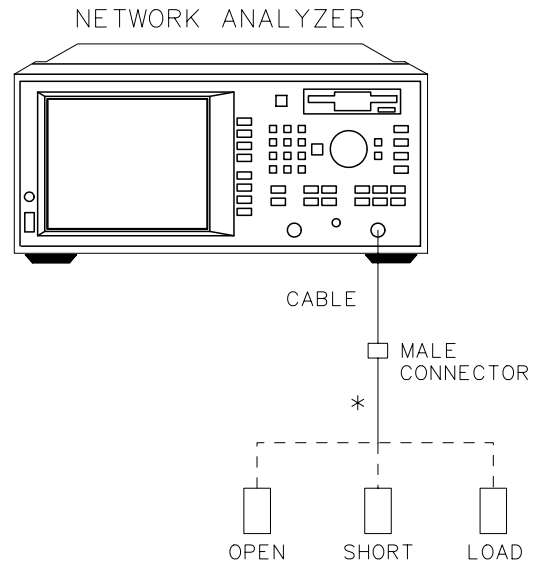

pp622es

Port 1: Open, Short, Load Connections

Port 2: Open, Short, Load Connections

5. Press **Measure Standard** after connecting each standard.
6. Next, the instrument prompts you to connect three standards (open, short, and load) to port 2. Instead of connecting the standards directly to port 2, connect them to the open end of the cable. This end of the cable will become the calibrated port 2 for measurements. See the graphic above.
7. The analyzer will measure each standard and then calculate new calibration coefficients. The message "Calibration complete." will appear for a few seconds when the analyzer is done calculating the new error correction array.

NOTE

Changing sweep frequencies (and other source parameters) may affect your calibration. See [Chapter 6](#) for more information.

Connect the DUT.

Figure 3-7

Equipment Setup for an S-Parameter Measurement of an Insertable Two-Port Device

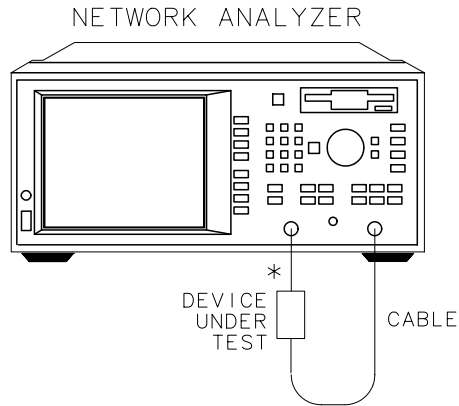

* DIRECT CONNECTION

pp64es

View and Interpret the S-Parameter Measurement Results.

1. To view the entire measurement trace on the display, press **SCALE** **Autoscale**
2. To interpret the measurement, refer to other S-parameter measurement examples later in this chapter.

Calibrating for Noninsertable Devices

A noninsertable device is one that cannot be inserted in place of a zero-length through-standard. It has the same connectors on each port (type and sex) or has a different type of connector on each port (SMA on one port, and type-N on the other, for example). The following two calibration methods are available for noninsertable devices:

- swap equal adapters
- modify the calibration kit definition of the through standard

Method A: Swap Equal Adapters.

In the following example, the noninsertable device is type-N, with female input and output connectors.



With this method, you use two precision matched adapters which are “equal.” To be equal, the adapters must have the same match, characteristic impedance (Z_0), insertion loss, and electrical delay. The adapters in most HP/Agilent calibration kits have matched electrical lengths, even if the physical lengths appear different.

NOTE

For analyzers with 50 ohm input impedance only: in the 50 ohm type-N calibration kit (85032B), there are four equal adapters: two APC-7 to type-N(f), and two APC-7 to type-N(m). To create adapter A in the following example, connect an APC-7-to-type-N(f) adapter with an APC-7 to type-N(m) adapter. To create adapter B, connect two APC-7 to type-N(m) adapters.

NOTE

By convention, cal kit labels in the analyzer indicate the sex of the port with which they are used. For example, the default cal kit for the analyzer is type-N *female* because the front panel RF ports are female (the calibration standards, in turn, have male connectors).

1. Connect a test cable with type-N(m) connectors to port 2.
2. To select calibration kits for both ports, press **CAL** **More Cal Cal Kit**, and use the front panel knob or the   keys to highlight Port 1 in the display's table. Press **Type-N(m)**. Now, highlight Port 2 and again press **Type-N(m)**.
3. Connect adapter A (type-N(m) to type-N(f)) to port 1.

4. Press **Prior Menu** **Prior Menu** **User 2-Port** **User 2-Port** . If you want to correct for crosstalk errors, toggle the **Isolation on OFF** key ON (for more information about isolation, refer to the definition of a user two-port calibration in [Chapter 6](#)).
5. When the instrument prompts you to connect a through cable, connect the port 2 test cable to adapter A on port 1 as shown in [Figure 3-8](#). Press **Measure Standard** .

Figure 3-8 Through-Cable Connection

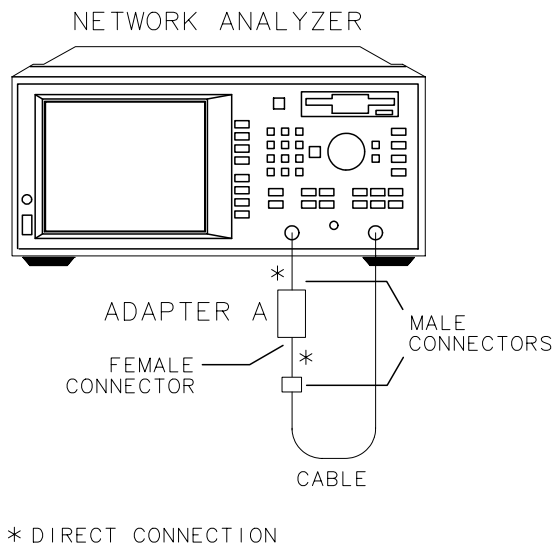

pp623es

Making Measurements
 Measuring S-Parameters using a Two-Port Calibration

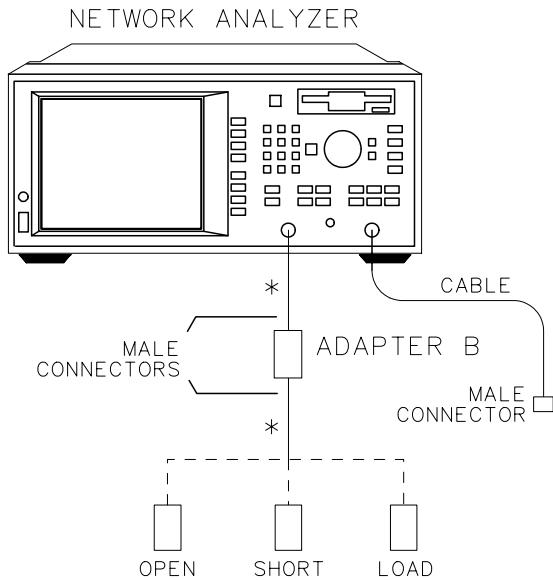

* DIRECT CONNECTION

pp624es

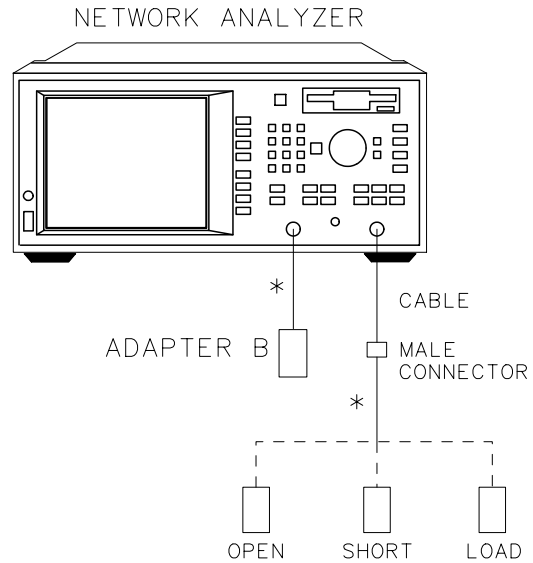

* DIRECT CONNECTION

pp633es

Port 1: Open, Short, Load Connections

Port 2: Open, Short, Load Connections

6. Remove adapter A, and place adapter B (type-N(m) to type-N(m)) on port 1. Adapter B becomes the effective test port.
7. When the instrument prompts you, connect three standards (open, short, and load) to adapter B—as shown in the above graphic.
8. Press **Measure Standard** after connecting each standard.
9. When the instrument prompts you, connect three standards (open, short, and load) to the port 2 cable—as shown in the above graphic.
10. Press **Measure Standard** after connecting each standard.
11. The analyzer will measure each standard and then calculate the new calibration coefficients. The message "Calibration complete." will appear for a few seconds when the analyzer is done calculating the new error correction array.

NOTE

Changing sweep frequencies (and other source parameters) may affect your calibration. See [Chapter 6](#) for more information.

Connect the DUT.

12. Measure the test device with adapter B in place as shown in [Figure 3-9](#).

Figure 3-9 **Equipment Setup for an S-Parameter Measurement of a Noninsertable Two-Port Device**

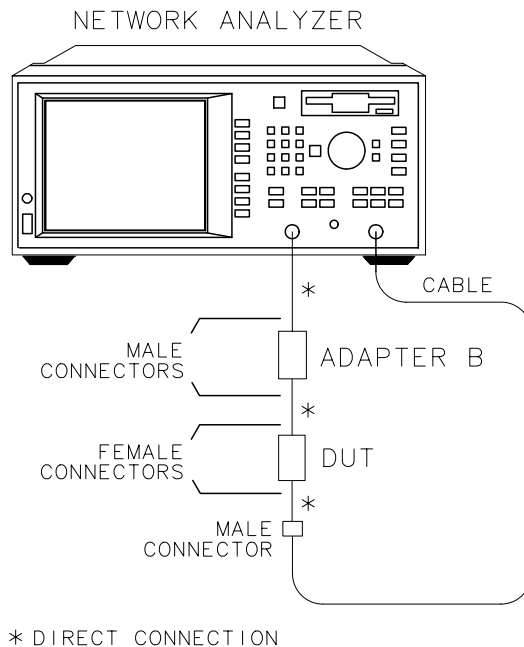

pp626es

Method B: Modify the Calibration Kit Definition of the Through Standard.

With this method, it is only necessary to use one adapter. The calibration kit through-standard definition is modified to compensate for the adapter and then saved as a user kit. However, the electrical delay of the adapter must first be found. Two examples of this method will be described: in example #1, the noninsertable device's input and output connectors are the same, and in example #2, the connectors are different.

NOTE

By convention, cal kit labels in the analyzer indicate the sex of the *port* with which they are used. For example, the default cal kit for the analyzer is type-N *female* because the front panel RF ports are female (the calibration standards, in turn, have male connectors).

EXAMPLE #1: the noninsertable device has type-N female input and output connectors.

NOTE

For analyzers with 50 ohm input impedance only: in the 50 ohm type-N calibration kit (85032B), there are four equal adapters: two APC-7-to-type-N(f), and two APC-7-to-type-N(m). To create the adapter in the following example, connect two APC-7-to-type-N(f) adapters.



1. Connect a test cable with type-N(m) connectors to the analyzer's port 1.
2. Connect a test cable with type-N(m) connectors to the analyzer's port 2.
3. To select a calibration kit for port 2, press **PRESET** (**User Preset** or **Factory Preset**) **CAL** **More Cal** **Cal Kit** , and use the front panel knob or the   keys to highlight Port 2 in the display's table. Press **Type-N(m)** .
4. Press **MEAS 1** **S22 Refl Port2** . Perform a one-port reflection calibration using type-N(f) standards on the type-N(m) open-end of the port 2 cable. Refer to [“Perform a User One-Port Calibration” on page 3-50](#).
5. Connect the type-N female-to-female adapter to the type-N(m) open-end of the port 2 cable.
6. Add a type-N(m) short to the open end of the adapter as shown in [Figure 3-10](#).

Figure 3-10 Port 2: Short Connection to the Adapter



* Direct Connection

px61e

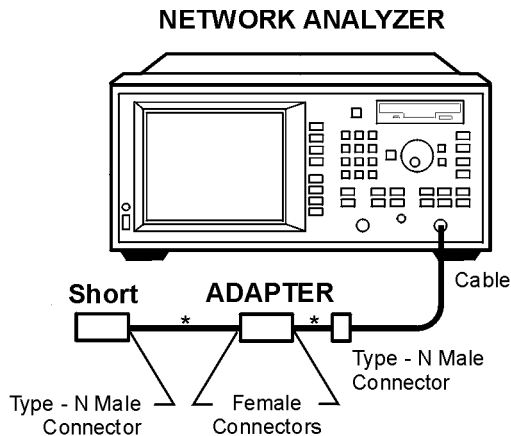

7. Select the delay format for your measurement by pressing **FORMAT Delay**.
8. Press **MARKER** to automatically select marker 1 as the active marker. Position marker 1 to the left edge of the measurement trace.
9. Press **2** to select marker 2 as the active marker. Position marker 2 to the right edge of the measurement trace.
10. Press **Marker Functions Marker Math Statistics**. Find the mean value, located in the upper right corner of the display.
11. Divide the mean value by 2. Record this value for use later in the procedure.
12. Select a type-N(f) calibration kit for port 2. This is necessary because the type-N(m) short (connected to the adapter on port 2) is a component in a type-N(f) calibration kit. Press **CAL More Cal Cal Kit**, and use the front panel knob or the **↑ ↓** keys to highlight Port 2 in the display's table. Press **Type-N(f)**.

13. Determine the offset delay of the calibration short:

- Press **SYSTEM OPTIONS** **Operating Parameters**
- Press **Next Screen** until the Cal Kit screen is displayed. In the “CAL KIT: Port 2,” display, find the numeric value for the delay of the short.

14. Subtract this value from the value calculated in [Step 11](#). This corresponds to the delay of the adapter.



15. Remove the short from the adapter.



16. Reselect a type-N(m) calibration kit for port 2. This is necessary because the type-N(m) short has been removed from the adapter. Press **CAL** **More Cal** **Cal Kit**, and use the front panel knob or the   keys to highlight Port 2 in the display's table. Press **Type-N(m)**.

17. Modify the calibration kit definition of the through-standard by entering the electrical delay of the adapter. To do so:

- Press **CAL** **More Cal** **Cal Kit** **Modify Type-N(m)** **Thru Delay**. Enter the delay value with the keypad and softkeys.

18. Save (and automatically assign) the modified cal kit buffer as a user-defined cal kit for port 2. To do so:

- Press **Prior Menu** **Mod Kit SaveRecall**. Use the front panel knob or the   keys to highlight the desired User Kit in the display's table. (In this example, highlight Cal Kit A.) Press **Save**.

If you want to enter a cal kit description in the display's table, press **Add Kit Description**. Use a keyboard connected to the analyzer's DIN KEYBOARD connector to enter the description. (If you don't have a keyboard, you can use the analyzer's   keys or the front panel knob and the **Select Char** key to select and enter characters from the top of the analyzer's display. Press **Enter** when done.)



19. Assign User Cal Kit A to port 1. (This User Cal Kit is assigned to both port 1 and port 2 since these ports are connected with the same adapter during the calibration.) To do so:
 - Press **Prior Menu** . Use the front panel knob or the   keys to highlight Port 1 in the display's table. Press **More Cal Kits** **User Cal Kit A** .
20. Start the calibration process by pressing **Prior Menu** until the Reflection Cal menu is displayed. Next, press **User 2-Port** **User 2-Port** . If you want to correct for crosstalk errors, toggle ON the **Isolation on OFF** key. (For more information about isolation, refer to the definition of a user two-port calibration in [Chapter 6](#).)
21. When the instrument prompts you to connect a through cable, insert the female-to-female adapter between the test cables connected to port 1 and port 2 as shown in [Figure 3-11](#). Press **Measure Standard** .

Figure 3-11 Through-Cable Connection



px62e

22. Remove the adapter between the test cables connected to port 1 and port 2.

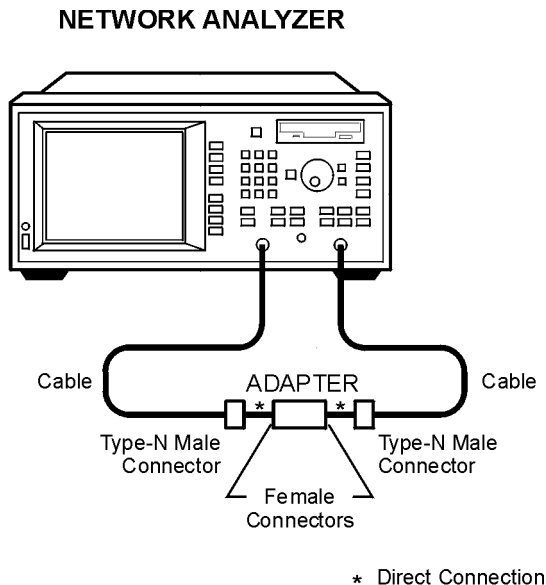
Making Measurements

Measuring S-Parameters using a Two-Port Calibration

23. When the instrument prompts you, connect three standards (open, short, and load) to the port 1 test cable as shown in the graphic on the following page.

24. Press **Measure Standard** after connecting each standard.

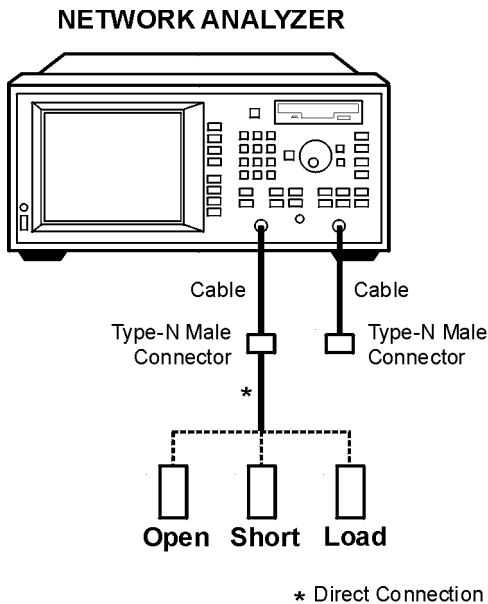

px63e

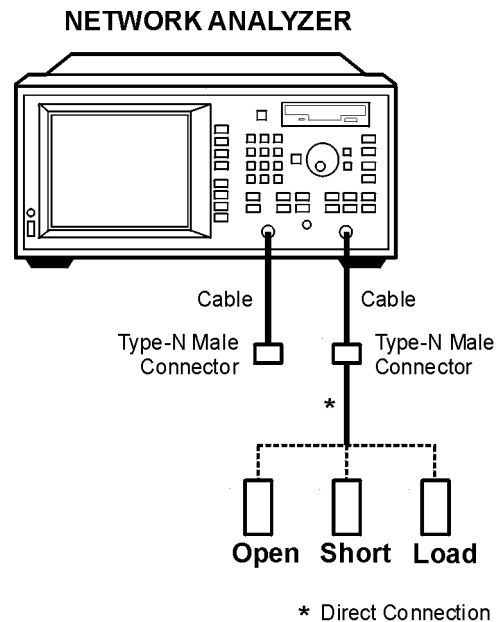

px64e

Port 1: Open, Short, Load Connections

Port 2: Open, Short, Load Connections

25. When the instrument prompts you, connect three standards (open, short, and load) to the port 2 test cable—as shown in the graphic above.

26. Press **Measure Standard** after connecting each standard.

27. The analyzer will measure each standard and then calculate new calibration coefficients. The message "Calibration complete." will appear for a few seconds when the analyzer is done calculating the new error correction array.

NOTE

Changing sweep frequencies (and other source parameters) may affect your calibration. See [Chapter 6](#) for more information.

Connect the DUT.

28. Measure the test device using the setup shown in [Figure 3-12](#).

Figure 3-12 **Equipment Setup for an S-Parameter Measurement of a Type-N(f) Two-Port Noninsertable Device**

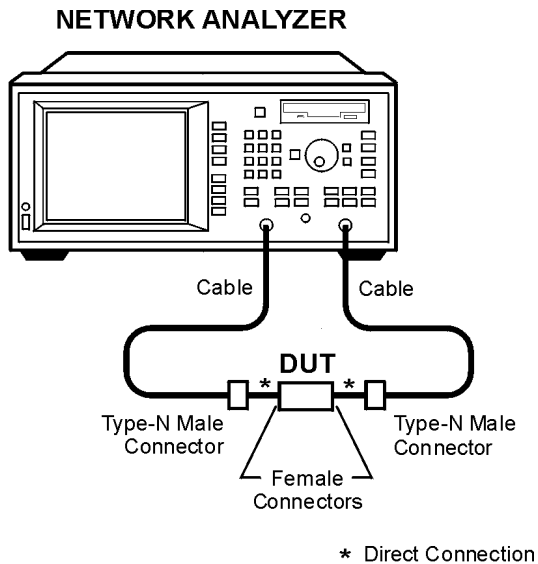

px65e

EXAMPLE #2: the noninsertable device has a 3.5 mm(f) input connector, and a type-N(f) output connector.

NOTE

For analyzers with 50 ohm input impedance only: in the 50 ohm type-N calibration kit (85032B), select the APC-7-to-type-N(f) adapter and in the 3.5 mm calibration kit (85033D), select the APC-7-to-3.5 mm(f) adapter. Connect these two adapters to create the type-N-to-3.5 mm female-to-female adapter in the following example.





1. Connect a test cable with 3.5 mm(m) connectors to the analyzer's port 1. (This example assumes a type-N(m)-to-3.5 mm(f) adapter is connected directly to the analyzer's port 1.)
2. Connect a test cable with type-N(m) connectors to the analyzer's port 2.
3. Press **PRESET** (**User Preset** or **Factory Preset**) **CAL** **More Cal** **Cal Kit** .
4. Select the proper calibration kits for each port:
 - For port 1, use the front panel knob or the   keys to highlight Port 1 in the display's table. Press **3.5 mm** .
 - For port 2, use the front panel knob or the   keys to highlight Port 2 in the display's table. Press **Type-N(m)** .
5. Press **MEAS 1** **S22 Refl Port2** . Perform a one-port reflection calibration using type-N(f) standards on the type-N(m) open-end of the port 2 test cable. Refer to [“Perform a User One-Port Calibration” on page 3-50.](#)
6. Connect the type-N-to-3.5 mm female-to-female adapter to the type-N(m) open-end of the port 2 test cable.
7. Add a 3.5 mm short to the open end of the adapter as shown in [Figure 3-13.](#)









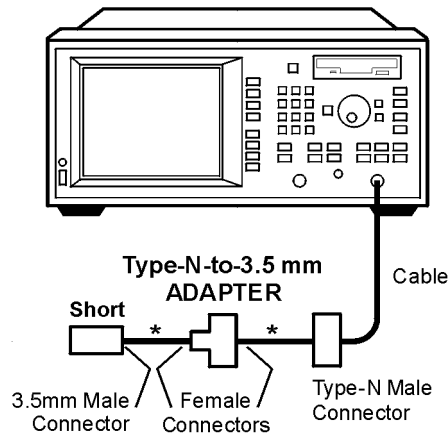

Figure 3-13 Port 2: Short Connection to the Adapter
NETWORK ANALYZER





* Direct Connection

px66e

8. Select the delay format for your measurement by pressing **FORMAT Delay**.
9. Press **MARKER** to automatically select marker 1 as the active marker. Position marker 1 to the left edge of the measurement trace.
10. Press **2** to select marker 2 as the active marker. Position marker 2 to the right edge of the measurement trace.
11. Press **Marker Functions Marker Math Statistics**. Find the mean value, located in the upper-right corner of the display.
12. Divide the mean value by 2. Record this value for use later in the procedure.
13. Determine the offset delay of the calibration short:
 - Press **SYSTEM OPTIONS Operating Parameters**.
 - Press **Next Screen** until the Cal Kit screen is displayed. In the "CAL KIT: Port 1," display, find the numeric value for the delay of the short. (This Port 1 heading is appropriate because the 3.5 mm short used in [Step 7](#) is from the calibration kit assigned to port 1.)

14. Subtract this value from the value calculated in [Step 12](#). This corresponds to the delay of the adapter.
15. Remove the short from the adapter.
16. Modify the Port 1 calibration kit definition of the through-standard by entering the electrical delay of the female-to-female adapter. To do so:
 - Press **CAL** **More Cal** **Cal Kit** and use the front panel knob or the   keys to highlight Port 1 in the display's table. Press **Modify 3.5 mm Thru Delay**. Enter the delay value with the keypad and softkeys.
17. Save (and automatically assign) the modified cal kit buffer as a user-defined cal kit for port 1. To do so:
 - Press **Prior Menu** **Mod Kit SaveRecall**. Use the front panel knob or the   keys to highlight the desired User Kit in the display's table. (In this example, highlight Cal Kit A.) Press **Save**.
 - If you want to enter a cal kit description in the display's table, press **Add Kit Description**. Use a keyboard connected to the analyzer's DIN KEYBOARD connector to enter the description. (If you don't have a keyboard, you can use the analyzer's   keys or the front panel knob and the **Select Char** key to select and enter characters from the top of the analyzer's display. Press **Enter** when done.)
18. Modify the Port 2 calibration kit definition of the through-standard by entering the electrical delay of the female-to-female adapter. To do so:
 - Press **CAL** **More Cal** **Cal Kit** and use the front panel knob or the   keys to highlight Port 2 in the display's table. Press **Modify Type-N(m) Thru Delay**. Enter the delay value with the keypad and softkeys.
19. Save (and automatically assign) the modified cal kit buffer as a user-defined cal kit for port 2. To do so:
 - Press **Prior Menu** **Mod Kit SaveRecall**. Use the front panel knob or the   keys to highlight the desired User Kit in the display's table. (In this example, highlight Cal Kit B.) Press **Save**.

If you want to enter a cal kit description in the display's table, press **Add Kit Description** . Use a keyboard connected to the analyzer's DIN KEYBOARD connector to enter the description. (If you don't have a keyboard, you can use the analyzer's   keys or the front panel knob and the **Select Char** key to select and enter characters from the top of the analyzer's display. Press **Enter** when done.)

20. Start the calibration process by pressing **Prior Menu** until the Reflection Cal menu is displayed. Next, press **User 2-Port** **User 2-Port** . If you want to correct for crosstalk errors, toggle ON the **Isolation on OFF** key (for more information about isolation, refer to the definition of a user two-port calibration in [Chapter 6](#)).
21. When the instrument prompts you to connect a through cable, insert the type-N-to-3.5 mm female-to-female adapter between the test cables connected to port 1 and port 2 as shown in [Figure 3-14](#). Press **Measure Standard** .

Figure 3-14 Through-Cable Connection

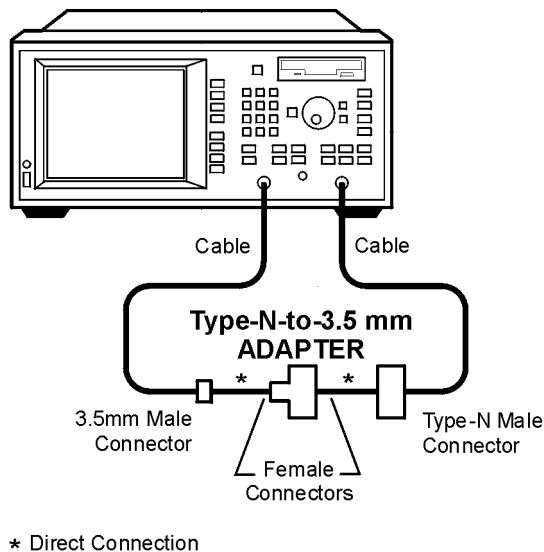

px67e

22. Remove the adapter between the test cables connected to port 1 and port 2.

Making Measurements

Measuring S-Parameters using a Two-Port Calibration

23. When the instrument prompts you, connect three 3.5 mm standards (open, short, and load) to the port 1 test cable as shown in the graphic on the following page.

24. Press **Measure Standard** after connecting each standard.

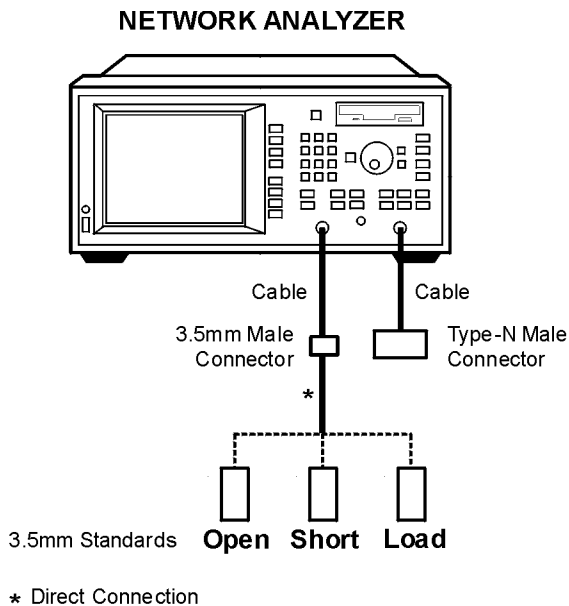

px68e

Port 1: Open, Short, Load Connections

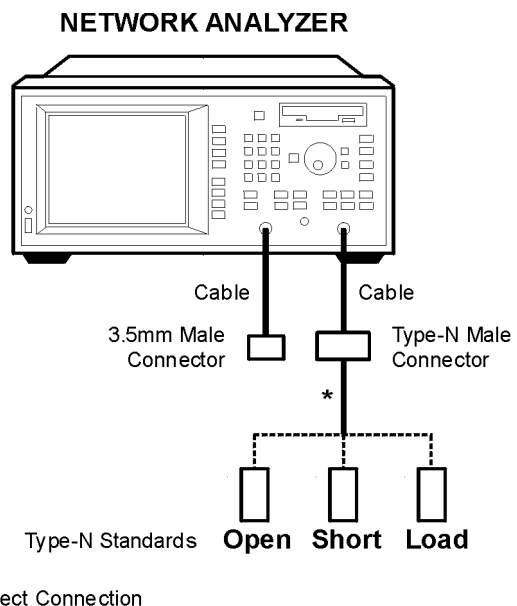

px69e

Port 2: Open, Short, Load Connections

25. When the instrument prompts you, connect three type-N standards (open, short, and load) to the port 2 test cable—as shown in the graphic above.

26. Press **Measure Standard** after connecting each standard.

27. The analyzer will measure each standard and then calculate new calibration coefficients. The message "Calibration complete." will appear for a few seconds when the analyzer is done calculating the new error correction array.

NOTE

Changing sweep frequencies (and other source parameters) may affect your calibration. See [Chapter 6](#) for more information.

Connect the DUT.

28. Measure the test device using the setup shown in [Figure 3-15](#).

Figure 3-15 Equipment Setup for an S-Parameter Measurement of a Type-N(f)-to-3.5 mm(f) Two-Port Noninsertable Device

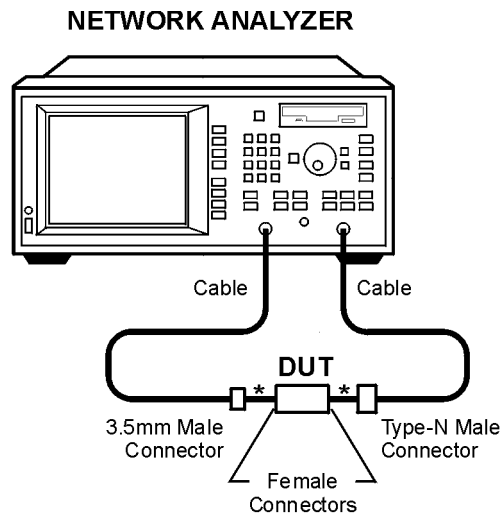

px610e

View and Interpret the S-Parameter Measurement Results

1. To view the entire measurement trace on the display, press **SCALE** **Autoscale**.
2. To interpret the measurement, refer to other S-parameter measurement examples later in this chapter.

Measuring S_{21} Forward Transmission using an Enhanced Response Calibration

This section uses an example measurement to describe how to calibrate for and make an S_{21} measurement. The same general concepts apply for an S_{12} measurement. This example uses an enhanced response calibration, but other calibration choices are also available. For example, a two-port calibration, explained earlier in this chapter, could be used for this measurement. Although the two-port calibration is the most accurate form of error correction, it results in a slower measurement speed than when using other calibrations. See the table below for a list of all possible calibration choices for S_{21} or S_{12} measurements.

TIP

An optimum calibration is critical for achieving best measurement accuracy. Refer to [Chapter 6, “Calibrating for Increased Measurement Accuracy,”](#) for detailed information about all of the various aspects of calibration.

Table 3-3**Calibration Choices for S_{21} and S_{12} Measurements**

Measurement Type	Calibration Choices
S_{21} Fwd Trans <i>or</i> S_{12} Rev Trans	Default Response Default 2-Port User Response: Response Response & Isolation Enhanced Response User 2-Port Normalize

In this example, an insertable bandpass filter like the one that was supplied with your network analyzer is used.

Enter the Measurement Parameters

Press **PRESET** (**User Preset** or **Factory Preset**) on the analyzer to set the analyzer to the default mode which includes measuring S₂₁ on measurement channel 1.

NOTE

This example measurement uses the default instrument parameters for an S₂₁ measurement. If your particular measurement requires different parameters (such as frequency range, source power level, number of data points, and sweptime), enter them now.

Perform an Enhanced Response Calibration

An enhanced response calibration uses known standards to correct for source match and frequency response errors when using narrowband detection. When you perform an enhanced transmission response calibration, the analyzer performs correction at each data point across the selected frequency band. The default number of data points per sweep is 201, but you can select any number between 3 and 1601. Interpolation recalculates the error correction array for reduced frequency spans. If the frequency span is increased, the calibration is invalidated, and the default response calibration is automatically restored.

To perform an enhanced transmission response calibration, you will need one of the following calibration kits depending on the nominal impedance of your analyzer:

Cal Kit Model Number	Impedance	Connector Type	For Use with Male Test Ports	For Use with Female Test Ports
85039B	75 Ω	type-F	✓	✓
85036B	75 Ω	type-N	✓	✓
85036E	75 Ω	type-N		✓
85032B	50 Ω	type-N	✓	✓
85032E	50 Ω	type-N		✓
85031B	50 Ω	APC-7	N/A	N/A
85033D	50 Ω	3.5 mm	✓	✓
85038A	50 Ω	7-16	✓	✓
85038F	50 Ω	7-16	✓	
85038M	50 Ω	7-16		✓

NOTE

By convention, cal kit labels in the analyzer indicate the sex of the *port* with which they are used. For example, the default cal kit for the analyzer is type-N *female* because the front panel RF ports are female (the calibration standards, in turn, have male connectors).

NOTE

If you are going to be using calibration standards other than the default (female type-N), you must select a calibration kit to match the port(s) at your calibration reference plane. Do this by pressing **CAL** **More Cal Cal Kit** and then selecting the appropriate type.

Calibrating for Insertable Devices

When doing a through-standard calibration, normally the test ports mate directly together. For example, two cables with the appropriate connectors can be connected directly without a through adapter, resulting in a zero-length through-standard. An insertable device is a device that can be inserted in place of a zero-length through-standard. It has the same type of connector on each port, but with a different sex, or the same type of sexless connector on each port (APC-7, for example).

[Chapter 6](#) provides detail about when a user-defined calibration is necessary, and information about other calibrations available for S₂₁ measurements. If you wish to perform an enhanced response calibration on your instrument for an S₂₁ measurement, execute the following steps:

1. Press **CAL** **User Response** **Enhanced Response** .
2. The instrument prompts you to connect four standards—open, short, load, and through cable—as shown in the following graphic.

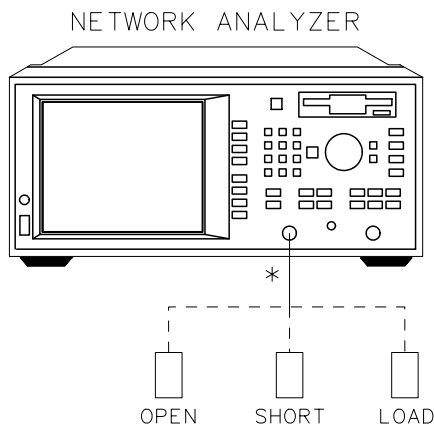

pp65es

* DIRECT CONNECTION

Open, Short, Load Connections

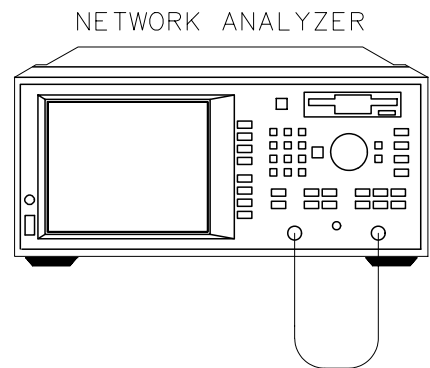

pp62es

Through Cable Connection

3. Press **Measure Standard** after connecting each standard.

4. The analyzer will measure each standard and then calculate the new calibration coefficients. The message "Calibration complete." will appear for a few seconds when the analyzer is done calculating the new error correction array.

NOTE

Changing sweep frequencies (and other source parameters) may affect your calibration. See [Chapter 6](#) for more information.

Calibrating for Noninsertable Devices

A non-insertable device is one that cannot be inserted in place of a zero-length through-standard. It has the same connectors on each port (type and sex) or has a different type of connector on each port (SMA on one port, and Type-N on the other, for example). To review two methods of calibration for non-insertable devices, refer to the previous section [“Measuring S-Parameters using a Two-Port Calibration” on page 3-20](#). In both methods, you will need to select **Enhanced Response** from the calibration menu instead of **User 2-Port**.

Connect the DUT

Figure 3-16

Equipment Setup for an S₂₁ Measurement

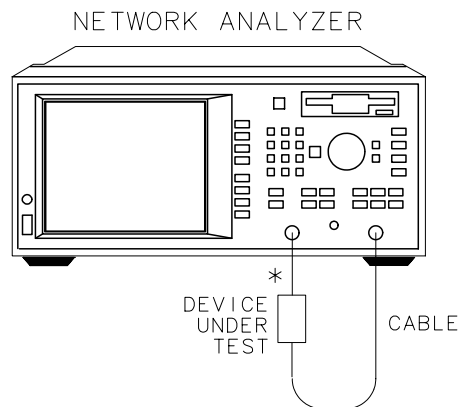

* DIRECT CONNECTION

pp64es

View and Interpret the S21 Measurement Results

1. To view the entire measurement trace on the display, press **SCALE** **Autoscale**.
2. To interpret the measurement, refer to [Figure 3-17, "Example of an S21 Measurement Display,"](#) or your analyzer's display if you are making this measurement on your instrument.
 - a. The values shown on the horizontal axis are the frequencies in MHz. The values shown on the vertical axis are the power ratios in decibels (dB) of the transmitted signal through the device divided by the incident power. To display the result in logarithmic magnitude format (designated by "Log Mag" at the top of the measurement screen), the analyzer computes the measurement trace using the following formula:

$$Transmission(dB) = 10 \log\left(\frac{P_{trans}}{P_{inc}}\right)$$

where P_{trans} = the power transmitted through the device and where P_{inc} = the incident power.

- b. A level of 0 dB would indicate a perfect through cable or device (no loss or gain). Values greater than 0 dB indicate that the DUT has gain. Values less than 0 dB indicate loss.
3. To quickly determine the filter's minimum insertion loss, press **MARKER** **Marker Search** **Max Search** **Mkr -> Max**.
4. Note the marker readout in [Figure 3-17](#) provides the frequency and amplitude of the minimum insertion-loss point.

Figure 3-17 Example of an S₂₁ Measurement Display

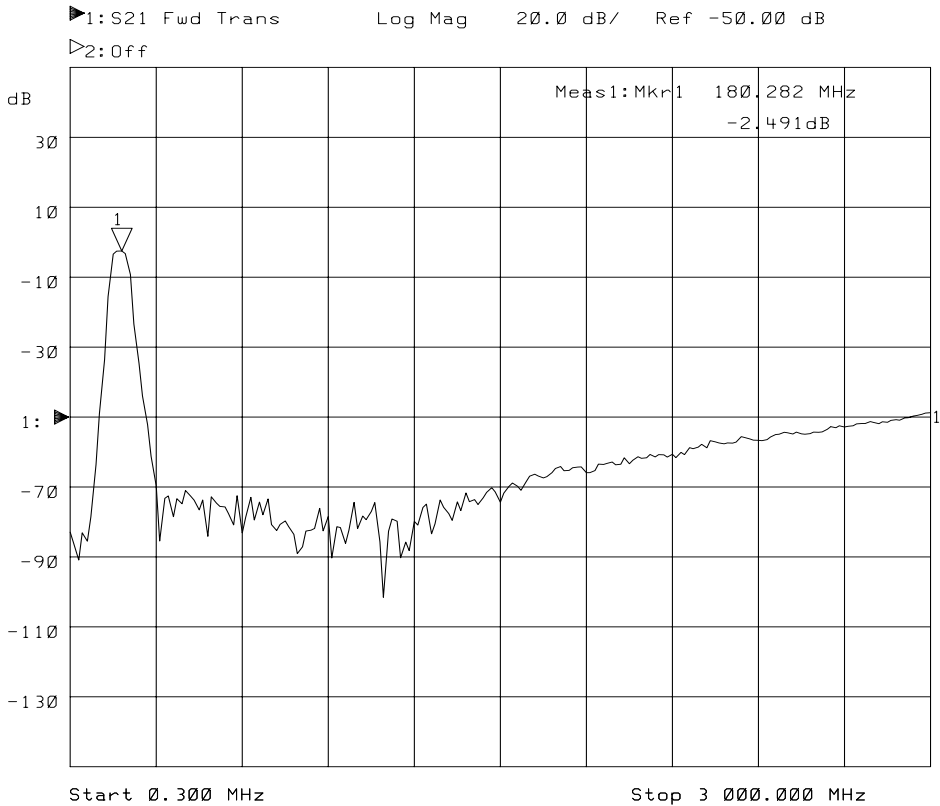

5. See “Using Markers” on page 4-3 in for more detailed information on using markers to interpret measurements.

NOTE

For the measurement to be valid, input signals must fall within the dynamic range of the analyzer. See Chapter 5, “Optimizing Measurements,” for techniques to increase the dynamic range of the analyzer.

Measuring S₁₁ Reflection Port 1 using a One-Port Calibration

This section uses an example measurement to describe how to calibrate for and make an S₁₁ measurement. The same general concepts apply for an S₂₂ measurement. This example uses a one-port reflection calibration, but a two-port calibration, explained earlier in this chapter, could also be used for this measurement. Although the two-port calibration is the most accurate form of error correction for a two-port device, it results in a slower measurement speed. See the table below for a list of all possible calibration choices for S₁₁ or S₂₂ measurements.

TIP

An optimum calibration is critical for achieving best measurement accuracy. Refer to [Chapter 6, “Calibrating for Increased Measurement Accuracy,”](#) for detailed information about all of the various aspects of calibration.

Table 3-4

Calibration Types for S₁₁ and S₂₂ Measurements

Measurement Type	Calibration Choices
S ₁₁ Refl Port 1 <i>or</i> S ₂₂ Refl Port 2	Default 1-Port Default 2-Port User 1-Port User 2-Port

In this example, a bandpass filter like the one that was supplied with your network analyzer is used.

Enter the Measurement Parameters

Press the following keys on the analyzer:

PRESET

(**User Preset** or **Factory Preset**)

MEAS 1

S11 Refl Port1

NOTE

This example measurement uses the default instrument parameters for an S_{11} measurement. If your particular reflection measurement requires different parameters (such as frequency range, source power level, number of data points, and sweep time), enter them now.

Perform a User One-Port Calibration

This example describes how to perform a one-port reflection calibration. A one-port reflection calibration uses known standards to correct for directivity, source match, and frequency response errors when using narrowband detection. When you perform a one-port reflection calibration, the analyzer performs correction at each data point across the selected frequency band. The default number of data points per sweep is 201, but you can select any number between 3 and 1601. Interpolation recalculates the error correction array for reduced frequency spans. If the frequency span is increased the calibration is invalidated, and the default one-port calibration is automatically restored.

To perform a one-port calibration you will need one of the following calibration kits depending on the nominal impedance of your analyzer:

Cal Kit Model Number	Impedance	Connector Type	For Use with Male Test Ports	For Use with Female Test Ports
85039B	75 Ω	type-F	✓	✓
85036B	75 Ω	type-N	✓	✓
85036E	75 Ω	type-N		✓
85032B	50 Ω	type-N	✓	✓
85032E	50 Ω	type-N		✓
85031B	50 Ω	APC-7	N/A	N/A
85033D	50 Ω	3.5 mm	✓	✓
85038A	50 Ω	7-16	✓	✓
85038F	50 Ω	7-16	✓	
85038M	50 Ω	7-16		✓

NOTE

By convention, cal kit labels in the analyzer indicate the sex of the *port* with which they are used. For example, the default cal kit for the analyzer is type-N *female* because the front panel RF ports are female (the calibration standards, in turn, have male connectors).

NOTE

If you are going to be using calibration standards other than the default (female type-N), you must select a calibration kit to match the port(s) at your calibration reference plane. Do this by pressing **CAL** **More Cal** **Cal Kit** and then selecting the appropriate type.

Chapter 6 provides detail about when this calibration is necessary, and information about other calibrations available for S_{11} measurements. If you wish to perform a one-port reflection calibration on your instrument for an S_{11} measurement, execute the following steps:

1. Press **CAL** **User 1-Port**.
2. The instrument will prompt you to connect three standards (open, short and load) to port 1. See Figure 3-18

Figure 3-18 Open, Short, Load Connections

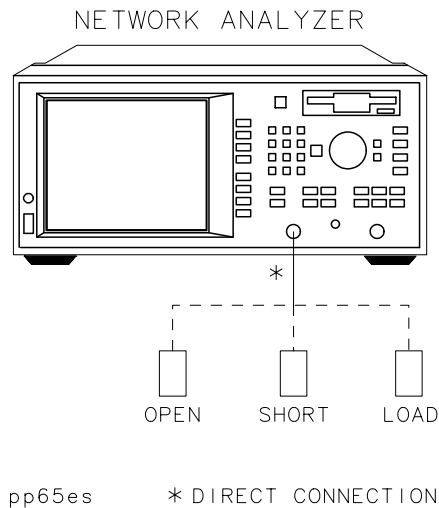

3. Press **Measure Standard** after connecting each standard.
4. The analyzer will measure each standard and then calculate new calibration coefficients. The message "Calibration complete." will appear for a few seconds when the analyzer is done calculating the new error correction array.

NOTE

Changing sweep frequencies (and other source parameters) may affect your calibration. See Chapter 6 for more information.

Connect the DUT

Figure 3-19 Equipment Setup for an S_{11} Measurement of a Two-Port Device

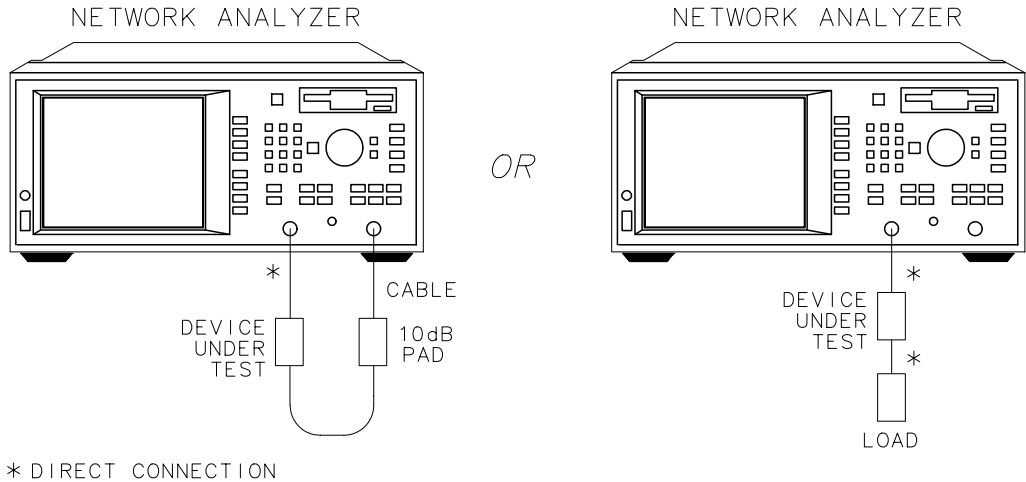

pp66es

NOTE

If you connect the DUT between both analyzer ports, it is recommended that you use a 10 dB pad on the output of the DUT to improve measurement accuracy. If you connect a two-port DUT to only one analyzer port, it is recommended that you use a high-quality load (such as a calibration standard) on the output of the DUT.

Figure 3-20

Equipment Setup for an S_{11} Measurement of a One-Port Device

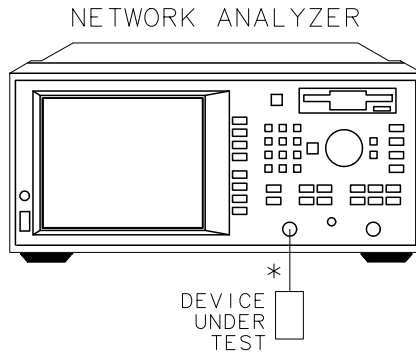

* DIRECT CONNECTION

pp67es

View and Interpret the S11 Measurement Results

1. To view the entire measurement trace on the display, press **SCALE** **Autoscale** .
2. To interpret the reflection measurement, refer to [Figure 3-21](#), “[Example of an S11 Measurement Display](#),” or your analyzer's display if you are making this measurement on your instrument.
 - a. The values shown on the horizontal axis are the frequencies in MHz. The values shown on the vertical axis are the power ratios in decibels (dB) of the reflected signal divided by the incident power. To display the result in logarithmic magnitude format (designated by Log Mag at the top of the measurement screen), the analyzer computes the measurement trace using the following formula:



$$Reflection(dB) = 10 \log\left(\frac{P_{refl}}{P_{inc}}\right)$$

where P_{refl} = the power of the signal reflected from the device and where P_{inc} = the incident power.

- b. A level of 0 dB indicates that all of the power applied to the DUT is reflected back, and that none of it passes through the DUT or is absorbed by the DUT.
- c. Values less than 0 dB indicate that power is either absorbed or transmitted by the DUT. Although not commonly seen, values greater than 0 dB can occur under certain circumstances such as when the measurement needs to be enhanced by calibration, or when the device is active (an amplifier for instance) and perhaps oscillating.

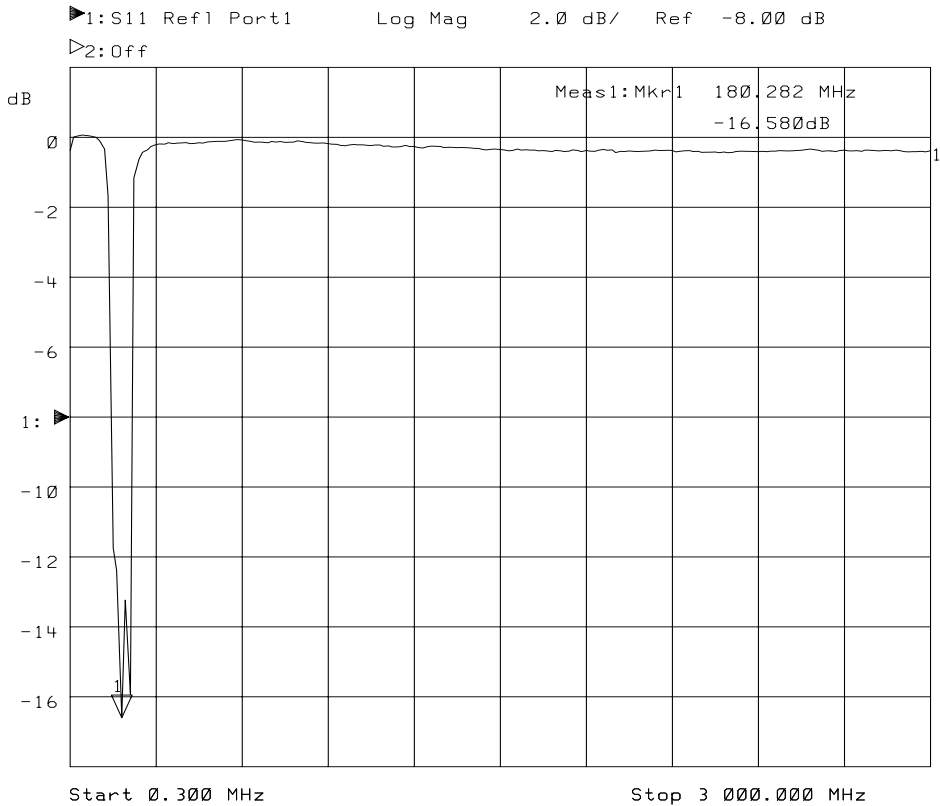
Figure 3-21 Example of an S₁₁ Measurement Display



3. To quickly determine the filter's return loss, press **MARKER** and then use the front panel knob, the   keys, or the numeric keypad to read the value of return loss at the desired frequency.
4. See [“Using Markers” on page 4-3](#) in for detailed information on using markers to interpret measurements.

Making a Power Measurement using Broadband Detection

Power measurements can be made using either narrowband or broadband detection. The example in this section is of a broadband power measurement. If you are only interested in the output power of your device at the same frequency as the analyzer's source, you can select **(MEAS 1) Detection Options Narrowband Internal B** for a narrowband detection power measurement. A narrowband detection power measurement only measures the power within the tuned receiver's bandwidth, centered at the source frequency.

When you measure a device for absolute output power, the network analyzer uses the broadband detection mode and measures the total power of all frequencies present in the transmitted signal (B*). This signal may contain frequencies other than the source frequency such as when the DUT is a mixer.

This section uses an example measurement to describe how to normalize the data and measure the total output power of an amplifier.

NOTE

Broadband power measurements are only specified for measurements with a start frequency of ≥ 10 MHz.

Enter the Measurement Parameters

Press the following keys on the analyzer:

(PRESET)

(User Preset or Factory Preset)

(MEAS 1)

More Power

NOTE

This example measurement uses the default instrument parameters for a power measurement. If your particular power measurement requires different parameters (such as source power level, number of data points, and sweep time), enter them now.

CAUTION

Damage to your analyzer will occur if the receiver input power exceeds +26 dBm or ± 30 Vdc. The analyzer's source cannot exceed this level. However, if your DUT has gain, attenuation on the analyzer's input port may be necessary. See [“Attenuation and Amplification in a Measurement Setup”](#) on page 3-12.

Perform a Normalization Calibration

Normalization is the simplest type of calibration. The analyzer stores a measurement trace into memory and divides subsequent measurements by the stored data to remove unwanted frequency response errors. This calibration is used for the power measurement to remove the insertion-loss error of the test cable. Changing the frequency span or number of measurement points will invalidate a normalization calibration.

Execute the following steps to perform a normalization calibration:

1. Connect the equipment as shown in [Figure 3-22](#)

Figure 3-22 Through-Cable Connection

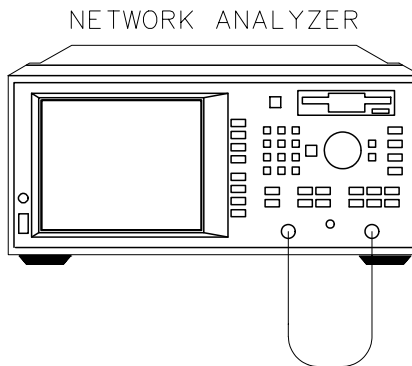

pp62es

2. Set the following frequency parameters:

FREQ

Start **10** **MHz**

3. Press **DISPLAY** **Normalize** or **CAL** **Normalize on OFF**.

This stores the data into memory and divides subsequent measurements by the stored data to remove frequency response errors.

4. Insert the amplifier as shown in [Figure 3-23](#).

Connect the DUT

Figure 3-23

Equipment Setup for a Power Measurement

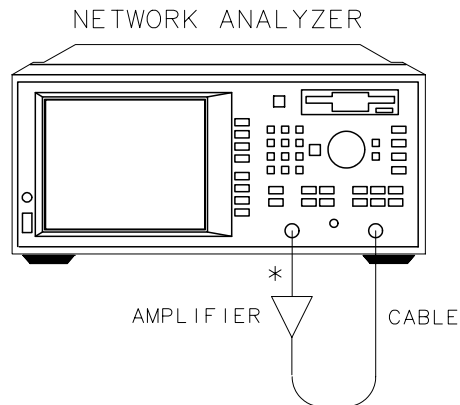

* DIRECT CONNECTION

pp629es

View and Interpret the Power Measurement Results

1. To view the measurement trace, press **SCALE** **Autoscale** .
2. To interpret the power measurement, refer to [Figure 3-24](#) or your analyzer's display if you are making this measurement on your instrument.
 - a. When making a power measurement, the display shows the power measured at the analyzer's input connector. This power is absolute power, as opposed to a power ratio.
 - b. Note that when making a power measurement, the values associated with the vertical axis are in units of dBm, which is the power measured in reference to 1 mW.
 - 0 dBm = 1 mW
 - -10 dBm = 100 μ W
 - +10 dBm = 10 mW

Other units available for a power measurement include dBW, dB μ W, W, mW and μ W.

Figure 3-24 Example of a Power Measurement

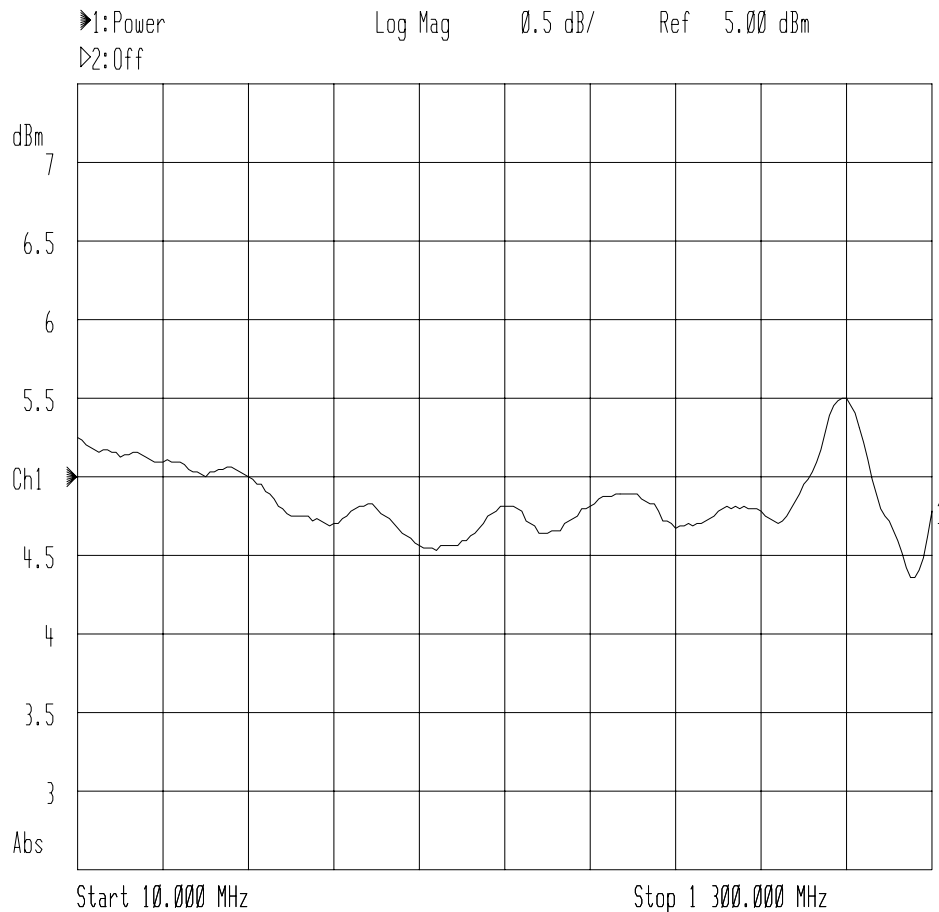

CAUTION

If the analyzer's RF output power level is set to higher than the specified output power for your analyzer, the source could go unlevelled. See [Chapter 9, "Specifications,"](#) for source and receiver specifications. If your device requires input power greater than your analyzer's specified output power, you may need to use a preamplifier in your measurement setup. However, remember to not exceed the receiver damage limit of +26 dBm.

Measuring Conversion Loss

Conversion loss is the ratio of IF output power to RF input power expressed in dB. This section uses an example measurement to describe how to measure the conversion loss of a broadband mixer.

When characterizing a device's conversion loss, the analyzer uses broadband detection to compare the transmitted signal (B^*) to the reference signal (R^*). This is because the input and output signals of a frequency-translating device may be different. Since broadband detection measures signals at all frequencies, you may want to use a filter to remove unwanted signals such as LO feedthrough when performing this measurement.

For example, an RF signal at 900 MHz mixed with an LO signal at 200 MHz, results in mixing products at 700 MHz and 1100 MHz, as well as the original 900 MHz RF and 200 MHz RF and LO signals.

Figure 3-25 Filtering Out the Unwanted Mixing Product

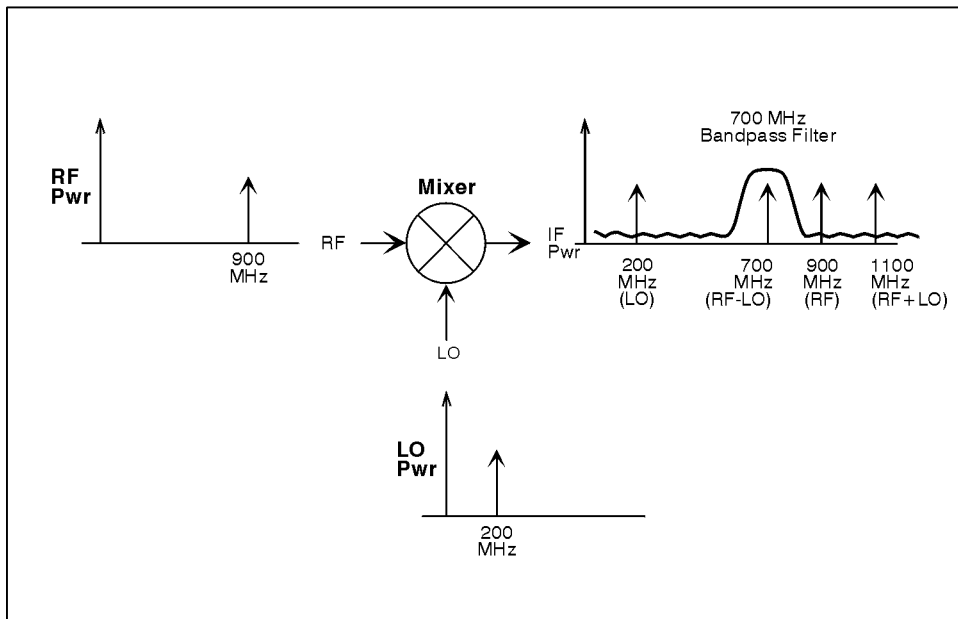

po650b_c

Inserting a 700 MHz bandpass filter in the measurement setup removes the unwanted signals at 200 MHz, 900 MHz, and 1100 MHz, providing an accurate measurement of the desired IF signal at 700 MHz.

In the following example, the conversion loss of a mixer will be measured with RF input frequencies over a 15 MHz span centered at 900 MHz. With an LO frequency of 200 MHz, the mixer IF frequency will sweep over a 15 MHz span centered at 700 MHz.

Enter the Measurement Parameters

Press the following keys on the analyzer:

PRESET (**User Preset** or **Factory Preset**)

MEAS 1

More **Conversion Loss**

NOTE

This example measurement uses the default instrument parameters for a conversion loss measurement. If your particular conversion loss measurement requires different parameters (such as source power level, number of data points, and sweptime), enter them now.

Perform a Normalization Calibration

Normalization is the simplest type of calibration. The analyzer stores a measurement trace into memory and divides subsequent measurements by the stored data to remove unwanted frequency-response errors. This calibration is used for this measurement to remove the insertion loss errors of the IF filter and the interconnect cables. Changing the frequency span or number of measurement points will invalidate a normalization calibration.

Perform the following steps to perform a normalization calibration:

1. Connect the equipment as shown in [Figure 3-26](#).

Figure 3-26 Through-Cable Connection

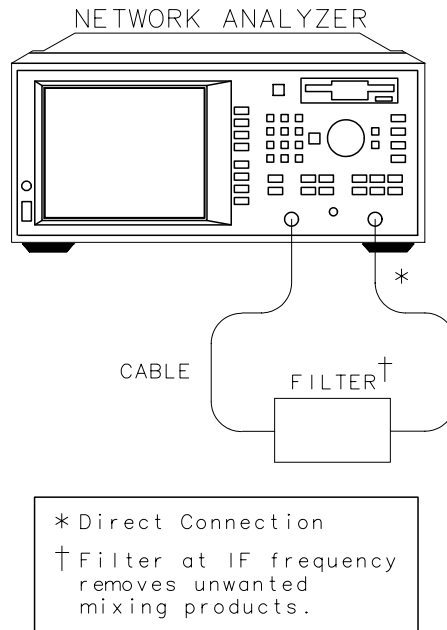

2. Set the following frequency parameters:

FREQ

Center **700** **MHz**

Span **15** **MHz**

This sets the analyzer frequency range to sweep over the passband of the IF filter (700 MHz).

3. Press **DISPLAY** **Normalize** or **CAL** **Normalize on OFF**.

This stores the filter response passband into memory, and sets up a normalized trace so that the filter response magnitude is removed from the measurement.

4. Insert the mixer as shown in [Figure 3-27](#).
5. Press **FREQ** **Center** **900** **MHz** to change the center frequency so that the mixing product of the mixer is in the passband of the IF filter.

Connect the DUT

Figure 3-27 Equipment Setup for a Conversion Loss Measurement

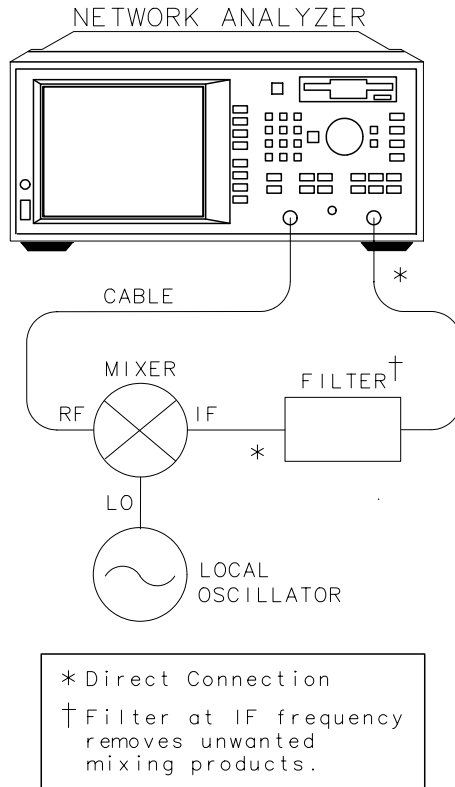

pp68es

View and Interpret the Conversion Loss Results

1. If necessary to view the measurement trace, press **SCALE** **Autoscale** .
2. To interpret the conversion loss measurement, refer to [Figure 3-28](#), “[Example of a Conversion Loss Measurement](#),” or your analyzer's display if you are making this measurement on your instrument.
 - a. The values shown on the horizontal axis represent the source RF output. The values shown on the vertical axis are the power ratio in decibels (dB) of the transmitted signal through the device divided by the incident power. To display the result in logarithmic magnitude format (designated by Log Mag at the top of the measurement screen), the analyzer computes the measurement trace using the following formula:

$$\text{Conversion Loss}(dB) = 10 \log\left(\frac{P_{trans}}{P_{inc}}\right)$$

where P_{trans} = the power measured at the IF output of the mixer and where P_{inc} = the incident power at the RF input.

- b. A level of 0 dB would indicate a perfect device (no loss or gain). Values greater than 0 dB indicate that the mixer has gain. Values less than 0 dB indicate mixer conversion loss.
3. If you wish, you can quickly determine the mixer's minimum conversion loss by pressing **MARKER** **Marker Search** **Max Search** **Mkr** **->** **Max** .

Figure 3-28 Example of a Conversion Loss Measurement

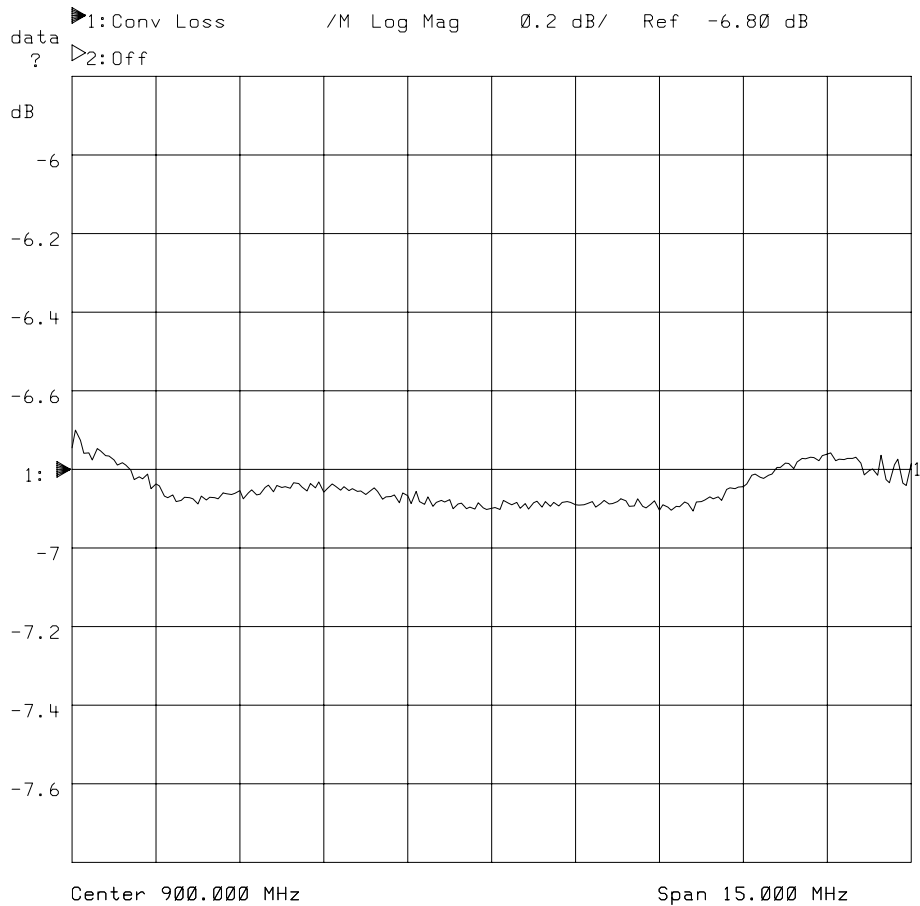

NOTE

For the measurement to be valid, input signals must fall within the dynamic range and frequency range of the analyzer. See [Chapter 5](#) for techniques to increase the dynamic range of the analyzer.

Making Measurements with the Auxiliary Input

The auxiliary input (AUX INPUT) is located on the rear panel of your analyzer. See [Figure 7-2, “Analyzer Connectors—Rear Panel BNC Connectors,”](#) on [page 7-4](#). This input is designed to monitor sweep-related dc control signals of devices generally used in conjunction with the analyzer, such as a dc-biased amplifier, or a voltage controlled oscillator (VCO).

The AUX INPUT is *not* recommended for use as an oscilloscope, for several reasons. This input is sampled only once per data point regardless of sweep speed, bandwidth, or number of points per sweep, and sampled data points may not occur at evenly spaced intervals unless the analyzer is in CW mode.

The AUX INPUT sampling rate depends upon the instrument state and sweep. In CW mode with the fastest possible sweep time (**Sweep Time** set to AUTO), system bandwidth has the most significant effect on this timing. Data points are typically taken at about 0.2, 0.6, 7.2, and 70 ms intervals in wide, medium, narrow, and fine bandwidths, respectively. This effect must be taken into account if attempting to view signals that are unrelated to the sweep ramp. For best accuracy, input signal slew rate should be less than 700 volts per second.

Even though the AUX INPUT is not recommended for use as an oscilloscope, it is possible to view sine wave signals up to about 400 Hz with reasonable accuracy by placing the analyzer in CW mode with wide system bandwidth.

Auxiliary Input Characteristics

Nominal impedance	10 k Ω
Accuracy	\pm (3% of the auxiliary input reading + 20 mV)
Calibrated range	\pm 10 V
Usable range	\pm 15 V
Maximum input	\pm 15 V
Damage Level	\pm 15.1 V

Measuring Group Delay

The phase linearity of many devices is specified in terms of group delay. This is especially true of telecommunications components and systems where phase distortion is critical.

Group delay is a measure of transit time through the DUT as a function of frequency. It is approximated by:

$$\frac{-\Delta\phi}{(\Delta f)(360)}$$

where $\Delta\phi$ is the phase difference between two adjacent frequencies Δf . The quantity Δf is commonly referred to as the aperture. The minimum aperture is equal to the analyzer's frequency span divided by the number of points minus one, and can be entered as a frequency or a percent of span. To measure group delay correctly, the phase difference at a specific aperture must be less than 180 degrees, satisfying the following relationship:

$$\text{frequency span} < \frac{\text{number of points} - 1}{2(\text{approx. DUT delay})}$$

If this relationship is not satisfied, incorrect measurements will occur since the measurement of the phase difference at adjacent points will be undersampled.

This section uses an example measurement to describe how to calibrate for and make a basic phase-derived delay (group delay) measurement. An S_{21} measurement is demonstrated in this example, but the same general concepts apply for an S_{12} measurement. This example uses a two-port calibration, but other calibration choices are also available. For example, a response calibration could be used for this measurement. Though not quite as accurate as two-port error correction, a response calibration offers the advantage of faster measurement speeds than when using a two-port calibration. In this example, an insertable bandpass filter like the one that was supplied with your network analyzer is used.

TIP

An optimum calibration is critical for achieving best measurement accuracy. Refer to [Chapter 6, “Calibrating for Increased Measurement Accuracy,”](#) for detailed information about all of the various aspects of calibration.

NOTE

Phase-derived delay cannot be used to measure frequency-translating devices.

Enter the Measurement Parameters

1. Press the following keys on the analyzer:

PRESET

(**User Preset** or **Factory Preset**)

MEAS 1

S21 Fwd Trans

FORMAT

Delay

FREQ **Center** **175** **MHz**

Span **200** **MHz**

2. Choose an aperture. When choosing an aperture, there is a trade-off between minimum apertures (giving more resolution but noisier responses) and maximum apertures (giving less resolution but smoother responses). For this example, choose an aperture of 4% by pressing:

AVG

Delay Aperture

Aperture (%)

4 **Enter**

Perform a User Two-Port Calibration

Refer to the section “[Measuring S-Parameters using a Two-Port Calibration](#)” on page 3-20 for examples of how to perform a user two-port calibration.

Connect the DUT

Figure 3-29 Equipment Setup for a Group Delay Measurement

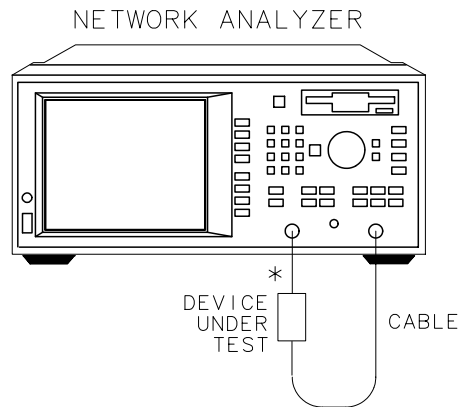

* DIRECT CONNECTION

pp64es

View and Interpret the Group Delay Measurement Results

1. To view the entire measurement trace on the display, press **SCALE** **Autoscale**.
2. To interpret the group delay measurement, refer to [Figure 3-30](#), “[Example of a Phase-Derived Delay Measurement Display](#),” or your analyzer's display if you are making this measurement on your instrument.
 - a. The measurement trace depicts the amount of time it takes for each frequency to travel through the DUT.

- To quickly determine the filter's maximum delay point, press **MARKER** **Marker Search** **Max Search** **Mkr -> Max**.
- Note the marker readout in [Figure 3-30](#) provides the frequency and delay (in nanoseconds) of the maximum delay point.

Figure 3-30 Example of a Phase-Derived Delay Measurement Display

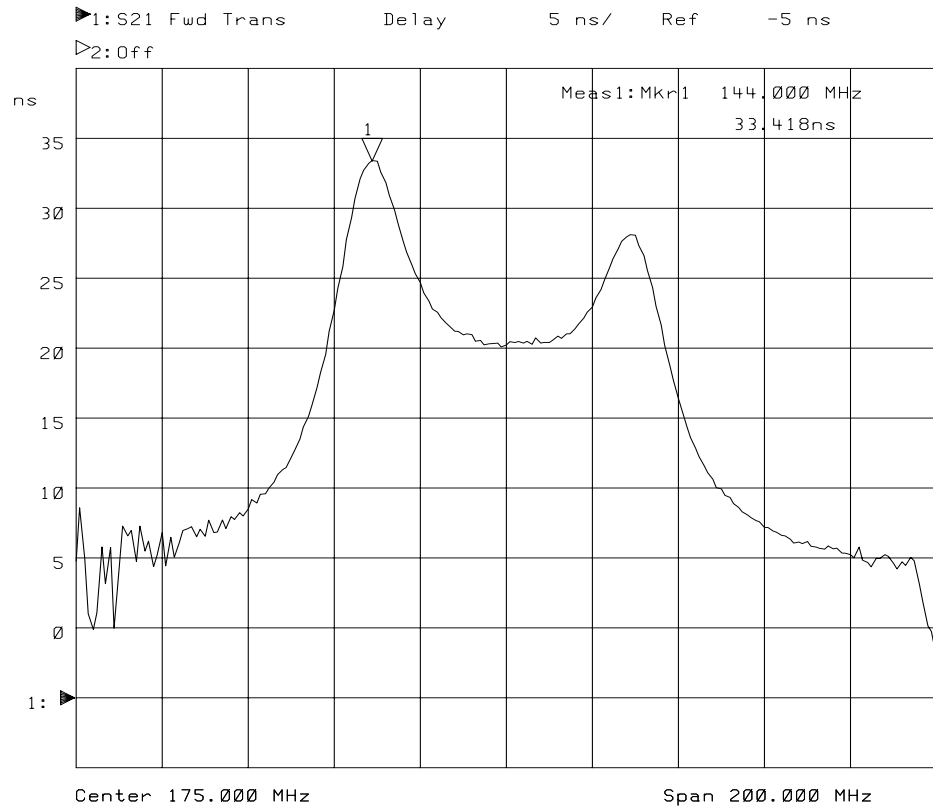

- See [“Using Markers” on page 4-3](#) for more detailed information on using markers to interpret measurements.

NOTE

Phase-derived delay measurements can benefit from the noise reduction techniques discussed in [Chapter 5](#).

Measuring Impedance using the Smith Chart

The amount of power reflected from a device is directly related to the impedances of both the device and the measuring system; for example, the value of the complex reflection coefficient Γ is equal to 0 only when the device impedance and the system impedance are exactly the same. Each value of Γ uniquely defines a device impedance.

The Smith chart is a tool used to map the complex reflection coefficient Γ to the DUT's impedance. In a Smith chart, the complex impedance plane is reshaped to form a circular grid, from which the series resistance and reactance can be read ($R + jX$). (See [Figure 3-33, “Interpreting the Smith Chart,”](#) for more information on the Smith chart.) Marker features on the analyzer display the resistance in units of ohms, and the reactance as an equivalent capacitance or inductance in units of farads or henrys.

This section uses an example measurement to describe how to measure the input impedance of an insertable bandpass filter like the one that was supplied with your network analyzer. An S_{11} measurement is demonstrated in this example, but the same general concepts apply for an S_{22} measurement.

TIP

An optimum calibration is critical for achieving best measurement accuracy. Refer to [Chapter 6, “Calibrating for Increased Measurement Accuracy,”](#) for detailed information about all of the various aspects of calibration.

Enter the Measurement Parameters

Press the following keys on the analyzer:

PRESET

(User Preset or Factory Preset)

MEAS 1

S11 Refl Port1

FREQ Center 175 MHz

Span 200 MHz

NOTE

This example measurement uses the default instrument parameters for an S_{11} measurement. If your particular measurement requires different parameters (such as frequency range, source power level, number of data points, and sweep time) enter them now.

Perform a User Two-Port Calibration

Refer to the section [“Measuring S-Parameters using a Two-Port Calibration” on page 3-20](#) for examples of how to perform a user two-port calibration.

NOTE

If you are testing a one-port device, refer to the section [“Perform a User One-Port Calibration” on page 3-50](#) for an example of how to perform a one-port calibration.

Connect the DUT

Figure 3-31 Equipment Setup for an S_{11} Measurement of a Two-Port Device

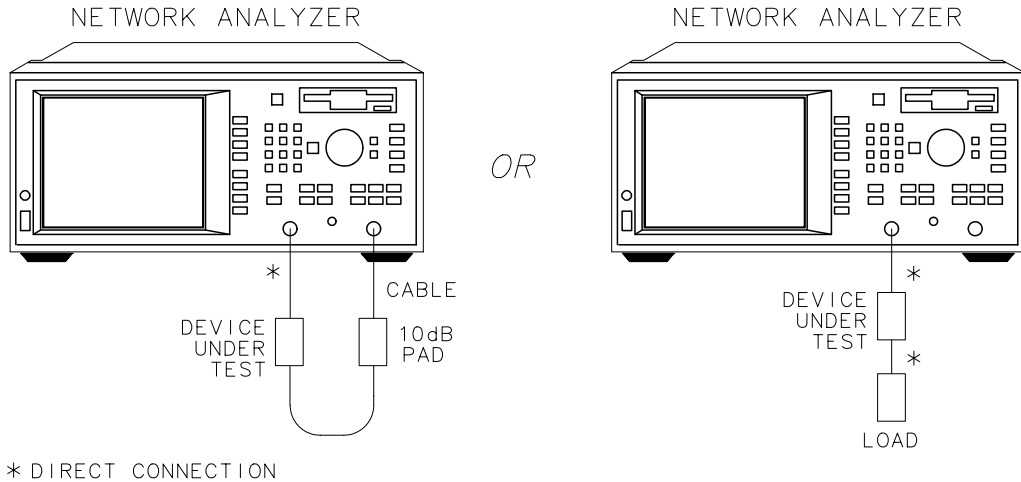

pp66es

NOTE

If you connect the DUT between both analyzer ports, it is recommended that you use a 10 dB pad on the output of the DUT to improve measurement accuracy. If you connect a two-port DUT to only one analyzer port, it is recommended that you use a high-quality load (such as a calibration standard) on the output of the DUT.

Figure 3-32 Equipment Setup for an S_{11} Measurement of a One-Port Device

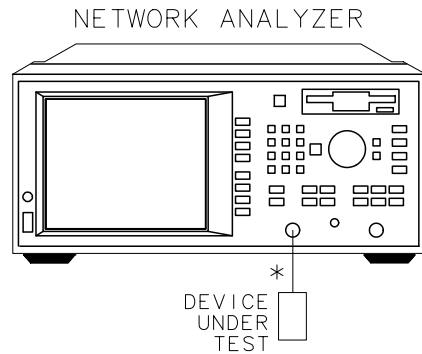

pp67es

View and Interpret the Impedance Measurement Results

1. Press **FORMAT** **Smith Chart**.
2. To interpret the impedance measurement, refer to [Figure 3-33](#) for the following discussion:
 - a. The horizontal axis (the solid line) is the real portion of the impedance—the resistance. The center of the horizontal axis always represents the system impedance ($50\ \Omega$ in this example).
 - b. The dashed circles that intersect the horizontal axis represent constant resistance. The dashed arcs that are tangent to the horizontal axis represent constant reactance.
 - c. The upper half of the Smith chart is the area where the reactive component is positive and therefore inductive. The lower half is the area where the reactive component is negative and therefore capacitive.

Figure 3-33 Interpreting the Smith Chart

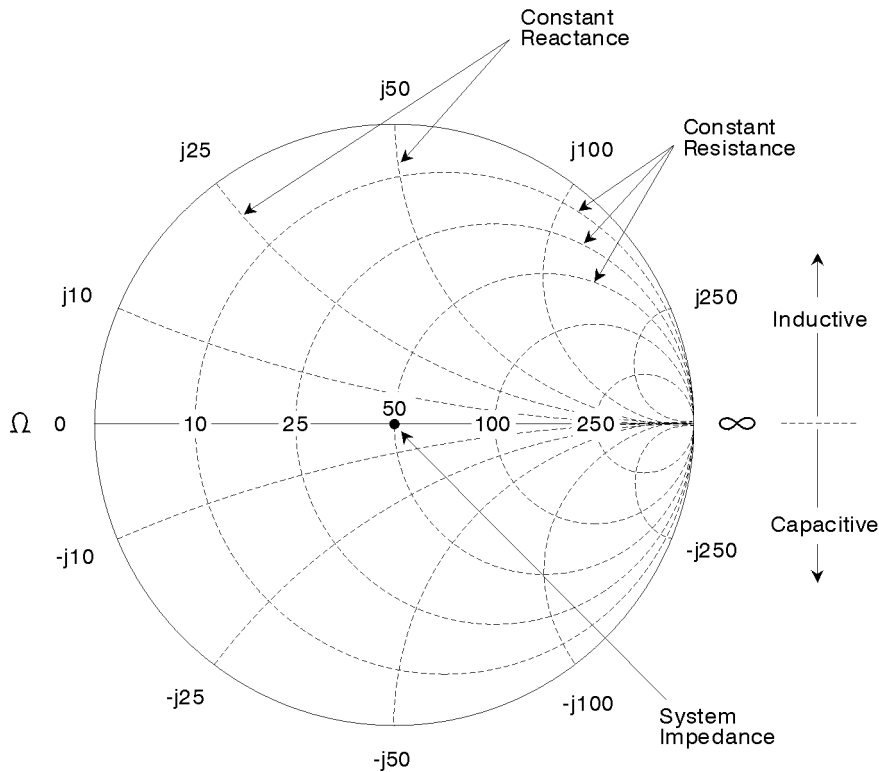

po645b_c

d. The magnitude and phase of the reflection coefficient, Γ , can be determined in the following two ways.

i. Reading the Smith chart as follows:

- $\rho = |\Gamma|$ = the distance from the measurement point to the center point on the chart. See [Figure 3-34, “Determining the Magnitude and Phase of the Reflection Coefficient.”](#)
- $\angle \Gamma = \theta$ = the angle between the horizontal axis of the Smith chart and a line from the center point to the measurement point. See [Figure 3-34.](#)

- ii. Displaying the measurement in polar format and using the marker readout of magnitude and phase. To do so, press **FORMAT Polar**.

Figure 3-34 Determining the Magnitude and Phase of the Reflection Coefficient

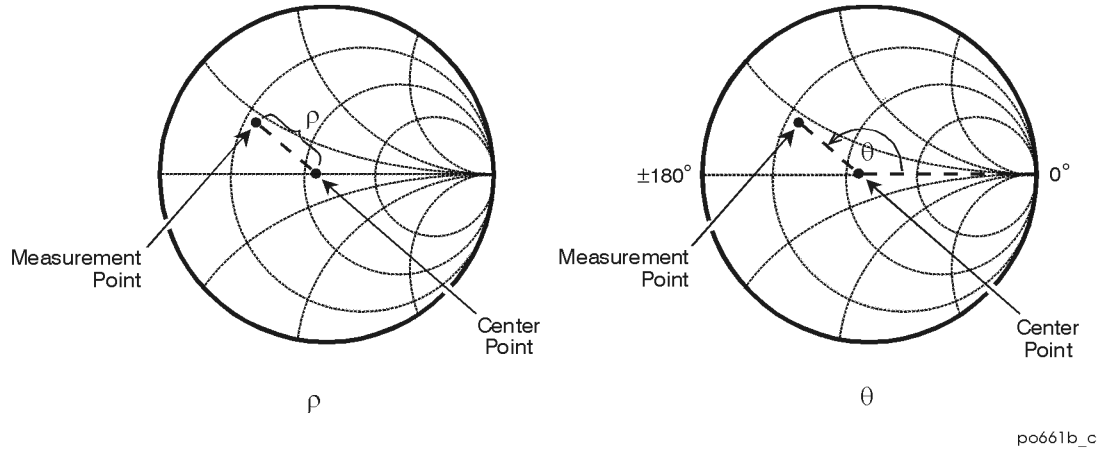

3. **Figure 3-35** shows an example of an actual measurement. Note the marker readout in the upper right corner of the display. The marker values are frequency, resistance, reactance, and the equivalent capacitance or inductance, respectively.

Figure 3-35 Example of an Impedance Measurement

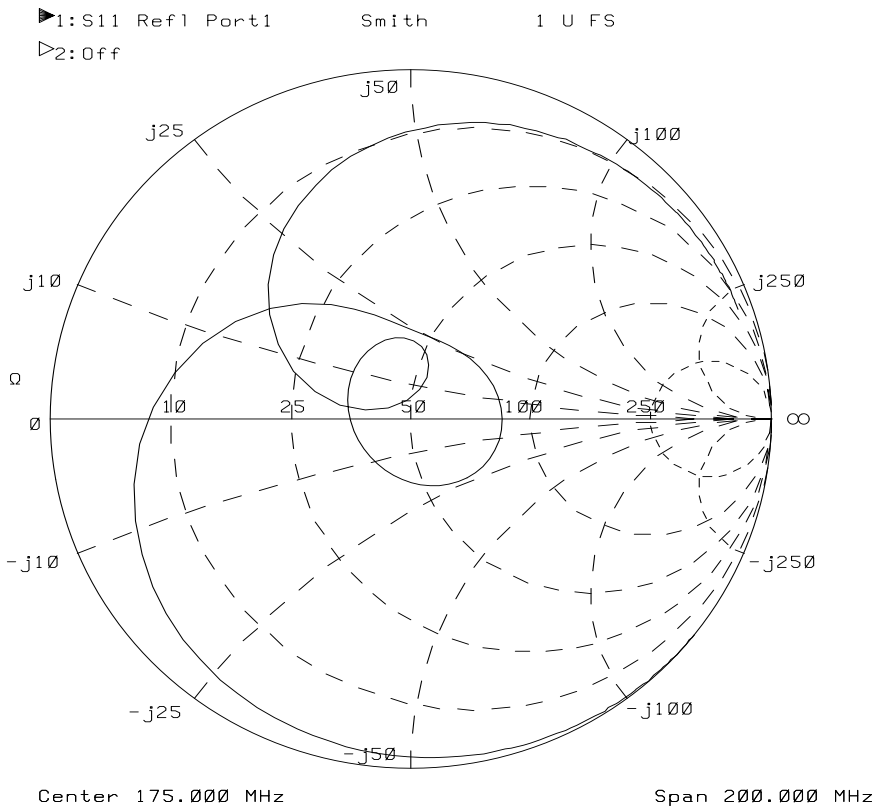

Measuring Impedance Magnitude

The impedance (Z) of a DUT can be calculated from the measured reflection or transmission coefficient. The impedance magnitude format allows measurement of impedance versus frequency or power. This measurement can be useful for many types of devices, including resonators and discrete passive components.

The analyzer measures the reflection or transmission response of the DUT, converts it to the equivalent complex impedance, and displays the magnitude. Two simple conversions are available, depending on the measurement configuration.

An accurate impedance measurement is highly dependent on a good calibration. The accuracy of the impedance measurement is best when the measurement results are near the analyzer's system impedance (50 or 75 ohms). The resolution is limited (by internal math calculations) to approximately 5 to 10 milliohms.

To use the impedance magnitude format, press **FORMAT**
More Format Impedance Magnitude.

How the Reflection Measurement Works

A reflection trace can be converted to equivalent impedance using the model and equations shown in [Figure 3-36, "Impedance Calculation for Reflection Measurements."](#) In the formula shown in [Figure 3-36](#), Γ is the complex reflection coefficient. The complex impedance, Z_{Ref} , is computed based on Γ and Z_0 . The analyzer displays the magnitude of Z_{Ref} . This measurement assumes a two-terminal device, connected between the analyzer's test ports.

Figure 3-36 Impedance Calculation for Reflection Measurements

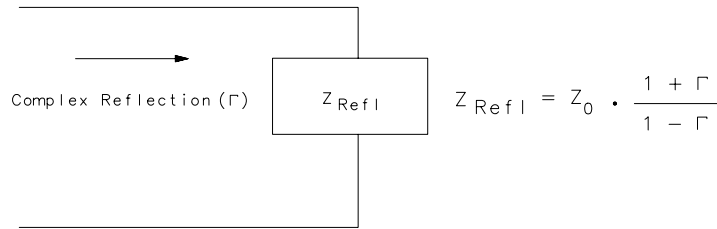

pp611c

How the Transmission Measurement Works

In a transmission measurement, the data can be converted to its equivalent mathematical series impedance using the model and equations shown in [Figure 3-37](#).

Figure 3-37 Impedance Calculation for Transmission Measurements

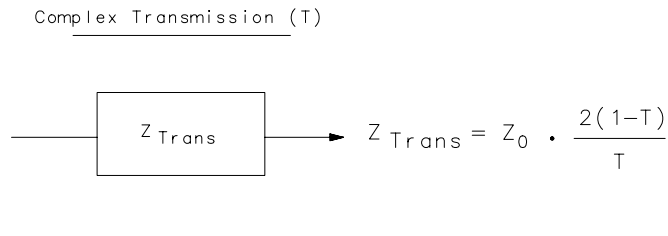

pp612c

In the formula shown above, T is the complex transmission response. The complex impedance, Z_{Trans} , is computed based on T and Z_0 . The analyzer displays the magnitude of Z_{Trans} . This is not the same as a two-port Z -parameter conversion, as only the measured parameter is used in the equations.

[Chapter 6](#) provides information about all of the calibrations available for transmission measurements. A two-port calibration is the most accurate form of error correction for transmission measurements since it accounts for all of the major sources of systematic error. Another possible calibration choice for a transmission measurement is the enhanced response calibration. However, since the enhanced response calibration

cannot correct for load match errors, the results of the transmission transform are less accurate than the reflection transform. To minimize these errors, a good load match is recommended. One way to achieve this is to use an attenuator on the load side of the device, as shown in [Figure 3-38](#). If you choose to do this, be sure to connect the attenuator before performing the enhanced response calibration.

When interpreting the resulting impedance measurement, remember that the analyzer is computing a transform and displaying the equivalent series impedance. If your device has significant shunt impedance, the results may differ significantly from the expected series impedance.

Figure 3-38 **Equipment Setup for a Transmission Measurement of Impedance Magnitude**

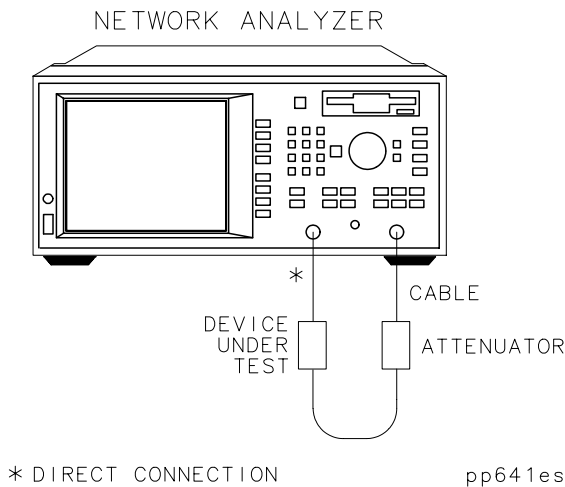

4 **Using Instrument Functions**

Introduction

This chapter explains some common analyzer functions that can help you to examine, store, and print measurement data.

The following functions are explained in this chapter:

- [“Using Markers” on page 4-3](#)
- [“Using Limit Testing” on page 4-28](#)
- [“Using Reference Tracking” on page 4-42](#)
- [“Customizing the Display” on page 4-45](#)
- [“Saving and Recalling Measurement Results” on page 4-57](#)
- [“Connecting and Configuring Printers and Plotters” on page 4-70](#)
- [“Printing and Plotting Measurement Results” on page 4-80](#)
- [“Using a Keyboard” on page 4-85](#)
- [“Using an External VGA Monitor” on page 4-89](#)

Using Markers

The markers provide numerical readout of trace data. Markers have a stimulus value (the x-axis value in a Cartesian format) and a response value (the y-axis value in a Cartesian format). In Smith chart format, markers have a stimulus value, a resistive value, a reactive value, and a complex impedance value. In polar format, markers have a stimulus value, a magnitude value, and a phase value.

When you switch on a marker, and no other function is active, the analyzer shows the marker stimulus value in the active entry area.



You can control markers with the front panel knob, the   keys, or the front panel numeric keypad. The markers are activated by pressing the **MARKER** key. See [Figure 4-1](#).

Figure 4-1

The MARKER Key

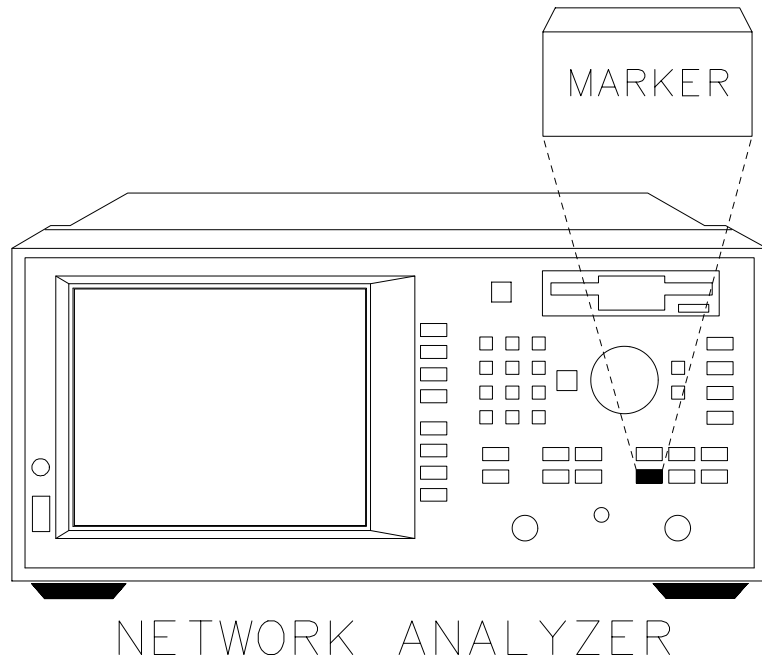

po619b.

NOTE

The frequency position of the markers is coupled between the two measurement channels. Changing the frequency of a marker on one measurement channel will also change the frequency of the marker on the other measurement channel.

The examples in this section are shown with an S_{21} forward transmission measurement of a filter. To follow along with these examples, use the filter that was shipped with your analyzer, connect the equipment as shown, and set up the analyzer by pressing the keys shown below [Figure 4-2](#).

Figure 4-2 **Connect the Filter to the Analyzer**

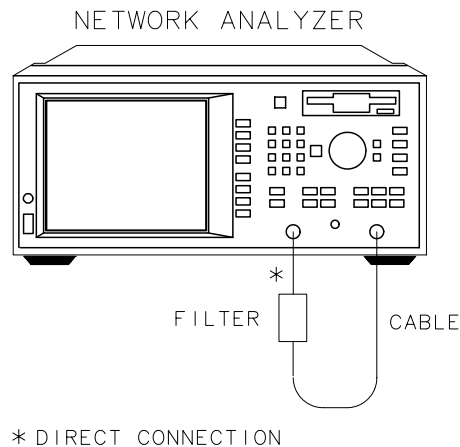

pp61es

PRESET
(**User Preset** or **Factory Preset**)
FREQ **Center** **175** **MHz**
Span **349** **MHz**
SCALE **Autoscale**

NOTE

When you make a hardcopy of your measurement results that contain displayed markers, you can choose to have a marker table appear on the hardcopy. Refer to [“Printing and Plotting Measurement Results”](#) on page 4-80.



To Activate Markers

1. Press the **MARKER** key to activate marker 1.
2. To activate markers 2 through 4, use the softkeys. For example, press softkey **3:** to activate marker 3. To activate markers 5 through 8, first press **More Markers** and then the softkey that corresponds to the marker you wish to activate.
3. Each marker, when activated, is either placed at its previous x-axis value, or at the center of the x-axis.

NOTE

Active Marker Definition

Although there may be up to eight markers on the display screen at one time, only one marker can be "active" at any given time. The active marker is designated by a triangle pointing down (▽) with the marker number above it. Any other markers on the display are inactive and are designated by a triangle pointing up (△) with the marker number below it. Any marker can be made active by selecting its corresponding softkey.

The active marker's values are always displayed in the upper-right corner of the display screen, and you can modify the stimulus value of the active marker using the front-panel knob, the   keys, or the numeric keypad.

To Turn Markers Off

1. All markers can be turned off by pressing **MARKER** **All Off**.
2. To turn off an individual marker, make it the active marker by pressing its corresponding softkey, and then press **Active Marker Off** (accessed by pressing **More Markers** if necessary).

To Use Marker Search Functions

Markers can be used to:

- search a measurement trace for maximum or minimum points
- search for a target value
- automatically calculate bandwidth or notch parameters of filters
- automatically search for multiple maximums or minimums

NOTE

Marker tracking can be useful for tuning DUTs when combined with the marker search functions. When tracking is turned on, the marker search is applied to the active marker and is updated with each sweep. To turn tracking on, press **(MARKER) Marker Search** and then select the type of search you will be performing. Then press **Prior Menu** (if necessary), and **Tracking on OFF**.

CAUTION

It is possible to select marker search types on measurement channel 1 that are incompatible with those on measurement channel 2, and vice versa. Doing so can cause the markers on the inactive channel to be moved. Be careful to ensure you are using the correct markers for the measurement channel you are currently measuring, especially when marker tracking is turned on.

To Use Max Search and Min Search

The maximum search functions scan for peak points on the measurement trace. The minimum search functions scan for minimum points on the measurement trace.

1. Press **Marker Search Max Search Mkr -> Max** to place marker 1 at the maximum value on the trace.
2. Press **Prior Menu Prior Menu 2: Marker Search Min Search Mkr -> Min** to place marker 2 at the minimum value on the trace.
3. **Figure 4-3** shows markers 1 and 2 at the maximum and minimum points, respectively.

Figure 4-3 **Markers at Minimum and Maximum Values**

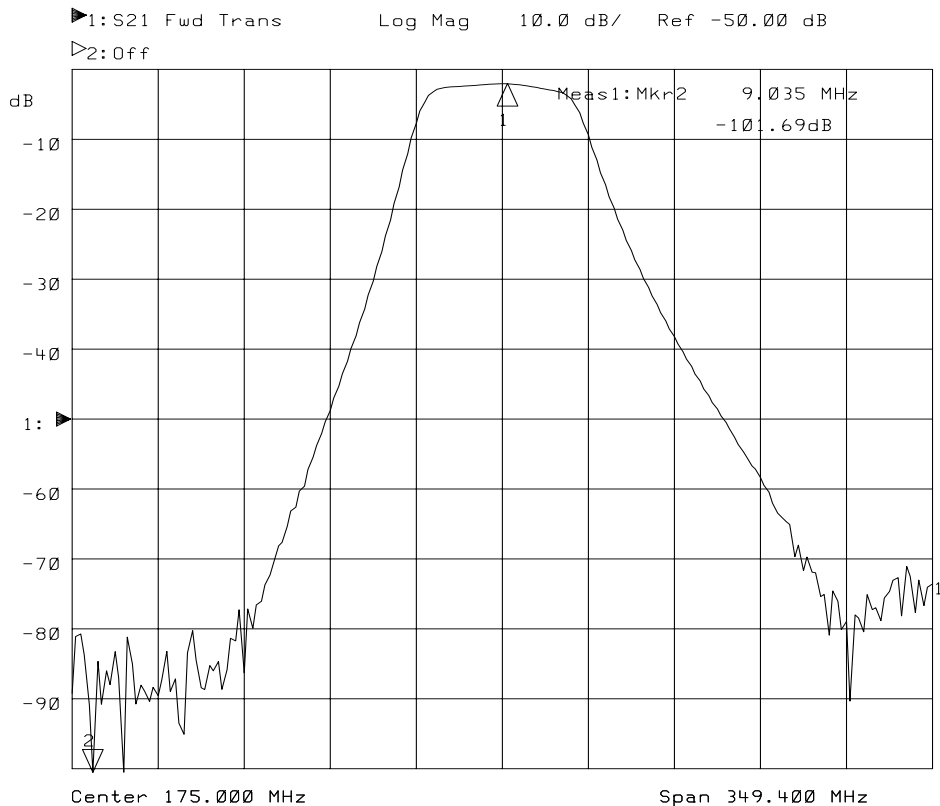

Using the Next Peak and Next Min Functions

As explained previously, pressing **Mkr -> Max** and **Mkr -> Min** will place a marker on the maximum and minimum points on the measurement trace, respectively. You can search for the next highest or lowest point using the **Next Peak Right**, **Next Peak Left**, **Next Min Right**, and **Next Min Left** keys.

A maximum (or minimum) point is detected whenever an amplitude excursion greater than half of a division occurs. The half of a division excursion requirement must be satisfied on both sides (left and right) of the peak (or minimum). The maximum (or minimum) point must be > -60 dB. See [Figure 4-4](#).

Figure 4-4 Peak and Minimum Search Criteria

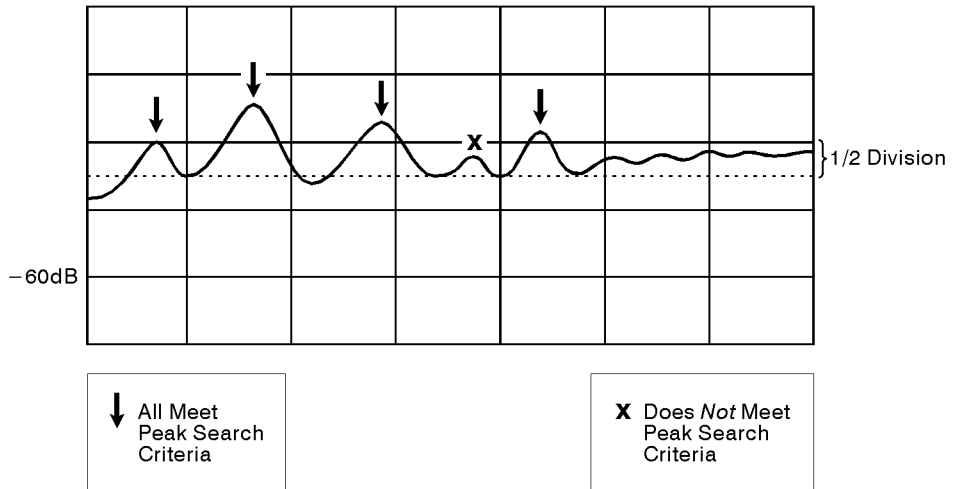

pp618c

When the maximum or minimum point is at or near either edge of the display, the excursion requirement is satisfied by a half of a division excursion on just one side of the maximum (or minimum). See [Figure 4-5](#).

Figure 4-5 Peak and Minimum Search Criteria at Display Endpoints

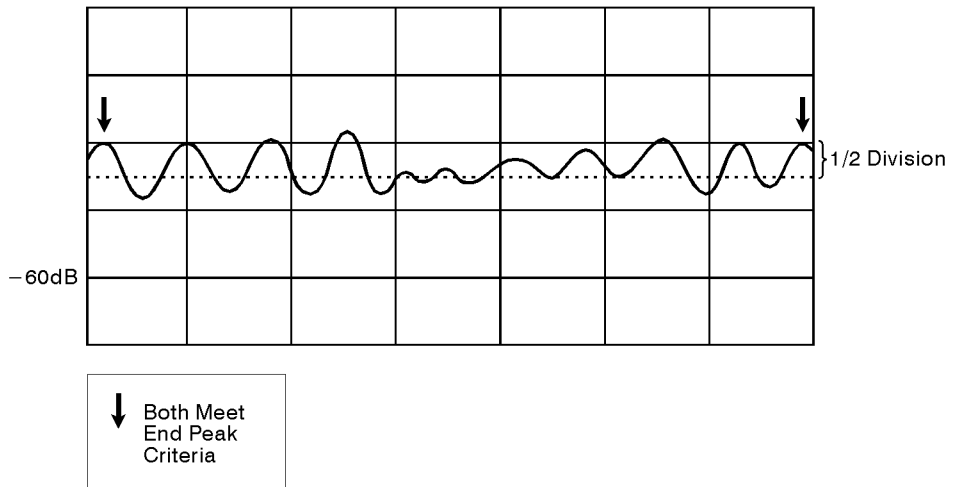

pp619c

To Search for Target Values

1. Press **Prior Menu** **Prior Menu** **All Off** **1: Marker Search** **Target Search** .
2. Press **Target Value** to choose the target level and enter the target value. (The default value is -3 dB.)
3. Press **Search Right** and notice the marker moves to the first occurrence of the target value to the right. The target value is in reference to 0 dB.
4. Press **Search Left** and notice the marker moves to the first occurrence of the target value to the left.
5. Each time you press **Search Right** or **Search Left** , the marker moves to the next occurrence of the target level. If no occurrence is found, the message, "Target not found." appears momentarily on the display.

To Search for Bandwidth Values

NOTE

The bandwidth search function is intended for transmission or power measurements in log mag format only.

1. Press **(MARKER)** **Marker Search** **Bandwidth** .

The bandwidth search feature analyzes a bandpass filter and calculates the bandwidth, center frequency, and Q (see note below) for the specified bandwidth level. (The default bandwidth search level is -3 dB.) The bandwidth information is displayed in the upper-right corner of the network analyzer screen. The bandwidth feature puts marker 1 in delta marker mode. (Delta marker mode is explained later in this chapter.)

NOTE

Center frequency is defined as the halfway point between the left and right bandwidth cutoff points.

Loss is the amplitude of the center frequency marker.

Q stands for "quality factor," and is defined as the ratio of a circuit's resonant frequency to its bandwidth. Your analyzer calculates Q as the center frequency divided by the bandwidth.

2. Press **(-6)** **(ENTER)** to change the -3 dB bandwidth target level to -6 dB.
3. If you want to change the marker frequency resolution, press **(FREQ)** **Disp Freq Resolution** and enter a different resolution value.

Each marker's dedicated use is listed in the following table. [Figure 4-6, “-6 dB Bandwidth Marker Search,”](#) shows a -6 dB bandwidth marker search on measurement channel 1.

Dedicated Use of Markers in Bandwidth Search Mode

Dedicated Use	Measurement Channel 1	Measurement Channel 2
maximum power value	marker 1	marker 2
center frequency of pass band ^a	marker 3	marker 4
bandwidth cutoff point (left)	marker 5	marker 7
bandwidth cutoff point (right)	marker 6	marker 8

- a. The center frequency is defined by the analyzer as the midpoint between the two bandwidth cutoff points.

Figure 4-6 **-6 dB Bandwidth Marker Search**

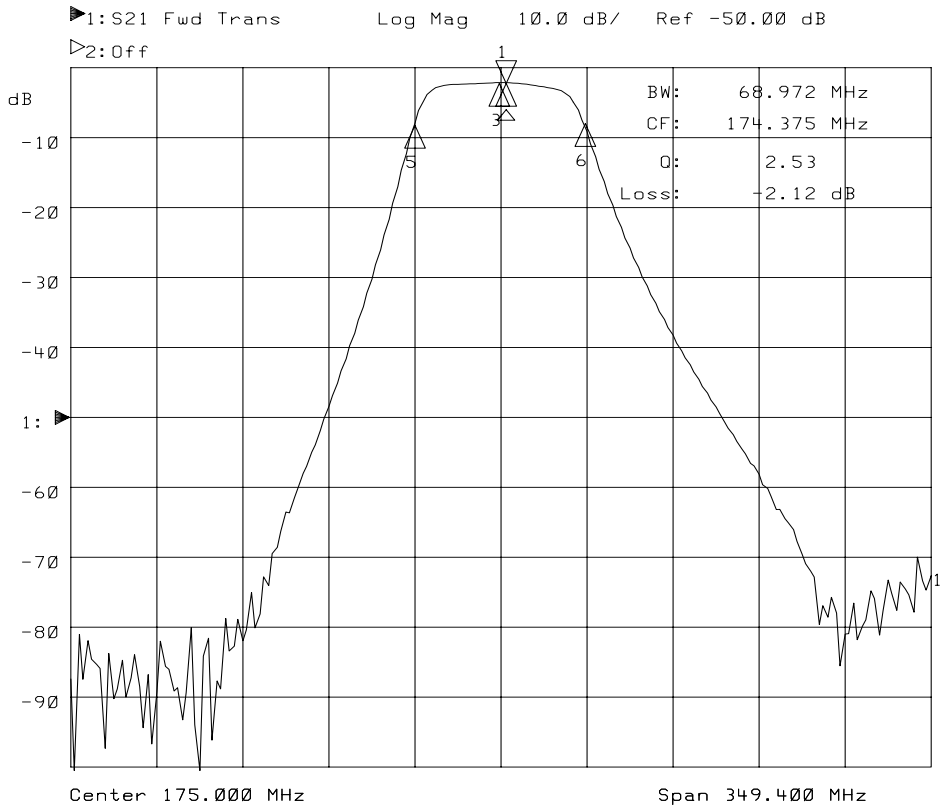

To Search for Notch Values

NOTE

The notch search function is intended for transmission or power measurements in log mag format only.

1. To follow along with this example, you will need to connect a notch filter to the analyzer in place of the bandpass filter shown in [Figure 4-2](#).
2. Press **MARKER** **All Off** **Marker Search** **Notch** .
3. The notch search feature analyzes a notch filter and calculates the bandwidth, center frequency, and Q (see note below) for the specified notch level. (The default notch search level is -6 dB.) The resulting information is displayed in the upper-right corner of the network analyzer screen. The notch feature puts marker 1 in delta marker mode. (Delta marker mode is explained later in this chapter.)

NOTE

Q stands for "quality factor," defined as the ratio of a circuit's resonant frequency to its bandwidth. Your analyzer calculates Q as the center frequency divided by the bandwidth.

Each marker's dedicated use is listed in the following table. [Figure 4-7](#) shows a -6 dB notch marker search on measurement channel 1.

Dedicated Use of Markers in Notch Search Mode

Dedicated Use	Measurement Channel 1	Measurement Channel 2
maximum power value	marker 1	marker 2
center frequency of stop band ^a	marker 3	marker 4
notch -n dB point ^b (left)	marker 5	marker 7
notch -n dB point ^b (right)	marker 6	marker 8

- a. The center frequency is defined by the analyzer as the midpoint between the left and right notch points.
- b. Where n is the target value, and the -n dB point is relative to the maximum response (marker 1). (The default value for -n is -6. A different value may be set using the SCPI command `CALC:MARK:NOTC`.)

Figure 4-7 **-6 dB Notch Marker Search**

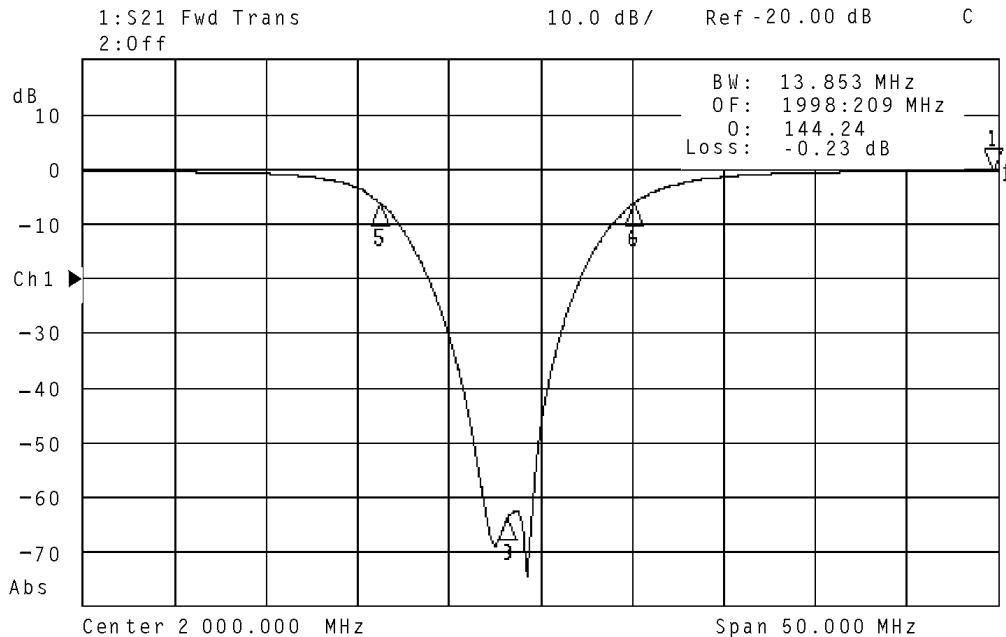

pp649es

To Use Multi-Peak or Multi-Notch Search

Multi-peak and multi-notch searches are designed for use when measuring multi-pole filters. Both automatically search the measurement trace from left to right, and position a marker at each local maximum or minimum. Up to eight maximums or minimums will be found. Searches are limited to responses above -60 dB. With marker tracking on, the multi-peak/notch search will be performed after each sweep.

NOTE

During a multi-peak or multi-notch search, eight markers are always placed on the trace, regardless of how many peaks or notches are found. The markers that aren't placed on a peak or notch are placed at the far right of the display on the current maximum frequency point.

A maximum (or minimum) point is detected whenever an amplitude excursion greater than half of a division occurs. The half of a division excursion requirement must be satisfied on both sides (left and right) of the peak (or minimum). The maximum (or minimum) point must be > -60 dB. See [Figure 4-8](#).

Figure 4-8 Peak and Minimum Search Criteria

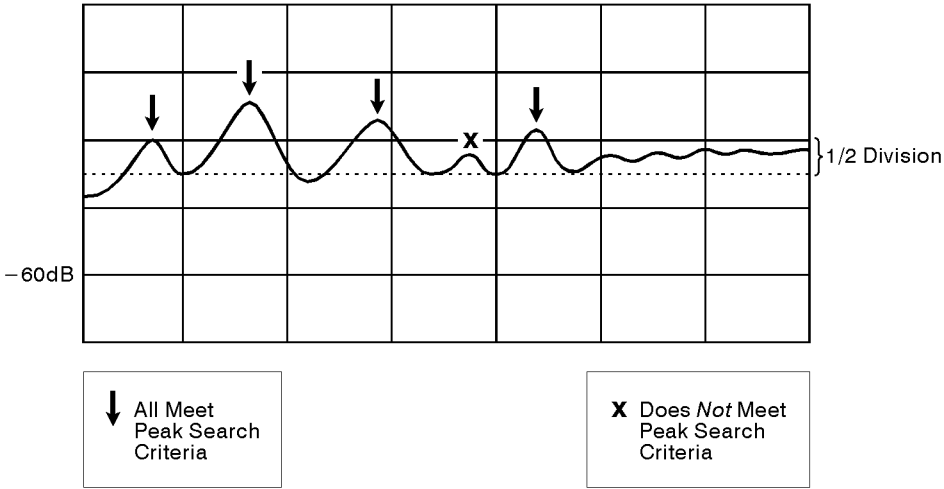

pp618c

When the maximum or minimum point is at or near either edge of the display, the excursion requirement is satisfied by a half of a division excursion on just one side of the maximum (or minimum). See [Figure 4-9](#).

Figure 4-9 Peak and Minimum Search Criteria at Display Endpoints

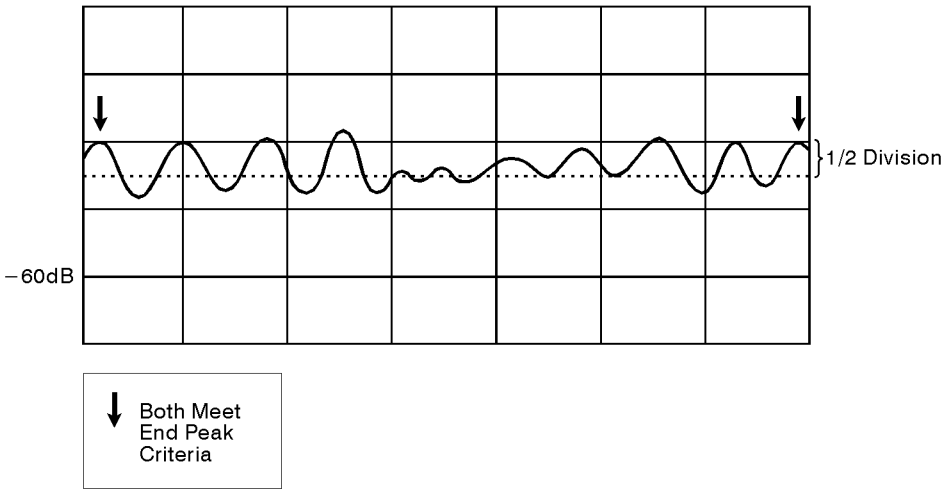

pp619c

Connect a multi-pole filter and press **(MARKER)** **Marker Search** **More** and **Multi Peak** if measuring a multi-pole bandpass filter, or **MultiNotch** if measuring a multi-pole notch filter.

See [Figure 4-10](#), “Multi-Peak Search Mode,” and [Figure 4-11](#), “Multi-Notch Search Mode,” for examples of a multi-peak and a multi-notch search, respectively.

Figure 4-10 Multi-Peak Search Mode

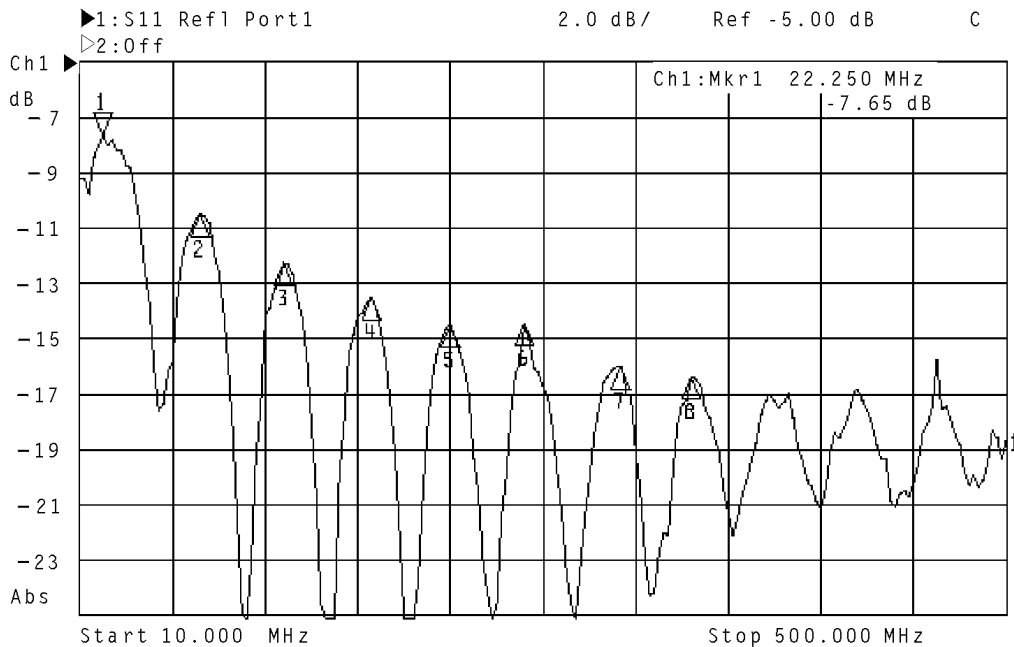

pp650es

Figure 4-11 Multi-Notch Search Mode

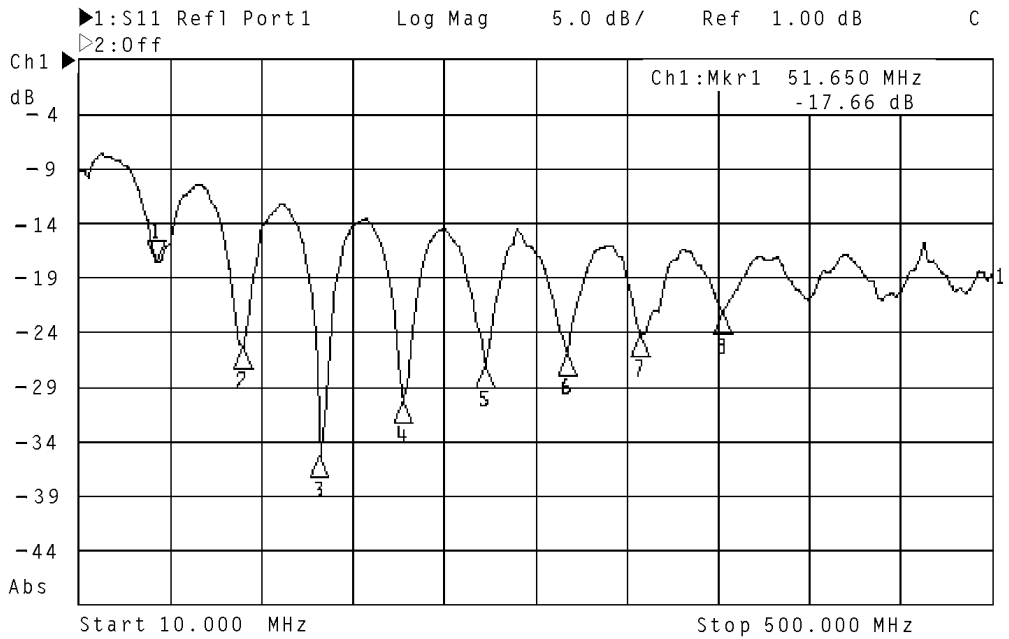

pp651es

To Use Marker Math Functions

The three marker math functions—statistics, flatness, and RF filter stats—perform certain mathematical calculations on the amplitude data of user-defined trace segments.

For measurement channel 1, the trace segment is defined with markers 1 and 2; for measurement channel 2, the trace segment is defined with markers 3 and 4. The marker math parameters are updated after each sweep, as well as any time a marker is moved. Regular marker tracking is not available with the marker math functions.

NOTE

You cannot have marker math functions active at the same time as marker search functions.

To Use Marker Statistics

The marker statistics function measures a user-defined segment of the measurement trace and calculates the following:

- frequency span
- mean amplitude
- standard deviation of the amplitude response
- peak-to-peak ripple

Limit testing may be performed on the statistical mean and peak-to-peak ripple. See [“To Use Marker Limit Functions” on page 4-32](#) for information.

1. On measurement channel 1, press **MARKER** and set markers 1 and 2 to define the beginning and end of the trace segment that you want to measure. (When using measurement channel 2, use markers 3 and 4 to define the trace segment.)
2. Press **Marker Functions** **Marker Math** **Statistics** .
3. [Figure 4-12, “Marker Statistics Function,”](#) shows a defined trace segment. Notice the marker readout in the upper right corner of the display.

Figure 4-12 **Marker Statistics Function**

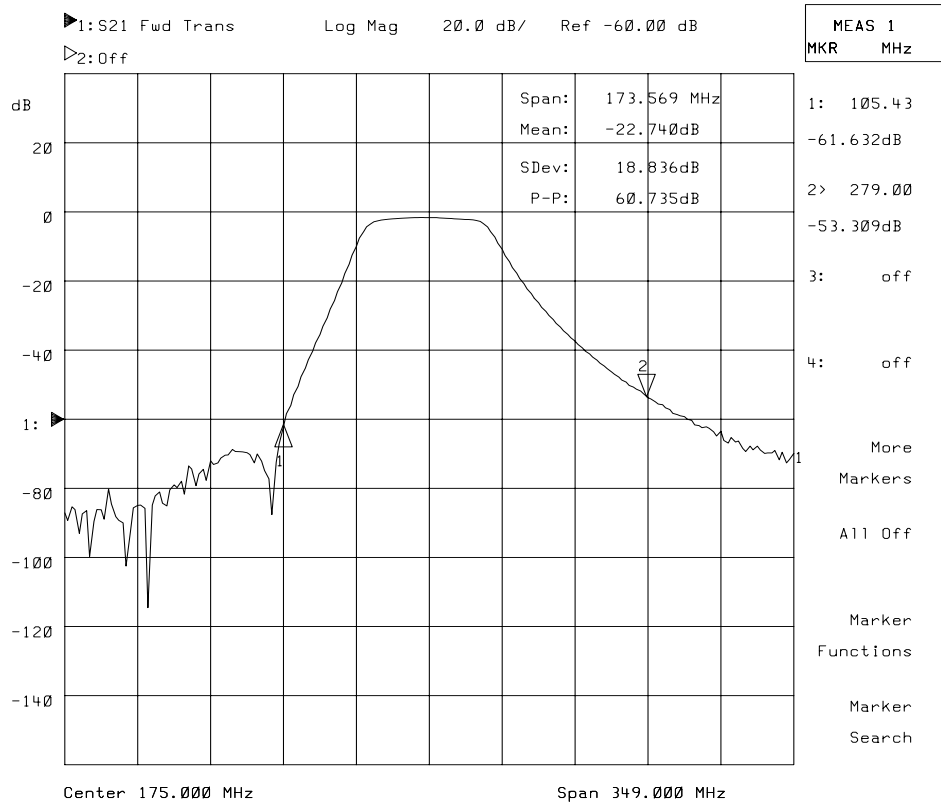

To Use Marker Flatness

The marker flatness search function measures a user-defined segment of the measurement trace and calculates the following:

- frequency span
- gain
- slope
- flatness

The analyzer calculates flatness by drawing a straight line between the markers. A maximum vertical deviation from this line is computed for each measurement point. Flatness is the magnitude difference of the maximum and minimum calculated deviations from the straight line.

Limit testing may be performed on the flatness parameter. See [“To Use Marker Limit Functions” on page 4-32](#) for information.

1. On measurement channel 1, press **MARKER** and set markers 1 and 2 to define the beginning and end of the trace segment that you want to measure. (When using measurement channel 2, use markers 3 and 4 to define the trace segment.)
2. Press **Marker Functions** **Marker Math** **Flatness** .
3. [Figure 4-13, “Marker Flatness Function,”](#) shows a defined trace segment. Notice the marker readout in the upper right corner of the display.

Figure 4-13 **Marker Flatness Function**

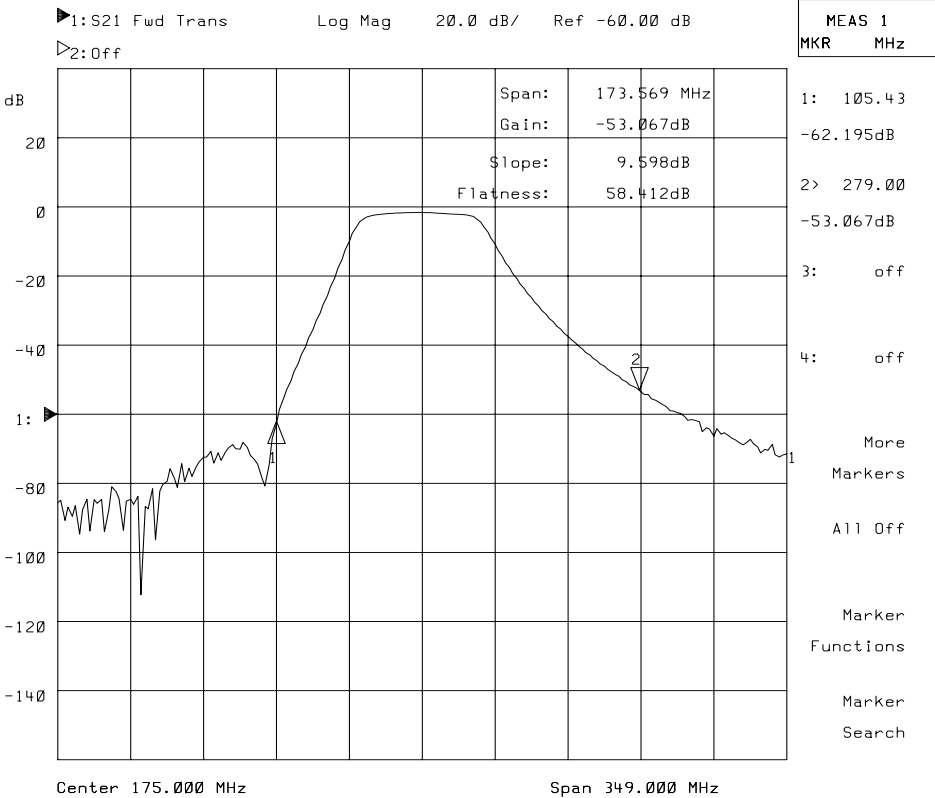

To Use RF Filter Statistics

The RF filter statistics function measures both the passband and the stopband (reject-band) of a filter with a single sweep.

1. On measurement channel 1, press **MARKER** and place marker 1 at the beginning of the passband and marker 2 at the end of the passband. Place markers 3 and 4 at the beginning and end of the stopband. (When using measurement channel 2, use markers 5 through 8 to define the passband and stopband.)
2. Press **Marker Functions** **Marker Math** **RF Filter Stats**.
3. At the end of each sweep, this feature calculates the insertion loss and peak-to-peak ripple of the passband, as well as the maximum signal amplitude in the stopband. The insertion loss is defined as the minimum point between markers 1 and 2 with respect to 0 dB. The peak-to-peak ripple of the passband is defined as the difference between the maximum and minimum points in the passband (as defined by markers 1 and 2). The reject parameter is defined as the difference between the minimum point in the passband and the maximum point in the stopband.
4. See [Figure 4-14](#) for an example of an RF filter statistics search.

Figure 4-14 RF Filter Statistics Function

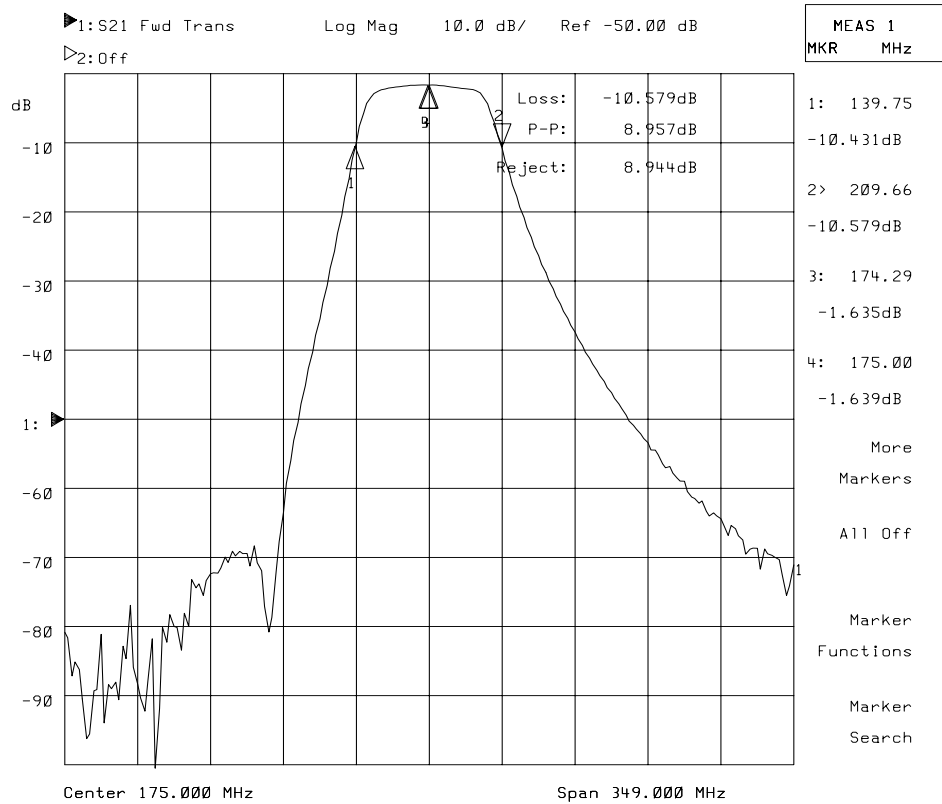

To Use Delta (Δ) Marker Mode

In delta marker mode, a reference marker is placed at the active marker position. All marker values are then displayed in reference to this delta marker. When the amplitude of the measurement trace changes, the reference marker value also changes. The delta marker is represented by a triangle pointing up (Δ) with a delta symbol (Δ) below it rather than a number.

Limit testing can be performed on delta amplitude and delta frequency using specific markers. See “[To Use Marker Limit Functions](#)” on [page 4-32](#) chapter.

To follow along with this example, set up the instrument for an S_{21} forward transmission measurement of the bandpass filter that was shipped with your instrument.

1. Press **MARKER** **All Off** **Marker Search** **Max Search** **Mkr -> Max** to move marker 1 (the active marker) to the maximum value on the trace.
2. Press **Prior Menu** **Prior Menu** **Marker Functions** **Delta Mkr ON** to place a reference marker at the active marker position.
3. Press **Prior Menu** **Marker Search** **Min Search** **Mkr -> Min** to place marker 1 to the minimum point on the trace.
4. The difference between the markers' frequency and amplitude value is shown in the upper-right corner of the analyzer screen.
5. Press **Prior Menu** **Prior Menu** **2:** . Use the front panel knob to move marker 2 towards the right-hand side of the display screen. Note that the marker 2 values are also in reference to the delta marker.

Figure 4-15 **Delta Marker Mode**

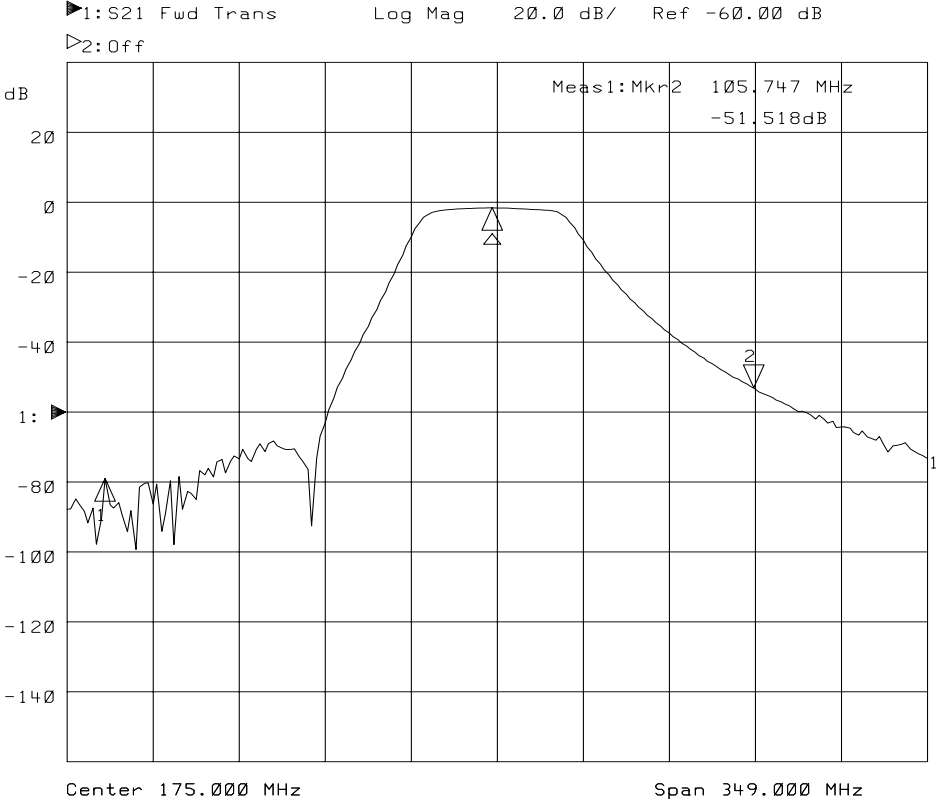

To Use Other Marker Functions

To Use Marker to Center Frequency

The marker to center frequency function changes the analyzer's center frequency to that of the active marker and limits the span if necessary. If the markers are all off, and this function is selected, it first turns on marker 1 at its previous setting or, if no previous setting, at the center frequency (default).

1. Press **MARKER** and then use the front panel knob or the numeric keypad to move the marker to 200 MHz.
2. Press **Marker Functions** **Marker** → **Center** and note that the trace has now shifted and that the center frequency of the analyzer is now 200 MHz.

To Use Marker to Reference

The marker to reference function changes the value of the analyzer's reference level to the amplitude value of the active marker. This function does not change the reference *position*. If the markers are all off, and this function is selected, it first turns on marker 1 at its previous setting or, if no previous setting, at the center frequency (default).

1. Press **MARKER** and then use the front panel knob or the numeric keypad to move the marker to about -10 dB.
2. Press **Marker Functions** **Marker** → **Reference** and note that the trace has now shifted up and that the marker is exactly on the reference level.

To Use Marker to Electrical Delay

The marker to electrical delay function allows you to mathematically subtract or add enough line length to the receiver input to compensate for the phase slope at the active marker position. This effectively flattens the phase trace around the active marker. You can use this to measure the electrical length or deviation from linear phase. To access this marker function, press **Marker Functions** **Marker** → **Elec Delay**. See **Electrical Delay** in [Chapter 8, "Hardkey/Softkey Reference,"](#) for more information.

See ["Compensating for Phase Shift in Measurement Setups" on page 5-18](#) in for more information on electrical delay.

To Use Polar Format Markers

The analyzer displays the polar marker values as magnitude and phase. You can use these markers only when you are viewing a polar display format. The polar format is accessed by pressing **FORMAT** **Polar**.

To Use Smith Chart Markers

In Smith chart format, markers have a resistive value, a reactive value, and a complex impedance value. The Smith chart format is accessed by pressing **FORMAT** **Smith Chart**. For information on interpreting Smith chart values, see [“Measuring Impedance using the Smith Chart” on page 3-74](#).

Using Limit Testing

Limit testing is a measurement technique that compares measurement data to constraints that you define. Depending on the results of this comparison, the analyzer can indicate if your device either passes or fails the test.

Limit testing is useful for real-time tuning of devices to specifications. When limit testing is turned on, pass/fail results can be output to the display and also to the LIMIT TEST TTL IN/OUT connector on the rear panel. See “[Analyzer Connectors—Rear Panel BNC Connectors](#)” on [page 7-4](#) for more information.

Limit testing is implemented by creating individual flat, sloping, or single point limits on the analyzer display. These types of lines may be used individually or combined to represent the performance parameters for your device under test. Also available are limit testing capabilities for five types of marker searches: statistical mean, peak-to-peak ripple, flatness, delta amplitude, and delta frequency.

NOTE

Limit testing is only performed on the measurement data trace. It cannot be performed on a memory trace.

NOTE

Limit line testing is not available when the analyzer is in Smith chart or polar format. If limit lines are on and you change to Smith chart or polar format, the analyzer will automatically turn off the limit line(s).

The following examples are performed using an S_{21} forward transmission measurement of the bandpass filter shipped with your instrument. To follow along with these examples, connect your filter to the analyzer and press:

```
PRESET
( User Preset or Factory Preset )
FREQ Center 175 MHz
Span 200 MHz
SCALE 5 Enter
Reference Level -15 Enter
```

To Create a Flat Limit Line

In this example, you will create a minimum limit line from 155 MHz to 195 MHz at a level of -3 dB.

1. To access the limit line menu, press **(DISPLAY) Limit Menu** .
2. To create a new minimum limit line, press **Add Limit Add Min Line** .
3. Press **Begin Frequency** , and enter **(155) MHz** .
4. Press **End Frequency** , and enter **(195) MHz** .
5. Press **Begin Limit** , and press **(-3) Enter** .
6. Press **End Limit** , and press **(-3) Enter** .
7. Notice that the analyzer has generated a limit line at about the center of the display.
8. To get a less distracting view of the limit line, press **(DISPLAY) More Display Graticule ON off** to toggle the graticule off.
9. To see if your filter meets the minimum limit you have just set up, press **Prior Menu Limit Menu Limit Test ON** .
10. The display will now indicate whether the DUT has passed or failed when compared to the current limits. If you are using the filter that was shipped with your instrument, you should see a PASS indicator.

To edit a current limit line and to see what a fail indicator looks like, press **Edit Limit** and set the **Begin Limit** and **End Limit** to 0 dB.
11. Notice the display now shows the FAIL  indicator.

NOTE

You can move the position of the pass/fail indicator, turn on or off the pass/fail text, and turn on or off the fail icon in the limit options menu. Press **(DISPLAY) Limit Menu Limit Options** . For more information, see [“Customizing the Display” on page 4-45](#).



12. Before continuing to the next section, edit the limit line to change it back to having a begin and end limit of -3 dB.

To Create a Sloping Limit Line

A sloping limit line has different values for its begin and end limits. In this example, you will create a sloping limit line between 130 MHz and 155 MHz with a beginning level of -35 dB and an ending level of -3 dB.

1. Press **Prior Menu** **Add Limit** **Add Min Line**
Begin Frequency **MHz** .
2. Press **End Frequency** **MHz** .
3. Press **Begin Limit** **Enter** .
4. Press **End Limit** **Enter** .

NOTE

When creating limit lines, you can enter frequency and limit values using the front panel knob or the   keys as well as the numeric keypad.

[Figure 4-16, "Limit Lines,"](#) shows limit lines that dictate the specified shape of a bandpass filter. In this example, a filter was connected to the analyzer and tuned so that its response was within the created limit lines. The pass/fail indicator gives constant feedback regarding test status.

Figure 4-16 **Limit Lines**

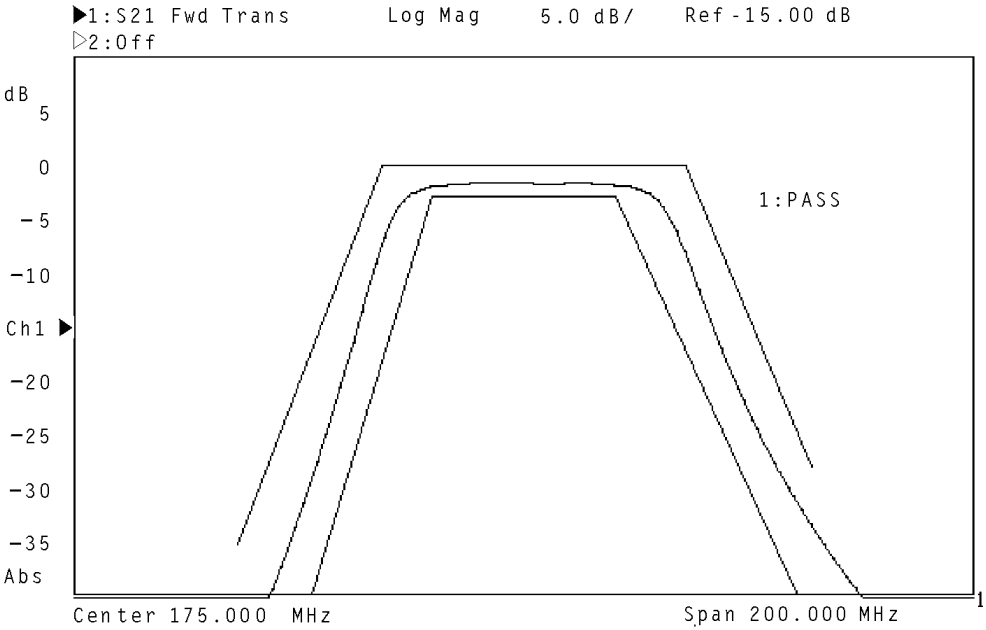

pp652es

To Create a Single Point Limit

Sometimes you may only be interested in the power level at one particular frequency. In this case, you may wish to use a single point limit. In the following example, use the setup from the previous examples and assume that your bandpass filter's specified insertion loss at 174 MHz must be less than 3 dB. The following instructions create a -3 dB single point limit at 174 MHz.

CAUTION

Limit tests are only performed on actual data points, *not* the interpolated values between. When setting a single point limit, the limit is actually applied to the closest data point to the frequency of the set limit. See [“Additional Notes on Limit Testing” on page 4-39](#) for more information.

1. Press **Prior Menu** **Add Limit** **Add Min Point** .
2. Press **Frequency** **174** **MHz** .
3. Press **Limit** **-3** **Enter** .

To Use Marker Limit Functions

The following marker limit test types are available in the marker limit table:

- Statistic: Mean
- Statistic: p-p
- Flatness
- Delta Ampl
- Delta Freq

You can use pass/fail limit testing on three parameters of the marker math functions: statistical mean, peak-to-peak ripple, and flatness. (See [“To Use Marker Statistics” on page 4-18](#) and [“To Use Marker Flatness” on page 4-20](#) for more information on these types of searches.) You can also use specific markers to limit-test delta amplitude and delta frequency.

All of these special marker limit functions can be used in conjunction with regular limit line testing.

Statistical Mean

1. This limit test requires that you first define a segment on the measurement trace using markers 1 and 2 (or markers 3 and 4 for measurement channel 2). Then press **(MARKER)** **Marker Functions** **Marker Math** **Statistics** to enable the statistics marker search. See [“To Use Marker Statistics” on page 4-18](#) for more information on using marker statistics.
2. Press **(DISPLAY)** **Limit Menu** **Mkr Limits** .
3. Use the front panel knob or the **(↑)** **(↓)** keys to select **Statistic: Mean** in the marker limit test table. Turn this limit function on by pressing the **Mkr Limit on OFF** key. Note that the entry in the on/off column of the table changes to "on."
4. Press **Edit Limit (Min/Max)** **Max Limit** and enter the maximum limit using the front panel keypad and terminating the entry with the **(ENTER)** key.
5. Press **Prior Menu** **Edit Limit (Min/Max)** **Min Limit** , and enter the minimum limit using the front panel keypad and terminating the entry with the **(ENTER)** key.

NOTE

Note that there are no visible limit lines or indicators on the display with this limit test function. Therefore the **Limit Line on OFF** function has no effect when using marker limits.

Peak-to-Peak Ripple

1. This limit test requires that you first define a segment on the measurement trace using markers 1 and 2 (or markers 3 and 4 for measurement channel 2). Then press **(MARKER)** **Marker Functions** **Marker Math** **Statistics** to enable the statistics marker search. See [“To Use Marker Statistics” on page 4-18](#) for more information on using marker statistics.
2. Press **(DISPLAY)** **Limit Menu** **Mkr Limits** .
3. Use the front panel knob or the **(↑)** **(↓)** keys to select **Statistic: p-p** in the marker limit test table. Turn this limit function on by pressing the **Mkr Limit on OFF** key. Note that the entry in the on/off column of the table changes to "on."
4. Press **Edit Limit (Min/Max)** **Max Limit** and enter the maximum limit using the front panel keypad and terminating the entry with the **(ENTER)** key.

5. Press **Prior Menu** **Edit Limit (Min/Max)** **Min Limit** and enter the minimum limit using the front panel keypad and terminating the entry with the **(ENTER)** key.

NOTE

Note that there are no visible limit lines or indicators on the display with this limit test function. Therefore the **Limit Line on OFF** function has no effect when using marker limits.

Flatness





1. This limit test requires that you first define a segment on the measurement trace using markers 1 and 2 (or markers 3 and 4 for measurement channel 2). Then press **(MARKER)** **Marker Functions** **Marker Math** **Flatness** to enable the statistics marker search. See [“To Use Marker Flatness” on page 4-20](#) for more information on using marker statistics.
2. Press **(DISPLAY)** **Limit Menu** **Mkr Limits** .
3. Use the front panel knob or the **(HOME)** **(LEFT)** keys to select **Flatness** in the marker limit test table. Turn this limit function on by pressing the **Mkr Limit on OFF** key. Note that the entry in the on/off column of the table changes to "on."
4. Press **Edit Limit (Min/Max)** **Max Limit** , and enter the maximum limit using the front panel keypad and terminating the entry with the **(ENTER)** key.
5. Press **Prior Menu** **Edit Limit (Min/Max)** **Min Limit** , and enter the minimum limit using the front panel keypad and terminating the entry with the **(ENTER)** key.

NOTE

Note that there are no visible limit lines or indicators on the display with this limit test function. Therefore the **Limit Line on OFF** function has no effect when using marker limits.





Delta Amplitude

This marker limit test allows you to set marker 1 as an amplitude reference against which marker 2 is limit tested.

1. This limit test requires that you first use marker 1 to determine the reference amplitude: Press **(MARKER) 1:** , and then use the front panel knob or the   keys to place marker 1 at the desired place on the measurement trace. The amplitude of marker 1 at this point becomes the delta reference for this marker limit test.
2. Press **(DISPLAY) Limit Menu Mkr Limits** .
3. Use the front panel knob or the   keys to select **Delta Amp1** in the marker limit test table. Turn this limit function on by pressing the **Mkr Limit on OFF** key. Note that the entry in the on/off column of the table changes to "on."
4. Press **Edit Limit (Min/Max) Max Limit** , and enter the maximum limit using the front panel keypad and terminating the entry with the **(ENTER)** key.
5. Press **Prior Menu Edit Limit (Min/Max) Min Limit** , and enter the minimum limit using the front panel keypad and terminating the entry with the **(ENTER)** key.

Delta Frequency

This marker limit test allows you to set marker 1 as a frequency reference against which marker 2 is limit tested.

1. This limit test requires that you first use marker 1 to determine the reference frequency: Press **(MARKER) 1:** , and then use the front panel knob or the   keys to place marker 1 at the desired place on the measurement trace. The frequency of marker 1 at this point becomes the delta reference for this marker limit test.
2. Press **(DISPLAY) Limit Menu Mkr Limits** .
3. Use the front panel knob or the   keys to select **Delta Freq** in the marker limit test table. Turn this limit function on by pressing the **Mkr Limit on OFF** key. Note that the entry in the on/off column of the table changes to "on."
4. Press **Edit Limit (Min/Max) Max Limit** , and enter the maximum limit using the front panel keypad and terminating the entry with the **(ENTER)** key.
5. Press **Prior Menu Edit Limit (Min/Max) Min Limit** , and enter the minimum limit using the front panel keypad and terminating the entry with the **(ENTER)** key.

To Use Relative Limits

There may be times when you are interested in the shape of a measurement trace, but not concerned with the absolute amplitude. For example, [Figure 4-16 on page 4-31](#) shows limit lines created for tuning a filter to a particular shape. If the shape is more important than the amplitude, you can make the limit lines relative to the peak point of the trace using the reference tracking function.

In this example, you would press **SCALE** **Reference Tracking** **Track Peak**. The limit lines are now relative to the peak point on the measurement trace rather than set at an absolute amplitude.



For more information on reference tracking, see [“Using Reference Tracking” on page 4-42](#).

Other Limit Line Functions

To Turn Limit Lines On and Off

Using the **Limit Line ON off** softkey toggles any created limit lines on and off; it does not delete them. You can still use the limit test function (pass/fail) without the limit lines appearing on the display screen. To access this key, press **DISPLAY** **Limit Menu** **Limit Options** .





To Delete Limit Lines

1. To select a limit line or point to delete, you must be in the main limit line menu.
2. To easily ensure you are in the main limit line menu, press **DISPLAY** **Limit Menu** .
3. Use the front panel knob or the   keys to select the limit you wish to delete. The selected limit will appear in inverse video in the limit table.
4. Press **Delete Limit** . The analyzer then gives you the option to cancel the deletion, go ahead with the individual deletion, or delete all the currently set limits.

To Move the Pass/Fail Indicator Text and Icon

The limit test pass/fail indicator and text can be moved to any position on the display screen.

To move the position of the pass/fail indicator:

1. Press **DISPLAY** **Limit Menu** **Limit Options** .
2. Press **Limit Icon X Position** and use the front panel knob or the   keys to position the pass/fail indicator along the horizontal axis. You can also place the indicator along the horizontal axis by entering a percentage using the numeric keypad. Enter a whole number from 0 to 100, where 0 represents the far left of the display, and 100 represents the far right of the display.
3. Press **Limit Icon Y Position** and use the front panel knob or the   keys to position the pass/fail indicator along the vertical axis. You can also place the indicator along the vertical axis by entering a percentage using the numeric keypad. Enter a whole number from 0 to 100, where 0 represents the bottom of the display, and 100 represents the top of the display.

**To Turn the
Pass/Fail
Indicator Text and
Icon On and Off**

You can toggle on or off the pass/fail indicator text (which contains the measurement channel number and the word "pass" or "fail," such as 1: FAIL) by pressing **DISPLAY** **Limit Menu** **Limit Options** **Limit Icon ON off**.

You can toggle on or off the fail icon (there is no "pass" icon—only text) by pressing **DISPLAY** **Limit Menu** **Limit Options** **Limit Icon ON off**.

**Using a Marker
During Limit Entry**

Pressing the **MARKER** softkey while entering a limit line will activate a marker. The marker can be used to determine a frequency or level of interest on the device response.

Additional Notes on Limit Testing

Stimulus and Amplitude Values

In frequency sweep mode, the stimulus values are interpreted as frequencies; in power sweep mode, the stimulus values are interpreted as output power levels.

CAUTION

The values entered for stimulus and amplitude are unitless. If the measurement format is changed after limit lines are set, the amplitude values do not automatically change. Therefore, you should select the format you want to use *before* entering your limits.

Calculating the Frequency of a Data Point

The frequency of each data point is calculated using the following formula:

$$Freq(pt\ number) = \frac{(pt\ number - 1) \times (stop\ freq - start\ freq)}{number\ of\ points - 1} + start\ freq$$

where *pt number* ranges from 1 (for the leftmost display point) to *number of points* (the rightmost display point).

Limit Testing and Measurement Points

Limit testing is only performed on actual data points, *not* interpolated values between them. The limit lines or points that you enter are converted to values at each measurement point. Most of the time this has little or no effect on the validity of the limit testing. However, note the following examples of problems that could arise when using limit lines.

Example 1

When using a small number of measurement points, limit lines must be set carefully, or the results may be confusing. The following illustration shows a data trace with three measurement points: A, B, and C, along with a minimum limit line.

Figure 4-17 **Limit Lines Example 1**

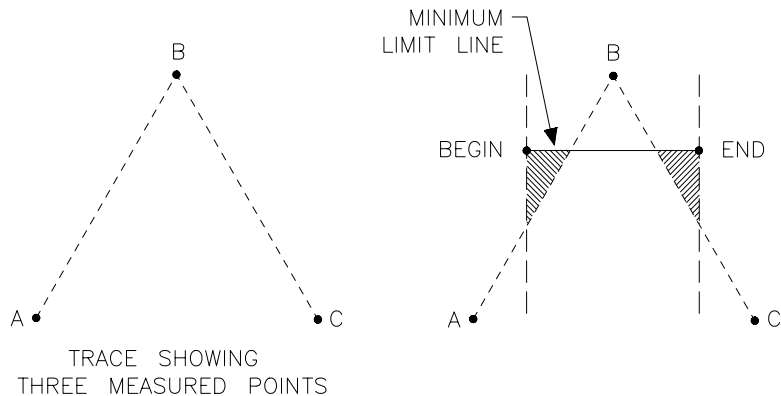

po65

Note that the beginning of the limit line falls between points A and B along the horizontal frequency axis. The end of the limit line falls between points B and C along the frequency axis. Therefore, only one measurement point is encountered between the beginning and end of the limit line. This particular example would result in a limit test result of "PASS" when it appears that it could fail. More measurement points are needed to evaluate this measurement.

Example 2

In this example, the analyzer has been set up with the following parameters:

- Start frequency = 90 MHz
- Stop frequency = 210 MHz
- Number of points = 11
- Maximum limit line begin frequency = 90 MHz
- Maximum limit line end frequency = 200 MHz

Refer to the illustration below for the discussion. Around 199 MHz, the data trace crosses through the limit line, and thus appears to have failed the test. However, the analyzer shows the `PASS` indicator because the last point *tested* is at 198 MHz. The last point displayed (210 MHz) does not cause the limit test to fail because it is past the limit line end frequency of 200 MHz.

Figure 4-18

Limit Lines Example 2

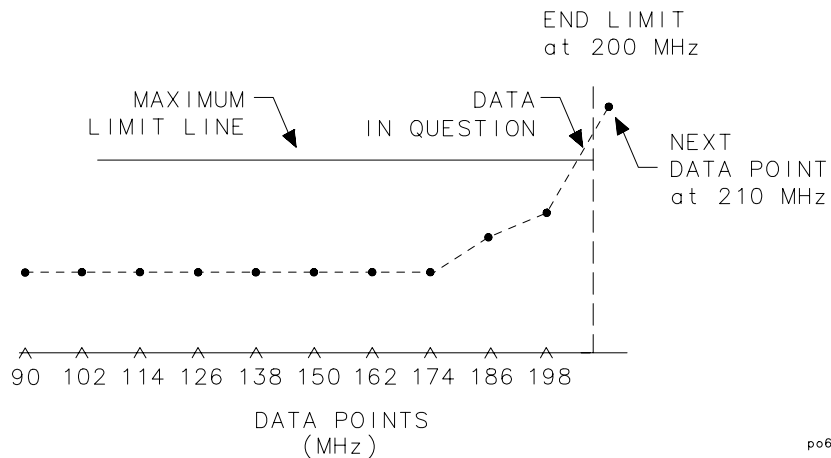

po654b

Using Reference Tracking

The reference tracking functions allow you to track either the peak point or a certain frequency of a measurement trace. It does this by adjusting the reference level with each sweep so that the point of interest always falls on the display reference line.

When reference tracking is on, marker values are displayed relative to the point of interest. Limit lines are also displayed relative to the point of interest when reference tracking is on. You may want to use relative limits when the shape of a measurement trace is more important than the absolute amplitude. See [“To Use Relative Limits” on page 4-36](#) for an example of using relative limit lines.

To Track the Peak Point

1. If you want to move the reference position (indicated by the ► symbol on the left side of the display), press **SCALE** **Reference Position** and then use the front panel knob, the **↑** **↓** keys, or the numeric keypad to enter a new reference position. A number is assigned to each possible reference position. See [Figure 4-19](#).



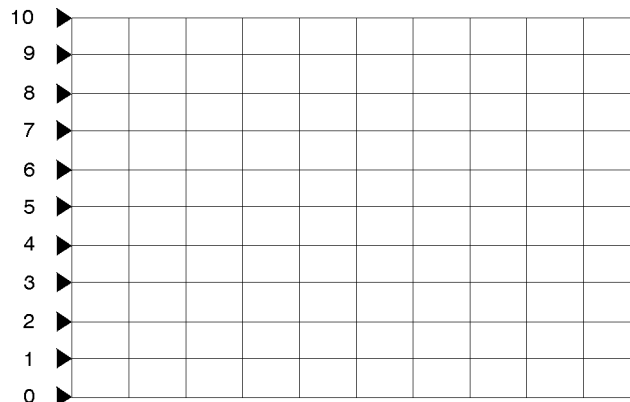

Figure 4-19 Reference Positions



po652b_c

2. Press **SCALE** **Reference Tracking** **Track Peak**. The reference level is now adjusted with each sweep so that the peak point on the measurement trace falls on the reference line. Note that the y-axis is now a relative scale, with all amplitude values referenced to the reference line.
3. To turn reference tracking off, press **SCALE** **Reference Tracking** **OFF**. The y-axis reverts to its previous scale format, and the reference level is readjusted so that the measurement trace is placed correctly on the display for absolute measurements.

To Track a Frequency

1. If you want to move the reference position (indicated by the ► symbol on the left side of the display), press **SCALE** **Reference Position** and then use the front panel knob, the   keys, or the numeric keypad to enter a new reference position. A number is assigned to each possible reference position. See [Figure 4-19](#).
2. Press **SCALE** **Reference Tracking** **Set Track Frequency** . Use the front panel knob, the   keys, or the numeric keypad to enter the frequency of interest.
3. Press **SCALE** **Reference Tracking** **Track Frequency** . The reference level is now adjusted with each sweep so that the frequency of interest falls on the reference line. Note that the y-axis is now a relative scale, with all amplitude values referenced to the reference line. Also note that a small arrow appears underneath the measurement trace at the point where the frequency of interest intersects the reference line.
4. To turn reference tracking off, press **SCALE** **Reference Tracking** **OFF** . The y-axis reverts to its previous scale format, and the reference level is readjusted so that the measurement trace is placed correctly on the display for absolute measurements.

Customizing the Display

The analyzer's display can be customized in several ways:

- You can choose to view one or both measurement channels using the split display feature.
- You can turn on or off features such as the display graticule and limit lines.
- You can also modify and/or turn on or off most of the display annotation.
- You can expand the measurement display to the full screen size and eliminate all annotation except marker annotation.

Refer to "Displaying Measurement Results" in the *Automating Measurements User's Guide Supplement* for more information on customizing the display.

Using the Split Display Feature

When using both measurement channels, you can choose to either view both of them simultaneously on one full-size display, or use the split screen feature.

To use the split display feature, press **DISPLAY** **More Display** **Split Disp FULL split**. Refer to [Figure 4-20](#).

Figure 4-20 Split Display

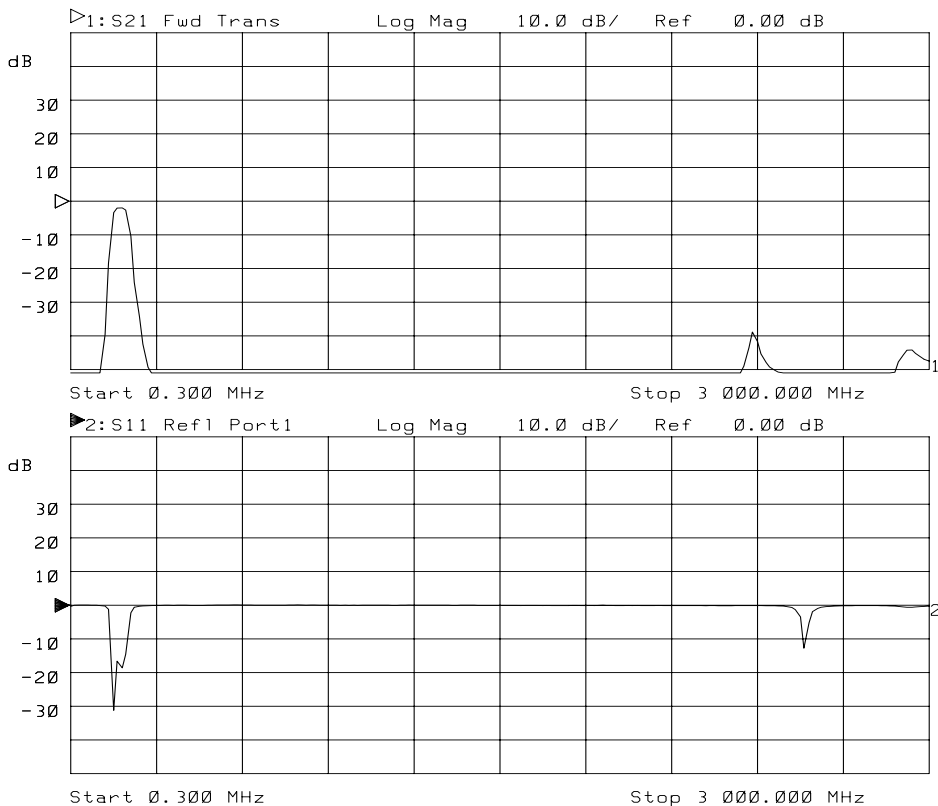

Enabling/Disabling Display Features

Figure 4-21 shows a display screen with graticule lines (the measurement grid), and two limit lines. In the default or preset state, these lines are turned on.

Figure 4-21 **Display Features**

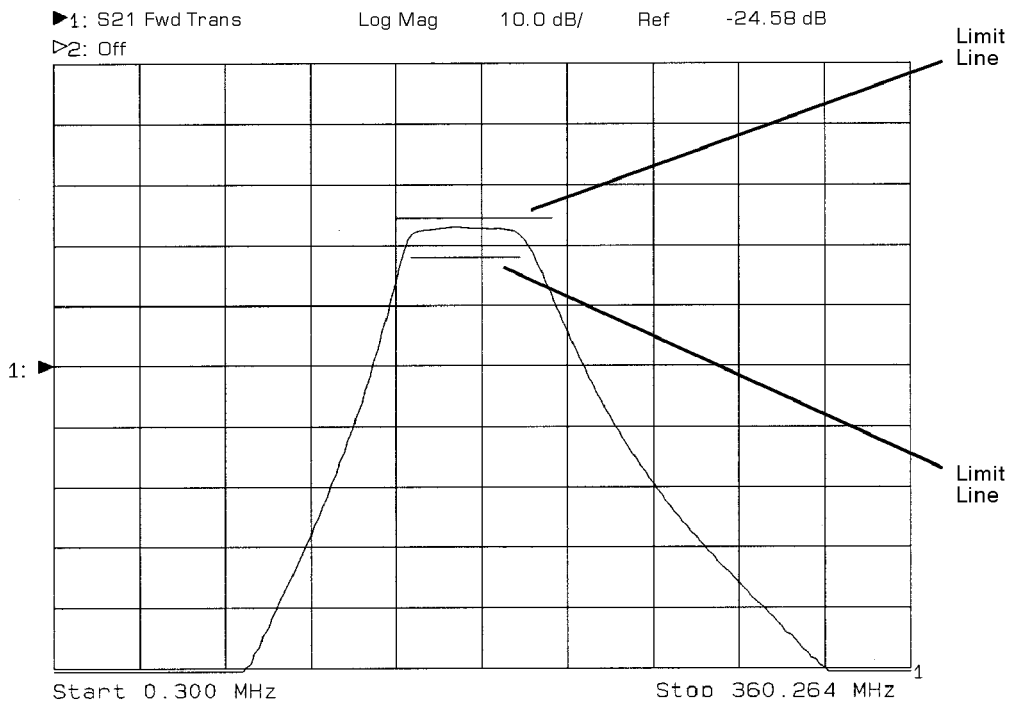

pp648es

1. To turn on/off the graticule, press **DISPLAY** **More Display** **Graticule ON off**. This softkey toggles the display graticule on and off.
2. To turn on/off the limit line or point, press **DISPLAY** **Limit Menu** **Limit Options** **Limit Line on OFF**. This softkey toggles the limit line or point on and off. Turning limit lines or points off does *not* turn limit testing off.

NOTE

You cannot turn off the delta amplitude or delta frequency limit indicators.

Modifying Display Annotation

When you first turn on your analyzer, or use the **PRESET** (**User Preset** or **Factory Preset**) keys to return it to the default condition, most of the display annotation is visible. You may want to modify or turn on or off some of the annotation to customize the display to your preferences. [Figure 4-22, “The Display Annotation,”](#) shows the display screen and points out the different annotation areas. Some of these areas can be modified, and all of them can be turned on or off.

Figure 4-22 **The Display Annotation**

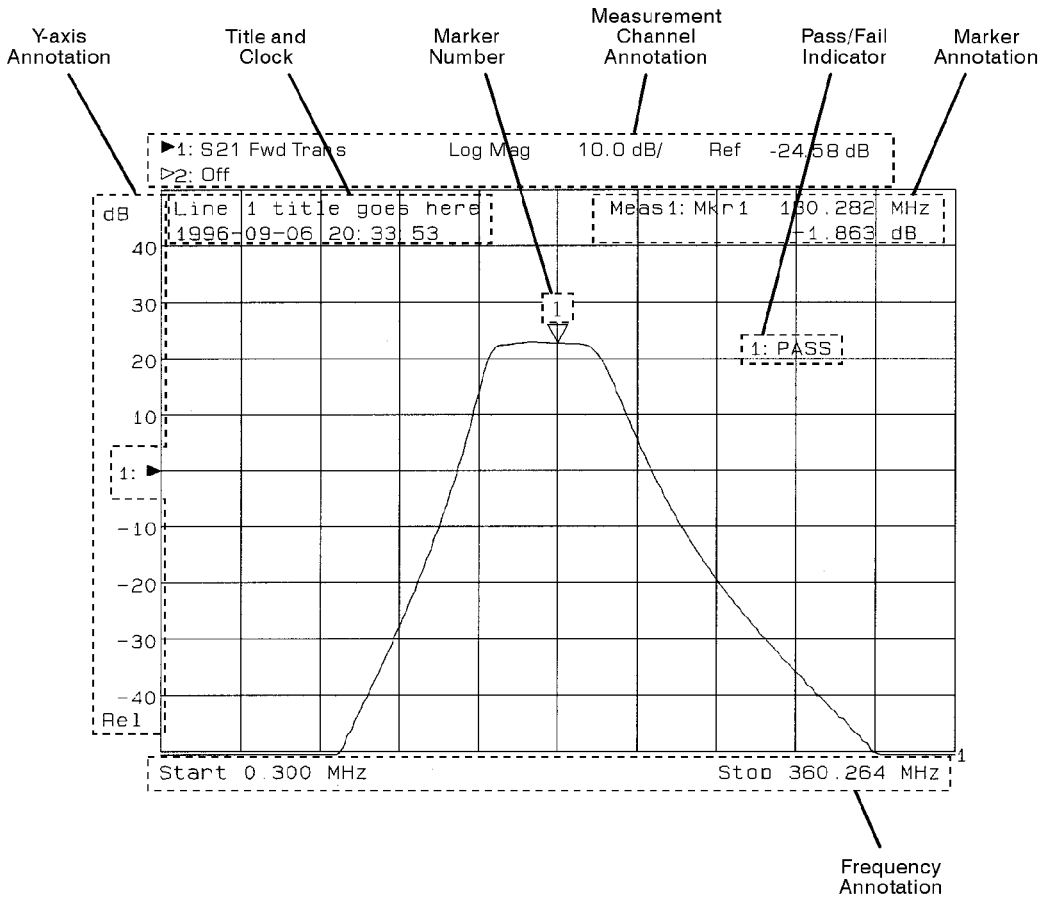

pp645es

Using Instrument Functions

Customizing the Display

The following display annotation areas can be modified or turned on or off:

- Measurement title and clock
- Measurement channel annotation
- Frequency annotation
- Marker annotation
- Marker number
- Y-axis labels
- Y-axis (relative or absolute scale)
- Limit test Pass/Fail text
- Limit icon
- Limit test Pass/Fail indicator position

Measurement Title and Clock

The measurement title area consists of two lines of text. In the default or preset state, this annotation area is toggled off. When the title mode is initially turned on—by pressing **DISPLAY** **More Display** **Title and Clock**—line 1 is empty and the clock (date and time of day) is assigned to line 2.

The **Title and Clock** menu allows you to customize these two lines. The clock can be shown on line 1, line 2, or can be turned off. You can enter up to 30 characters of text on either or both lines.

NOTE

When the display is in split display mode, line 1 is shown at the top of the measurement channel 1 screen, and line 2 is shown at the top of the measurement channel 2 screen.

To turn the measurement title and clock on or off, press **DISPLAY** **More Display** **Title and Clock** **Title+Clk ON off**.

- Measurement Channel Annotation** The measurement channel annotation at the top of the display screen can be modified through the use of SCPI commands. See the *Automating Measurements User's Guide Supplement* for more information.
- To turn the measurement channel annotation on or off, press **DISPLAY** **More Display** **Annotation Options** **Meas Annot ON off** .
- Frequency Annotation** The frequency annotation at the bottom of the display (X-axis) can be modified through the use of SCPI commands. See the *Automating Measurements User's Guide Supplement* for more information.
- To turn the measurement channel annotation on or off, press **DISPLAY** **More Display** **Annotation Options** **Freq Annot ON off** .
- Marker Annotation** The marker annotation that appears in the upper right corner of the display can be turned on or off by pressing **DISPLAY** **More Display** **Annotation Options** **Mkr Annot ON off** .
- Marker Number** The marker numbers that appear above or below the marker symbols, can be turned on or off by pressing **DISPLAY** **More Display** **Annotation Options** **Mkr Number ON off** .
- Y-Axis Annotation** Press **DISPLAY** **More Display** **Annotation Options** **Y-Axis Lbl rel ABS** to toggle the y-axis annotation and values: in ABS mode, the absolute value of each horizontal graticule line is indicated; in REL mode, the value of each horizontal graticule line is indicated relative to the value of the reference line.
- To turn on or off the y-axis annotation, press **DISPLAY** **More Display** **Annotation Options** **Y-Axis Lbl ON off** .
- Limit Test Pass/Fail Indicator** The limit test pass/fail indicator can be moved to any position on the display screen. To move the position of the pass/fail indicator, press **DISPLAY** **Limit Menu** **Limit Options** . Use the **Limit Icon X Position** and **Limit Icon Y Position** softkeys to position the pass/fail indicator where desired.
- To turn the pass/fail indicator text on or off, press **DISPLAY** **Limit Menu** **Limit Options** **Limit Text on OFF** .
- To enable or disable the display of the limit fail indicator, Δ , press **DISPLAY** **Limit Menu** **Limit Options** **Limit Icon on OFF** .

Expanding the Displayed Measurement

Normally, the displayed measurement is limited in size due to the softkey menu and the surrounding annotation. The expanded display feature removes these size-limiting factors, with the exception of annotation inside the normal graticule, and expands the display to the full screen size. The remaining annotation is enlarged for better readability.

To use the expanded display feature, follow the steps below.

1. Press **(DISPLAY)** **More Display** **Expand ON off**.
2. Press **(ENTER)**.

At this point, and until you turn the expand mode off with the **Expand on OFF** key, the **(ENTER)** key is used to toggle between the expanded display and the normal display.

NOTE

Because the **(ENTER)** key also functions as the “entry off” key, it may be necessary to press **(ENTER)** twice.

The following figures illustrate the difference between a normal display and an expanded display.

Figure 4-23 Normal Display

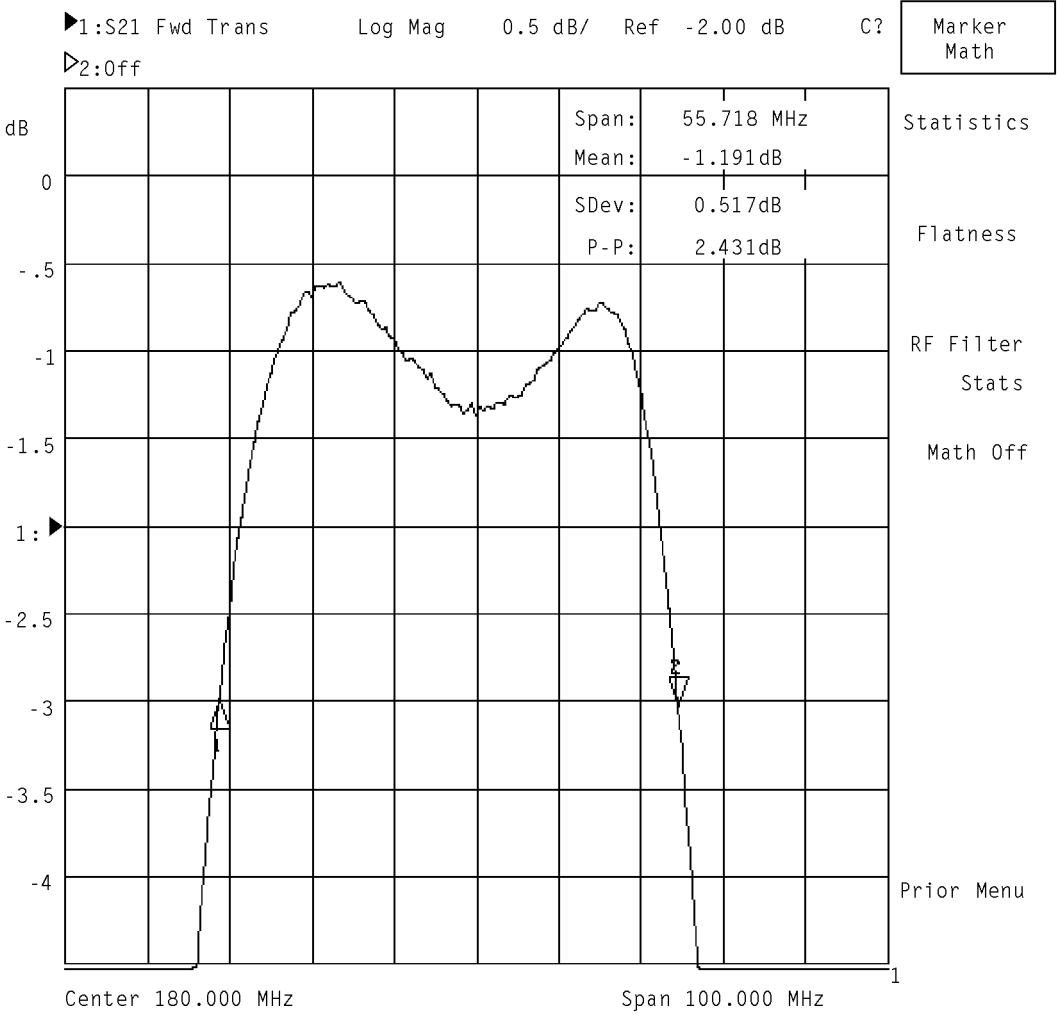

pp654es

Figure 4-24 **Expanded Display**

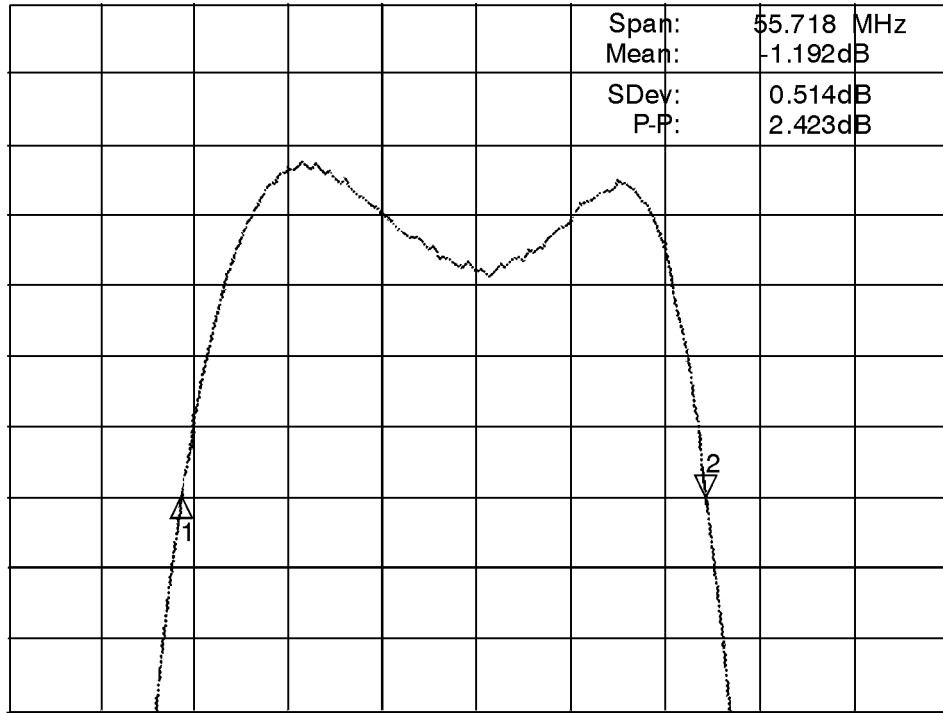

pp625c

Using Memory Traces

The analyzer has two available memory traces, one per channel. Memory traces are totally channel dependent: channel 1 cannot access the channel 2 memory trace or vice versa. Memory traces can be saved with instrument states: one memory trace can be stored per channel for each saved instrument state. The memory data is stored as full precision, complex data.

IMPORTANT

A memory trace must be displayed in order to be saved with an instrument state. If a memory trace is not displayed, it won't be saved with the instrument state. When an instrument state that doesn't include a memory trace is recalled, any previously existing memory trace will remain.

To Store a Data Trace to the Display Memory

Press **(DISPLAY) Data->Mem** to store the current active measurement data in the memory of the active channel. The data trace is now also the memory trace. You can use the memory trace for subsequent data/memory operations.

To View the Measurement Data and Memory Trace

The analyzer default setting shows you the current measurement data for the active channel.

1. To view a data trace that you have already stored to the active channel memory, press **(DISPLAY) Memory** .
2. To view both the memory trace and the current measurement data trace, press **(DISPLAY) Data and Memory** .

To Divide Measurement Data by the Memory Trace

You can use this feature for ratio comparison of two traces, for example, measurements of gain or attenuation.

1. You must have already stored a data trace to the active channel memory, as described in [“To Store a Data Trace to the Display Memory”](#) on page 4-55.
2. To divide the data by the memory, press **DISPLAY** **Data/ Mem** . The analyzer normalizes the data to the memory, and shows the results.

NOTE

The normalize function will automatically store a trace to memory and divide the current measurement data trace by the memory. Refer to [“To Perform a Normalization Calibration”](#) on page 6-14.

Saving and Recalling Measurement Results

The network analyzer allows you to save the following information to internal memory or to a DOS-formatted 3.5" floppy disk in the analyzer's built-in disk drive:

Instrument State

Instrument state settings consist of all the stimulus and response parameters that set up the analyzer to make a specific measurement including markers, limit lines, memory traces¹, and user-defined calibration kits. (For a list of all the parameters that are saved, view the seven screens displayed under the **Operating Parameters** key.) Instrument state information is saved and recalled for both measurement channels.

Cal

The measurement calibration information is the measurement correction data that the analyzer creates when you make a calibration. Measurement calibration information is saved and recalled for both measurement channels.

Data

The measurement data consists of the actual measurement data trace.

You can save any combination of the above three and recall them to be displayed on the network analyzer. You can also dump the measurement channel data to an ASCII format file that you can use for graphing and manipulation in spreadsheets and CAE programs.

NOTE

The **Cal on OFF** key is toggled OFF by default. When this key is toggled ON, calibration information is automatically saved, along with the instrument state settings.

1. Memory traces are not always stored with the instrument state. Refer to [“Using Memory Traces” on page 4-55](#).

NOTE

**Special Note for Owners of Older Model Analyzers
(HP/Agilent 8711A, 8711B/12B/13B/14B, 8711C/12C/13C/14C)**

If you own one of these older model analyzers, there are some compatibility issues you should be aware of:

- The "A" and "B" model analyzers allowed you to save to a LIF formatted floppy disk. The "C" and the "E" model analyzers with Firmware Revision E.05.XX allow you to read from a LIF disk, but you cannot save to a LIF disk. The current "E" model analyzers, with Firmware Revision E.06.00 or later, will not read from or write to a LIF disk.
 - The file format for the "A" and "B" model analyzers is different from the "C" and the "E" model format. When saving data, you can save it either in a format that is compatible with older analyzers (**8711A/B Compatible**), (**8711C Compatible**), or in a format that is only compatible with "E" analyzers (**8712E Compatible**). See ["Define and Save Data" on page 4-60](#) for more information.
-

Saving Instrument Data

When you save data to a file, the analyzer automatically selects a file name for you. Since these names may not be as descriptive as desirable, you may change the name of the file after it has been saved, or you can save it to a file name of your choice by using the **Re-Save State** function. See “[Other File Utilities](#)” on page 4-65 for information on how to change a file name. When saving a file using the **Re-Save State** function, enter the file name in one of the following ways:

- Use an external keyboard connected to the analyzer's rear panel DIN KEYBOARD connector and type in the filename. (For information on using a keyboard, see “[Using a Keyboard](#)” on page 4-85.)
- Press **(SAVE RECALL) Re-Save State**. Use the front panel knob and **Select Char** key to point and select each character of the new filename. Then press **Enter**.

NOTE

Refer to [Chapter 11, “Factory Preset State and Memory Allocation,”](#) for information on the analyzer's instrument state memory allocation.

Select the Disk

1. Press **(SAVE RECALL) Select Disk**, and press the key that corresponds to the disk where you are going to save data:
 - Press **Non-Vol RAM Disk** to save to the analyzer's internal non-volatile memory. (Non-volatile means that the information will be retained in memory when the power to the analyzer is turned off.) This is the default selection.
 - Press **Volatile RAM Disk** to save to the analyzer's internal volatile memory. (Volatile means that the information will be lost if power to the analyzer is turned off.)
 - You can configure the volatile RAM disk by pressing the **Configure VOL_RAM** softkey.
 - When this key is pressed, a message appears displaying the current percentage allocation between RAM disk and IBASIC memory.
 - To change the memory allocation, press **Modify Size**, then enter the new RAM disk allocation.
 - The power must be cycled on the analyzer for the changes in memory allocation to take effect.

- Press **Internal 3.5" Disk** to save to the 3.5" disk in the analyzer's built-in disk drive. Only MS-DOS format disks can be used. If your disk is not formatted, refer to the procedure in "Formatting a Floppy Disk" on page 4-69.

Define and Save Data

1. Press **Prior Menu Define Save** .
 - Toggle **Inst State** to OFF if you *do not* want the instrument state saved. (This will save measurement data only.)
 - Toggle **Cal** to ON if you want to save the active measurement calibration.
 - Toggle **Data** to ON if you want to save the measurement data that is displayed on the network analyzer screen.

NOTE

Note that the **Inst State** key is automatically toggled ON when the **Cal** key is toggled ON.

2. Press **Prior Menu Save State** to save the instrument state file. The filename appears on the screen as STATE#.STA (where # is a number the analyzer selects from 0 to 999).
3. If you own older model network analyzers (8711A, 8711B/12B/13B/14B, 8711C/12C/13C/14C), and you need your saved files to be recalled on any of these older model analyzers, select **File Format** , **8711A/B Compatible** or **8711C Compatible** .
4. If you do not need your files to be compatible with older model analyzers, always choose **File Format** **8712E Compatible** . This is the default format.

NOTE

Recalling an instrument state will not change the value of the System Z0.

To Save Measurement Data in ASCII Format

Your measurement data can be saved in an ASCII format that is compatible with many personal computer software packages.

To save the measurement trace as an ASCII file:

1. Press **SAVE RECALL** **Select Disk** , and select the softkey that corresponds to where you want to save your file. (See [“Select the Disk” on page 4-59.](#))
2. Press **Prior Menu** **Define Save** **Save ASCII** .
 - a. Choose **Lotus 123 Format** or **Touchstone Format** .
 - **Lotus®1-2-3®** format is a two-column format that is compatible with many personal computer software packages. Column 1 is the frequency point, and column 2 is the measured value at that point.
 - **Touchstone** format (also called S2P data format) is useful for importing measurement data into CAE programs such as Agilent Technologies' Microwave Design System (MDS) and Advanced Design System (ADS).
 - b. Choose **Save Meas 1** or **Save Meas 2** , depending on which measurement channel data you want to save.
3. The filename appears on the network analyzer screen as TRACE# . PRN (for Lotus 1-2-3 files) or TRACE# . S1P (for Touchstone files), where # is a number the analyzer selects from 0 to 999.

NOTE

Your analyzer can store files only on floppy disks that are formatted in MS-DOS.

To Recall from a Floppy Disk or Internal Memory

The network analyzer allows you to recall and display measurement results that you saved as `STATE` files. You can then compare the recalled measurements to subsequent measurements. The analyzer can display both a data and memory trace for each measurement channel. The data trace is saved when you select **Data ON** in the **Define Save** menu. The memory trace is saved as part of the instrument state. These traces will be automatically re-displayed when you recall the file from a floppy disk or internal memory.

Measurement calibration information is linked to the instrument state and measurement parameters for which the calibration was done. Therefore, a saved calibration can be used for multiple instrument states as long as the measurement parameter, frequency range, and number of points are compatible. For more information, refer to [Chapter 6, “Calibrating for Increased Measurement Accuracy.”](#)

1. Press **(SAVE RECALL)** **Select Disk** and press the key that corresponds to the location where your desired file exists.
2. If necessary, change directories to the directory that contains the desired file as described in [“To Use Directory Utilities” on page 4-67](#).
3. Press **Prior Menu** and turn the front panel knob to move the highlighted bar to the file you want to recall.
4. Press **Recall State** to recall the desired file to the network analyzer.

Using Fast Recall with the Front Panel or a Keyboard

The fast recall feature allows you to recall an instrument state with just 1 or 2 key presses, *or* to cycle through up to seven different instrument states with a foot switch or hand switch.

1. Press **SAVE RECALL**.
2. If the measurement display area changes to a listing of files on the currently selected disk, fast recall is off.

If the measurement display area remains unchanged, fast recall is on. To follow along with this explanation, turn fast recall off by pressing the **Fast Recall ON off** softkey.

3. If necessary, select the internal non-volatile RAM disk by pressing **Select Disk Non-Vol RAM Disk**.
4. If you have previously saved any files to this disk, they will now be listed on the display.
5. The fast recall feature utilizes only the first seven files listed that contain instrument state, calibration, or measurement data.
6. If you have not previously saved any files to this disk, you may want to save a few instrument states now, to follow along.
7. Press **Prior Menu FastRecall on OFF**. Note that the measurement display now reappears on the screen and that there are file names next to the first seven softkeys. (If any of the softkeys are blank, it's because you had less than seven files saved on the disk.)

The files are placed on the softkeys in the order in which they appear in the disk's directory table.

NOTE

You may want to use the **Rename File** feature to give your files more meaningful names. See [“Other File Utilities” on page 4-65](#) for information on renaming files.

8. To "fast recall" an instrument state, press the softkey next to the file that contains the instrument state.
9. The fast recall toggle will remain on (even when the analyzer is **PRESET**) until manually turned off.
10. With the fast recall feature turned on, you will always be only 1 or 2 key presses away from recalling an instrument state.

11. With an external keyboard connected to the rear panel DIN connector, keys F1 through F7 are equivalent to pressing softkeys 1 through 7 on the analyzer. See “Using a Keyboard” on page 4-85 for information on connecting and using an external keyboard.

Using Fast Recall with a Switch

When fast recall is used in conjunction with a switch connected to the USER TTL IN/OUT rear panel connector, you can cycle through up to seven instrument states in sequence by activating the switch.

1. Connect a switch to the USER TTL IN/OUT rear panel connector as shown in Figure 4-25.

Figure 4-25 Connect a Switch to the USER TTL IN/OUT Connector

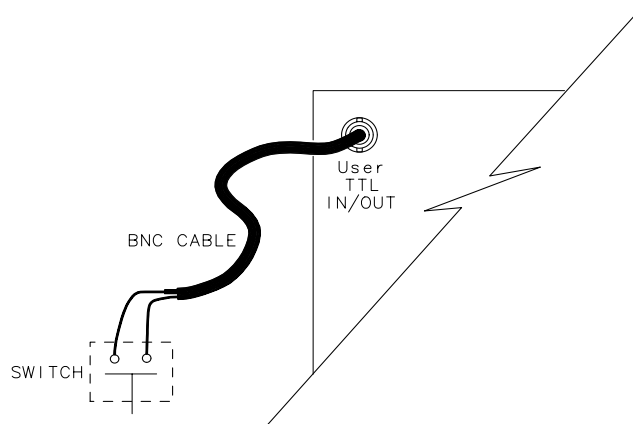

po699b



2. Make sure the analyzer is configured to use the USER TTL IN/OUT connector for softkey sequencing: press **SYSTEM OPTIONS** **System Config** **User TTL Config** **Softkey Auto-Step**.
3. With fast recall toggled to on, press the switch several times while observing the analyzer.
4. Notice that with each press of the switch, the files are highlighted (boxed) in succession, and that after the last available file has been used, the sequence starts again at the top of the softkey menu.

Other File Utilities



To Rename a File

1. Press **SAVE RECALL** **Select Disk** and press the key that corresponds to the disk where the desired file is located.
2. Use the front panel knob to move the highlighted bar to the file you want to rename.
3. Press **Prior Menu** **File Utilities** **Rename File** .
4. Use the **Backspace** key repeatedly, or press **Clear Entry** to erase the current filename from the analyzer screen.
5. Enter the new filename in one of the following ways:
 - Use an external keyboard connected to the analyzer's rear panel DIN KEYBOARD connector and type in the new filename. (For information on using a keyboard, see [“Using a Keyboard” on page 4-85.](#))
 - Use the front panel knob and **Select Char** key to point and select each character of the new filename. Then press **Enter** .

To Delete a File

1. Highlight the file to be deleted by using the front panel knob or the   keys.
2. Press **Delete File** **YES** .
3. To delete all files within the current directory, press **Delete All Files** **YES** .

To Copy a File

1. Highlight the file to be copied by using the front panel knob or the   keys.
2. Press **Copy File** and then select the destination disk for the file to be copied. You will then be given the opportunity to edit the destination file name if you wish.
3. Use a keyboard (if connected) or the front panel knob and the softkeys to enter the destination filename.

CAUTION

There will be no warning from the analyzer if the destination file already exists. It will be overwritten without warning. For instance, STATE1 . STA on the internal memory disk and STATE1 . STA on a floppy disk in the built-in disk drive may contain completely different sets of data. If you copy one of those files to the other without editing the file name, the destination file will be overwritten with the source file.

4. To copy the file, press **Enter** .
5. To copy all the files in the current directory, press **Copy All Files** and then select the destination disk for the files to be copied.
6. You will then be prompted to tell the analyzer where on the destination disk to put the files to be copied.
7. Press **Enter** if you want the files to go into the main, or root, directory of the destination disk. Use a keyboard (if connected) or the front panel knob and the softkeys to enter a subdirectory on the destination disk before pressing **Enter** .

To Access Files from SCPI, IBASIC, or FTP

Files on each disk can be accessed via GPIB using SCPI commands, directly from IBASIC, or over a LAN. The table below shows the names used for each disk. You will notice that when using the file utilities, the analyzer displays the SCPI name in the disk catalog window and in the filename entry windows.

NOTE

The dynamic data disk is an internal FTP directory called "data." For more information, refer to "Accessing the Analyzer's Dynamic Data Disk," located in *The LAN Interface User's Guide Supplement*.

Table 4-1 Disk Access

Disk	SCPI name	IBASIC name	FTP directory
Non-Volatile RAM Disk	MEM: <i>file</i>	<i>file</i> : MEMORY , 0 , 0	/nvram/ <i>file</i>
Volatile RAM Disk	RAM: <i>file</i>	<i>file</i> : MEMORY , 0 , 1	/ram/ <i>file</i>
Internal 3.5" Disk	INT: <i>file</i>	<i>file</i> : INTERNAL	/int/ <i>file</i>
Dynamic Data Disk	DATA: <i>file</i>	not supported	/data/ <i>file</i>
NFS Mounted Disk	(<i>NFS local path</i>)	not supported	not supported

- For more details on GPIB programming, refer to the *Programmer's Guide* and the *Example Programs Guide*.
- For more details on IBASIC disk access, refer to the IBASIC "MASS STORAGE IS" keyword in the *HP Instrument Basic User's Handbook*.
- For more details on FTP disk access via LAN, refer to *The LAN Interface User's Guide Supplement*.

To Use Directory Utilities

This section describes how to make directories so you can store files into categories, how to change between the various existing directories, and how to remove an unwanted directory. You can make directories for the analyzer's internal non-volatile RAM disk, the internal volatile RAM disk, and the 3.5" floppy disks used in the analyzer's built-in disk drive.

Make a Directory

1. If you are going to use a floppy disk, place an MS-DOS formatted disk in the analyzer's built-in disk drive. If your disk is not formatted, refer to ["Formatting a Floppy Disk" on page 4-69](#).
2. Press **SAVE RECALL** **Select Disk** .
3. Choose the location of the disk you want to make the directory on: internal non-volatile RAM disk, internal volatile RAM disk, or internal 3.5" disk (floppy disk used in the analyzer's built-in disk drive).

CAUTION

Remember that volatile RAM disk memory *will* be lost if the power to the instrument is turned off.

4. Press **Prior Menu** **File Utilities** **Directory Utilities** **Make Directory** .

Think of a logical name to call a directory. Standard MS-DOS naming conventions apply to the name of the directory (maximum of eight characters plus a three character extension).



Windows 95®, Windows 98®, and Windows NT® extended file names are *not* supported.

5. Enter the name of the new directory in one of the following ways:
 - Use an external keyboard connected to the analyzer's rear panel DIN KEYBOARD connector and type in the new filename. (For information on using a keyboard, see ["Using a Keyboard" on page 4-85](#).)
 - Use the front panel knob and **Select Char** key to point to and select each character of the new directory name. Then press **Enter** .
6. Press **Make Directory** to create the directory.



NOTE

You can also change to a directory and use **Make Directory** to create a subdirectory. The number of characters in a directory and subdirectory path cannot exceed the MS-DOS limitation of 63.

Change to a Directory

1. Press the   keys to highlight the directory you want to change to. Then press **Change Directory**. After changing directories, the current directory name appears in the top box of the displayed table.
2. To change to the previous directory, highlight **..<PARENT>** and press **Change Directory** to return to the disk's previous directory.
3. To change to the disk's main or root directory, continue highlighting and changing to the **..<PARENT>** directory until the current directory name in the top box is simply a backslash "\."

Remove a Directory

1. A directory must be empty before it can be removed. If there are files in the directory that you want to move elsewhere and delete, refer to ["Other File Utilities" on page 4-65](#) for information on how to copy and delete files.
2. Highlight the directory to be removed by using the front panel knob or the   keys.
3. Press **Remove Directory**.

Formatting a Floppy Disk

Unformatted floppy disks must be formatted before you can save data on them. The analyzer's internal non-volatile RAM disk and internal volatile RAM disk do not need to be formatted.

CAUTION

All information on the disk will be erased during the formatting process.

1. Make sure the disk is not write protected by ensuring the write protect tab is in the proper position.
2. Insert the disk into the analyzer's disk drive.
3. Press **(SAVE RECALL) File Utilities Format Disk Menu Format 3.5" Disk YES**.
4. It will take approximately 2.5 minutes for the disk to be formatted.

Connecting and Configuring Printers and Plotters

The analyzer is capable of plotting or printing displayed measurement results directly (without the use of an external computer) to a compatible peripheral. The analyzer supports GPIB, serial, parallel, and LAN peripherals.

NOTE

Hardcopy device selection and configuration parameters are retained when the analyzer is turned off or is preset.

Select a Compatible Plotter or Printer

Most Hewlett-Packard plotters and desktop printers are compatible with the analyzer. Some common compatible plotters are listed below (some are no longer available for purchase but are listed here for your reference). Also listed below is the address of an Agilent Web page that displays a current printer compatibility guide.

Compatible Plotters

- HP 7440A ColorPro Eight-Pen Color Graphics Plotter
- HP 7470A Two-Pen Graphics Plotter
- HP 7475A Six-Pen Graphics Plotter
- HP 7550A/B High-Speed Eight-Pen Graphics Plotter

Compatible Printers

For a current printer compatibility guide, consult the Agilent Web page at <http://www.agilent.com/find/pcg> or contact the nearest Agilent Technologies sales or service office. Refer to [Table 9-10 on page 9-59](#) for the nearest office.

Select an Appropriate Interface Cable

If your peripheral is to be connected to GPIB, choose one of the following Agilent cables:

- 10833A GPIB Cable, 1.0 m
- 10833B GPIB Cable, 2.0 m
- 10833D GPIB Cable, 0.5 m

If your peripheral is to be connected via the parallel or serial port on the analyzer, choose from the following recommended cables:

- HP C2950A Parallel Interface Cable, 2.0 m
- HP C2951A Parallel Interface Cable, 3.0 m
- HP C2946A Parallel Printer Cable, 3.0 m
- HP C2947A Parallel Printer Cable, 10.m
- HP C2913A RS-232C (Serial) Interface Cable, 1.2 m
- HP 24542G Serial Interface Cable, 3 m (9F to 25M)

If your peripheral is to be connected via the LAN port on the analyzer, you will need a LAN hub and 2 Ethertwist cables. Choose from the following:

- HP J2610B AdvanceStack 10Base-T Hub-8U (typical 8-port hub)
- HP J2611B AdvanceStack 10Base-T Hub-16U (typical 16-port hub)
- 92268A Twisted-pair "straight-through" cable, 4 m
- 92268B Twisted-pair "straight-through" cable, 8 m
- 92268C Twisted-pair "straight-through" cable, 16 m
- 92268D Twisted-pair "straight-through" cable, 32 m
- 92268N Twisted-pair "straight-through" cable, 300 m

Connect the Printer or Plotter

1. Turn off the analyzer and the printer or plotter.
2. Connect to one of the ports shown in [Figure 4-26](#).

Figure 4-26 **Peripheral Connections**

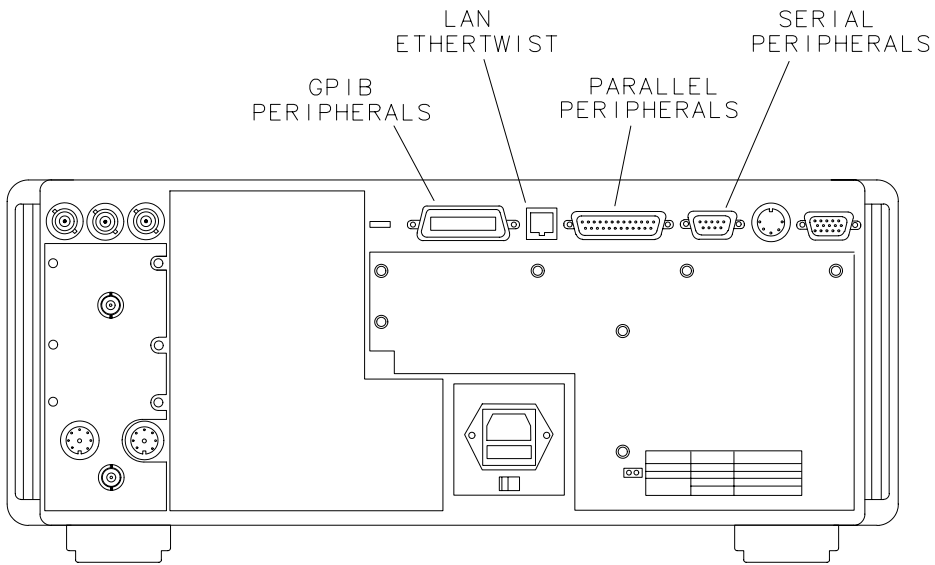

pp66c

Configure the Hardcopy Port

You will only have to do this setup once if you make all your hardcopies with the same printing or plotting device. You can configure the analyzer for any of the peripherals listed below:

DEVICE TYPE	LANGUAGE	HARDCOPY PORT
HP Plotter	HPGL	Parallel Port
HP Plotter	HPGL	RS232 Serial
HP Plotter	HPGL	GPIB
HP Printer	PCL	Parallel Port
HP Printer	PCL	RS232 Serial
HP Printer	PCL	GPIB
Epson Compatible	Epson	Parallel Port
Epson Compatible	Epson	RS232 Serial
File	HPGL	Internal 3.5" Disk
File	PCX	Internal 3.5" Disk
File	PCL5	Internal 3.5" Disk
File	HPGL	Non-Vol RAM Disk
File	PCX	Non-Vol RAM Disk
File	PCL5	Non-Vol RAM Disk
HP LaserJet PCL5/6	PCL5	Parallel Port
HP LaserJet PCL5/6	PCL5	RS232 Serial
HP LaserJet PCL5/6	PCL5	GPIB
HP LaserJet PCL5/6	PCL5	LAN

The analyzer can send print commands in PCL5, PCL, Epson, or HP-GL languages. Recommended usages are:

- Use PCL5 mode for maximum speed, if your printer supports it. HP LaserJet III/4/5 models support PCL5. Typical time to generate and send hardcopy output to a PCL5 printer is 1 to 10 seconds. (Most DeskJet printers do not support PCL5.)
- Use PCL or Epson language if your printer does not support PCL5. The analyzer uses Epson ESC P1 commands that are common to IBM mode devices and FX-86e/FX-800 mode Epson compatible devices.
- Use HP-GL language for plotters.

Selecting a Device Press **HARDCOPY** **Select Copy Port** and turn the front panel knob to move the highlighted bar to your printing or plotting device, then press **Select** .

Configuring the Analyzer for GPIB Devices If your GPIB printing/plotting device has a different address than the analyzer default of 05, press **Print/Plot GPIB Addr** and enter the address of your printing/plotting device (typical factory defaults: printer = 01, plotter = 05). Use the front panel numeric key pad to make your entry.

Configuring the Analyzer for a LAN Printer Press **LAN Printr IP Addr** . Use an external keyboard connected to the analyzer's rear panel DIN KEYBOARD connector and type in the LAN IP address. (For information on using a keyboard, see [“Using a Keyboard” on page 4-85.](#)) Or, use the front panel knob and **Select Char** key to point to and select each character of the IP address. Then press **Enter** . Refer to *The LAN Interface User's Guide Supplement* for information on using the LAN connection for printing.

Configuring the Analyzer for RS-232 Devices

1. If the baud rate of your printing/plotting device is different than the factory default (19200), press **Baud Rate** and enter the baud rate of your printing/plotting device. (Refer to your printer or plotter manual for the baud rate of your device.) You can set the baud rate to 1200, 2400, 4800, 9600, 19200, 38400, 57600, or 115200 baud. If you are sending graphics to the hardcopy device, the fastest supported baud rate is recommended.
2. Choose between Xon/Xoff which specifies a software handshake (this is the default), and DTR/DSR which specifies a hardware handshake.

Define the Printer or Plotter Settings

You will only have to do this setup once if you make all your hardcopies with the same printing or plotting device.

Press **(HARDCOPY)**, and then **Define PCL5**, **Define Printer**, or **Define Plotter**, depending on which type of device you are using. Note that only one of these choices is selectable at a time.

Three procedures follow. Use “[Defining a PCL5 Printer](#),” below, or “[Defining a Printer](#)” on page 4-77 if you are using a printer. Otherwise, go to “[Defining a Plotter](#)” on page 4-79.

Defining a PCL5 Printer

Make the following selections in the analyzer menus:

1. Press **Restore Defaults** to restore the default parameters for a printer. The defaults are:

Parameter	Default
Monochrome/Color	Monochrome
Orientation	Portrait
Auto Feed	ON
Top Margin	0.00 mm
Left Margin	0.00 mm
Print Width	150 mm (5.91 in)

2. Select the type of printer you have: either **Monochrome** or **Color**.
3. Select the orientation of the paper to the information printed, either **Portrait** or **Landscape**. The portrait choice orientates the printout vertically, the landscape orientates the printout horizontally.
4. If you do *not* want auto feed active, press **Auto Feed OFF**.
5. Press **More PCL5** to change the margins and print width:
 - a. **Top Margin**: Sets the top margin (non-printing space) of the printout in mm. Minimum setting is 0.00 mm; maximum setting is 200.00 mm.
 - b. **Left Margin**: Sets the left margin (non-printing space) of the printout in mm. Minimum setting is 0.00 mm; maximum setting is 200.00 mm.
 - c. **Print Width**: Sets print width (printing space) of printout in mm. Minimum setting is 80 mm; maximum is 500 mm. Width is defined relative to the printer. It is the dimension at right angle to the travel of the paper. Landscape mode is rotated one-quarter turn relative to portrait mode. Thus, in landscape mode, print width actually defines the height of the printed image.

NOTE

PCL5 "PRINT OVERRUN" Errors and Page Protection

When printing using PCL5 format, the printed page's complexity may exceed the printer's ability to create the image and keep pace with the engine printing process. If the data is too complex, it might print in sections, or only part of the page might print—some print data loss is likely. In such cases, a "PRINT OVERRUN" message appears in the printer's display.

To solve this problem, some printers have a feature called "Page Protection" which reserves printer memory for the page image process, allowing the printer to create the entire page in memory before physically moving the paper through the printer. This process ensures that the entire page will be printed.

Enable the page protection feature by consulting your printer manual. **Note:** some printers require 2 MB of memory, or more, to support this page protection feature.

Defining a Printer Make the following selections in the analyzer menus:

1. Press **Restore Defaults** to restore the default parameters for a printer. The defaults are:

Parameter	Default
Monochrome/Color	Monochrome
Orientation	Portrait
Auto Feed	ON
Printer Resolution	96 Dots Per Inch
Top Margin	0.00 mm
Left Margin	0.00 mm
Print Width	150 mm (5.91 in)

2. Select the type of printer you have: either **Monochrome** or **Color**.
3. Select the orientation of the paper to the information printed, either **Portrait** or **Landscape**. The portrait choice orientates the printout vertically, the landscape orientates the printout horizontally.
4. If you do *not* want auto feed active, press **Auto Feed OFF**.
5. Press **More Printer** to change the printer resolution, margins, and print width:
 - a. **Printer Resolution**: Refer to the following table for some specific printers and their valid print resolutions.

Using Instrument Functions
Connecting and Configuring Printers and Plotters

Printer	Valid Resolutions (in DPI)
HP ThinkJet	96
HP PaintJet	90, 180
HP LaserJet	75, 100, 150, 300, 600
HP DeskJet ^a	75, 100, 150, 300, 600
HP QuietJet	96, 192
Epson	60, 120, 240, 360

- a. HP DeskJet 540 should not be used at 100 dpi.
- b. **Top Margin** : Sets the top margin (non-printing space) of the printout in mm. Minimum setting is 0.00 mm; maximum setting is 200.00 mm.
- c. **Left Margin** : Sets the left margin (non-printing space) of the printout in mm. Minimum setting is 0.00 mm; maximum setting is 200.00 mm.
- d. **Print Width** : Sets print width (printing space) of printout in mm. Minimum setting is 80 mm; maximum is 500 mm. Width is defined relative to the printer. It is the dimension at right angle to the travel of the paper. Landscape mode is rotated one-quarter turn relative to portrait mode. Thus, in landscape mode, print width actually defines the height of the printed image.

Defining a Plotter Make the following selections in the analyzer menus:

1. Press **Restore Defaults** to restore the default parameters for a plotter. The defaults are:

Parameter	Default
Monochrome/Color	Monochrome
Auto Feed	ON
Color Plotter Pen Numbers	Trace 1 = Pen 1 Trace 2 = Pen 2 Memory 1 = Pen3 Memory 2 = Pen 4 Graticule = Pen 5 Graphics = Pen 6



2. Select the type of plotter you have: either monochrome or color.
3. Use **Set Pen Numbers** to select the pen number(s) for the data traces, memory traces, graticule, and graphics. Press **Prior Menu** when done selecting pens.
4. If you do *not* want auto feed active, press **Auto Feed OFF** .

Printing and Plotting Measurement Results

To print or plot measurement results, perform the following steps:

1. Select the appropriate copy port:
 - Printer *or*
 - Plotter *or*
 - File
2. Define the output
3. Generate the output:
 - Hardcopy *or*
 - Plot to file

To Select the Copy Port

Press **HARDCOPY** **Select Copy Port**. Use the front panel knob or the   keys to move the highlighted bar to the appropriate device type/language/hardcopy port. If you select a printer or plotter, refer to [“Connect the Printer or Plotter” on page 4-72](#). When you select a file, you must select whether to store it on the analyzer's non-volatile RAM disk or a 3.5” floppy disk in the built-in disk drive. Also, you must select either an HP-GL, PCL5, or PCX file format. All of these formats can be imported to many personal computer (PC) applications such as word processors and drawing programs. This allows a simple method for screen dumps to be used in reports, memos, or other communications. In addition, with the LAN feature, you can use FTP to directly get a hardcopy file in either HP-GL, GIF, or PCX format. See *The LAN Interface User's Guide Supplement* for information.

NOTE

If you are sending hardcopy to an external device (printer or plotter), you should have already configured the analyzer for use with the printer or plotter. See the previous section, [“Connect the Printer or Plotter”](#) for more information.

To Define the Output

The first step in defining the output is deciding which hardcopy components you want in your printout, plot, or file.

To select your choice of format, press **HARDCOPY**

Define Hardcopy and then one of the following selections. [Figure 4-27](#), “Hardcopy Components and Formats Available,” and [Figure 4-28](#), “Trace Values,” show the available hardcopy components and formats.

- | | |
|----------------------------|--|
| Graph and Mkr Table | outputs both the graph and marker table. |
| Graph Only | outputs only the graph. (This selection allows printing of the limit-line table as well.) |
| Mkr Table Only | outputs only the marker table. (This selection allows printing of the limit-line table as well.) |

Figure 4-27 Hardcopy Components and Formats Available

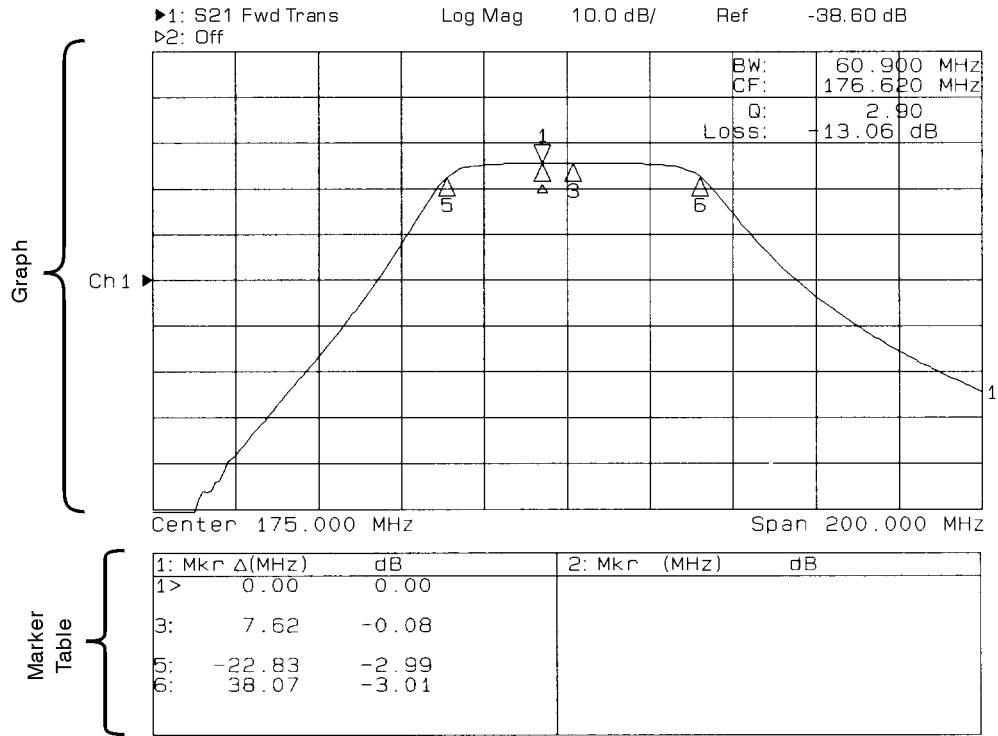

pp646es

List Trace Values outputs only the marker table. (This selection allows printing of the limit-line table as well.)

Figure 4-28

Trace Values

Trace Values		
CHANNEL 1: S21 Fwd Trans		
FREQ(MHz)	dB	Mkr#
0.300	-47.01	
2.047	-66.92	
3.794	-71.87	
5.541	-76.94	
7.288	-82.18	
9.035	-89.23	
10.782	-77.77	
12.529	-82.95	
14.276	-89.84	
16.023	-85.46	
17.770	-79.86	
19.517	-88.07	
21.264	-80.75	
23.011	-83.53	
24.758	-87.51	
26.505	-84.91	
28.252	-83.51	
29.999	-86.01	

pp647es

NOTE

Figure 4-28 shows the trace values for a transmission measurement in log mag format. Trace values for polar format will be frequency, magnitude, and phase; while trace values for Smith chart format will be frequency, resistance, and complex impedance.

NOTE

You may notice a decrease in measurement speed when the network analyzer is outputting to a printer or plotter that doesn't have a built-in buffer. For the fastest possible hardcopy dump to such devices, press **MENU** **Trigger** **Hold** before beginning the print or plot. Refer to the following table for some typical print times.

NOTE

The following table provides some typical print times for various HP printers. These values are typical only; they are not intended to necessarily represent the print times you will experience. They are provided for comparison only. In addition, the number of measurement points, measurement trace complexity, number of traces, user graphics, continuous sweep, and print size and format are among the many parameters that can have an affect on your particular print time.

Table 4-2 Typical Print Times

Printer Resolution (dpi) ^a	Portrait Format (min:sec)						Landscape Format (min:sec)					
	Desk-Jet 400	Desk-Jet 693C	Desk-Jet 890C	Desk-Jet 1200C ^b	Desk-Jet 1600C	Laser-Jet 6L	Desk-Jet 400	Desk-Jet 693C	Desk-Jet 890C	Desk-Jet 1200C ^b	Desk-Jet 1600C	Laser-Jet 6L
MONO^c												
100	0:43	0:37	0:19	0:18	0:26	0:27	0:50	0:48	0:24	0:21	0:52	0:27
300	0:50	0:36	0:24	0:30	1:05	0:38	1:00	0:47	0:29	0:39	1:25	0:44
PCL5	N/A	N/A	N/A	0:13	0:27	0:22	N/A	N/A	N/A	0:16^d	0:52	0:22^d
COLOR												
100	1:53	0:56	0:50	0:29	0:55	N/A	2:24	2:05	1:12	0:46	1:30	N/A
300	4:30	2:30	1:22	1:34	3:20	N/A	6:01	3:18	1:49	2:15	4:50	N/A
PCL5	N/A	N/A	N/A	0:16	0:35	N/A	N/A	N/A	N/A	0:31^d	1:10	N/A

- a. Some DeskJets may not support 100 dpi resolution. If your plot is 2/3 size, use 150 dpi.
- b. These times were measured with the HP DeskJet 1200C in "paper-fast" mode.
- c. Do not use a color cartridge for mono print on single cartridge DeskJets.
- d. Print width set to 181 mm to more closely match the size of PCL landscape print.

Using a Keyboard

You can use an IBM PC-AT compatible keyboard with your analyzer. A keyboard is useful when entering and editing names for files and directories. It is also useful for creating and editing IBASIC programs.

All of the analyzer front panel hardkey and softkey functions can be activated from a keyboard also. See [“Front Panel Control using a Keyboard” on page 4-86](#).

To Connect the Keyboard

To connect a keyboard, first turn off the analyzer. Then connect a PC-AT compatible keyboard with a mini-DIN connector to the rear panel DIN KEYBOARD connector. See [Figure 1-4 on page 1-11](#) for the location of the keyboard connector. Turn the analyzer back on after the keyboard connector is fully inserted into the connector.

NOTE

If your keyboard has a standard (large 5-pin) DIN connector, you will need to use a DIN to mini-DIN (small 6-pin) adapter to connect the keyboard to the analyzer. These adapters are available as HP part no. 1252-4141. Contact the nearest HP sales or service office for more information.

To Use the Keyboard to Edit

Using a keyboard makes editing of file and directory names, or program lines quick and easy. You can also edit these items from the front panel of the instrument using the front panel knob and the softkeys. However, this process is very tedious.

Following is an example procedure to use a keyboard and the Re-Save State function to save an instrument state that you want to call "mixer".

1. Set up the instrument with the measurement parameters that you want to save. See [“Saving and Recalling Measurement Results” on page 4-57](#) for more information.
2. Press **(SAVE RECALL)** **Select Disk**, and choose where to store the instrument state.
3. Press **Prior Menu** **Re-Save State**.
4. Use the keyboard to backspace over the existing file name (don't worry, the existing file will not be written over), and then use the keyboard to type in `mixer`.
5. Press **(ENTER)** on the keyboard (or the analyzer) and the current instrument state will be saved to a file titled "mixer".

Front Panel Control using a Keyboard

A keyboard template was supplied with your shipment. If you place the template on your keyboard, you will always have the following information on hand. Should you misplace your keyboard template, you can reorder with part number 08712-80028.

You can use the key combinations below with a keyboard connected to the rear panel of the analyzer to activate the indicated front panel hardkeys and softkeys. Softkeys are the eight unlabeled keys to the right of the display. They are numbered from one (top) through eight (bottom).

Keyboard Front Panel Key Equivalents

Keyboard Function Key	Front Panel Equivalents		
		Shift	Ctrl
f1	Softkey 1	MEAS 1	SAVE RECALL
f2	Softkey 2	MEAS 2	HARD COPY
f3	Softkey 3	FREQ	SYSTEM OPTIONS
f4	Softkey 4	POWER	PRESET
f5	Softkey 5	SWEEP	BEGIN
f6	Softkey 6	MENU	
f7	Softkey 7	SCALE	
f8	Softkey 8	MARKER	
f9		DISPLAY	
f10		FORMAT	
f11		CAL	
f12		AVG	

For example, to select measurement channel 1 as the active channel, on the keyboard press **(Shift)** with **(F1)**. To preset the network analyzer with the keyboard, press **(Ctrl)** with **(F4)**. In each case, hold down the first key as you press the second key. To select **Softkey 1**, press **(F1)** alone.

In case of difficulty, make sure that the keyboard is connected to the DIN KEYBOARD connector on the rear panel. The keyboard must be IBM PC/AT compatible.

Print capabilities:

When you use the analyzer **HARDCOPY** function to dump a graph, you don't get the softkey menu that appears on the right-hand side of the analyzer display.

Pressing **Shift** **Print Screen** on a keyboard will dump the current graph along with the current softkey menu.

Using an External VGA Monitor



The rear panel VIDEO OUT COLOR VGA connector can be connected to a VGA compatible monitor for enhanced measurement viewing. This section describes how to customize the color on an external VGA monitor. Refer to [Chapter 7, “Front/Rear Panel,”](#) for more information on the VIDEO OUT COLOR VGA connector.

Customizing Color on an External Monitor

Although the analyzer's built-in monitor is monochrome, you can connect an external color monitor to the analyzer for customized viewing. Your analyzer is equipped with a standard VGA compatible connector on the rear panel. See [Chapter 7](#) for information on this connector.

The analyzer's default colors, selected by pressing **DISPLAY** **More Display** **Color Options** **Factory Default** or **Default 2**, were chosen for optimal viewing of measurement data and text on an external VGA color monitor. (**Factory Default** and **Default 2** settings differ only in the colors assigned to Trace 1, Trace 2, Mem 1, and Mem 2.) However, you can customize the color of various display items if desired.

When importing screen images into a web browser or word processor via the LAN interface, it is often desirable to select the inverse display option to give plots with white backgrounds

To customize the color on an external display, press **DISPLAY** **More Display** **Color Options** **Custom Colors**. First, select the item you want to change by pressing the **Select Item** key, and then use the front panel knob or the   keys to select the item you want to change. You can also use the analyzer's keypad to input the number of the item you want to change. Refer to the following table to identify item numbers.

Using Instrument Functions
Using an External VGA Monitor

Item #	Description
1	Background
2	Text
3	User Graphics Pen 2
4	User Graphics Pen 3
5	User Graphics Pen 4
6	User Graphics Pen 5
7	User Graphics Pen 6
8	User Graphics Pen 7
9	Inactive Text
10	Warning Text
11	Graticule
12	Trace 1
13	Mem 1
14	Trace 2
15	Mem 2
16	Text

For example, to change the color of the text on the external monitor from white to a different color, perform the following steps:

1. Press **DISPLAY** **More Display** **Color Options** **Custom Colors** **Select Item** .
2. Press **16** (item number for "text" from the previous list), and then **ENTER**.
3. Press **Saturation** **100** **ENTER**.
4. Press **Luminance** **100** **ENTER**.
5. Finally, press **Hue** and then use the front panel knob to adjust the color to the desired hue.

NOTE



All of the above color settings are retained when the analyzer is turned off or is preset. To restore the default colors, press **DISPLAY** **More Display** **Color Options** , **Factory Default** or **Default 2** .

Synchronizing and Positioning the Display

The analyzer provides a CRT adjustment feature which can be used to get an external monitor to synchronize properly, and to optimize the display's position. The following list explains how to use the CRT adjust features.

CAUTION

The CRT adjust settings also affect the analyzer's built-in display.

1. Press **SYSTEM OPTIONS** **System Config** **CRT Adjust** . When this key is pressed, a test pattern appears on the monitor(s). If you don't want the test pattern on the display while adjusting it, press **Remove Pattern** .
2. If your external monitor is a sync-on-green-signal monitor, press the **Sync Green on OFF** key to enable the sync-on-green capability.
3. Use the **Vertical Position** and **Horizontal Position** keys to vary the display's position on the monitor. After pressing one of these softkeys, use the front panel knob, the   keys, or the numeric keypad to vary the position of the display on the monitor.
4. Press **More** . For synchronizing your external monitor, use the **Vertical Back Porch** , **Horizontal Back Porch** , **Vertical Frnt Porch** , and **Horizontal Frnt Porch** keys to vary the vertical and horizontal front and back porch times until the display is optimal. Use **Restore Defaults** if necessary.
5. All of these settings are retained when the analyzer is turned off or preset.

5 **Optimizing Measurements**

Introduction

This chapter describes techniques and analyzer functions that help you achieve the best measurement results. The following sections are included in this chapter:

- “Increasing Sweep Speed” on page 5-3
- “Increasing Network Analyzer Dynamic Range” on page 5-9
- “Reducing Trace Noise” on page 5-12
- “Reducing Mismatch Errors” on page 5-15
- “Compensating for Phase Shift in Measurement Setups” on page 5-18
- “Measuring Devices with Long Electrical Delay” on page 5-21

Increasing Sweep Speed

You can increase the analyzer sweep speed (decrease sweep time) by avoiding the use of some features that require computational time for implementation and updating, such as bandwidth marker tracking.

You can also increase the sweep speed by making adjustments to the measurement settings. Listed below are some of the things that can be done to increase sweep speed.

- select the appropriate calibration type
- increase the start frequency
- set sweep time in AUTO mode
- widen the system bandwidth
- reduce the amount of averaging
- reduce the number of measurement points
- view a single measurement channel
- turn off alternate sweep
- turn off markers and marker tracking
- turn off spur avoidance
- minimize frequency span to avoid bandcrossings (8714ES only)

Select the Appropriate Calibration Type

The two-port method of calibration is the most accurate form of error correction for measuring two-port devices since it can account for all of the major sources of systematic error. However, because it uses both a forward and a reverse sweep when making a measurement, it increases total cycle time. Therefore, if measurement speed is of more importance than highest accuracy, you may want to use a different type of error correction than the two-port calibration. See [Chapter 6](#) for more information on calibration types.

To Increase the Start Frequency

Since the analyzer sweeps frequencies below approximately 20 MHz at a slower rate, you can increase the start frequency to speed up the sweep.

1. Press **(FREQ)** **Start** .
2. Enter the highest start frequency possible for your measurement.

To Set the Sweep Time to AUTO Mode

Auto sweep time mode (the factory preset instrument mode) maintains the fastest sweep speed possible for any particular measurement settings.

1. Press **(SWEEP)** and look at the **Sweep Time AUTO man** softkey label. When AUTO is all capital letters, it indicates that the analyzer is in auto sweep time mode. If MAN is all capital letters, the analyzer is in manual sweep time mode.
2. If necessary, press **Sweep Time auto MAN** to toggle the time mode to AUTO.

To Widen the System Bandwidth

Press **(AVG)** **System Bandwidth** to widen the IF bandwidth. As the bandwidth increases, the sweep speed gets faster and the trace noise increases.

Table 5-1 Relationship between System Bandwidth and Sweep Speed

System Bandwidth	Sweep Speed
Wide	fastest
Medium Wide	faster
Medium	fast
Medium Narrow	slow
Narrow	slower
Fine	slowest

To Reduce the Amount of Averaging

If averaging has been turned on (it is off in the factory preset condition), reducing the averaging factor (or turning it off altogether) will increase the analyzer's measurement speed. Averaging requires multiple sweeps which increases measurement time. Turning off averaging and using a narrower system bandwidth may produce faster results.

1. Press **AVG** **Average Factor** and enter an averaging factor that is less than the value displayed on the analyzer screen and press **ENTER**.
2. If you want to turn the averaging off, press **AVG** **Average on OFF**.

To Reduce the Number of Measurement Points

To reduce the number of measurement points, press **MENU** **Number of Points** and use the front panel knob, the **UP** **DOWN** keys, or the numeric keypad to enter the reduced number.

Generally, as the number of points is decreased, so is the sweep time. However, other factors will affect the sweep time such as:

- using frequency bands that contain very low frequencies (below approximately 20 MHz)
- the number of band crossing points encountered in a sweep (at approximately 1900 MHz, 2310 MHz, and 2620 MHz) (8714ES only)
- if the MHz/msec rate is above the maximum rate at which the source can be swept

The following graph shows an example of the relationship between the number of points, frequency span, and total cycle time. Total cycle time is defined as the time from the start of the sweep to the start of the next sweep. This graph was created with data from a setup on an 8714ES using **PRESET** **Factory Preset** conditions, except for number of points and sweep frequencies, as noted on the graph.

Figure 5-1

Relationship between Frequency Span, Total Cycle Time, and Number of Points

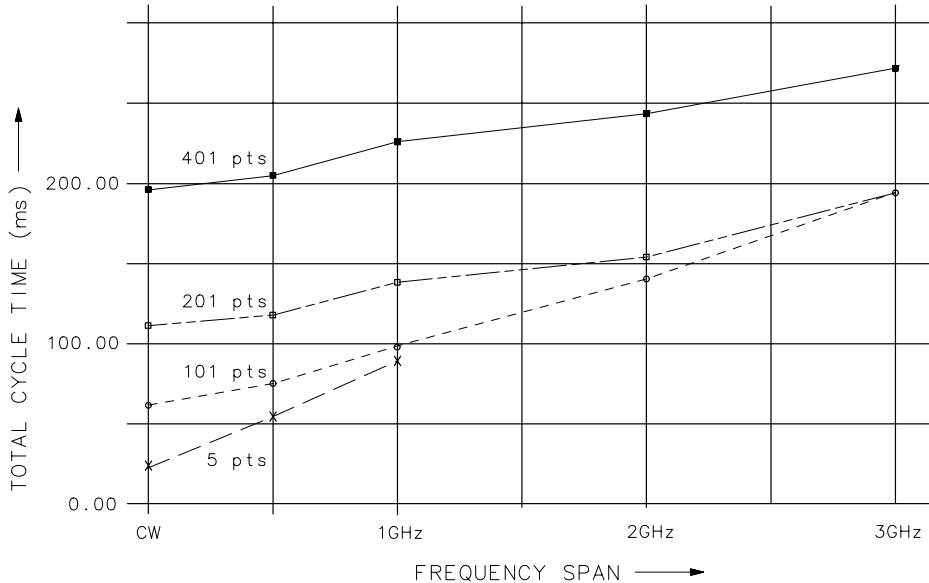

pp631es

Note the following in the graph above:

- As the frequency span decreases, the total cycle time generally decreases.
- As the number of points decreases, the total cycle time decreases.

To View a Single Measurement Channel

If you are viewing both measurement channels but only need one, you can decrease measurement time by turning one of the channels off.

Select the channel you wish to turn off with either the **MEAS 1** or **MEAS 2** button. Then select **Meas OFF**.

To Turn Off Alternate Sweep

Alternate sweep is turned off when the analyzer is preset, but is automatically activated with some dual channel measurements. The alternate sweep feature sweeps and measures one channel at a time. By disengaging this feature, you increase the sweep speed by a factor of two.

1. Press **(SWEEP)** and look at the **Alt Sweep on OFF** softkey.
2. If ON is in capital letters, toggle the softkey to disengage the alternate sweep feature (the softkey should appear **Alt Sweep on OFF**).

To Turn Off Markers and Marker Tracking

When markers are on, time is required to update the marker readouts. Turning off markers can reduce sweep cycle time by up to 30 ms. When the marker softkey menu is active, it too must be updated, adding up to 10 ms to the sweep cycle time.

Press **(MARKER)** **All Off** .

When marker tracking is on, the analyzer performs a search after each sweep. Simple searches like **Mkr -> Max** can take 10 to 20 ms per sweep. Lengthy calculations like **Bandwidth** can add over 100 ms to each sweep.

1. Press **(MARKER)** **Marker Search** and look at the **Tracking on OFF** softkey.
2. If ON is in capital letters, toggle the softkey to the OFF position.

To Turn Off Spur Avoidance

When spur avoidance is on (factory preset default is off), the analyzer breaks each sweep into segments. Between sweep segments, the analyzer stops and changes internal frequencies to ensure that unwanted mixing products don't affect the measurement. Since the analyzer sweep is not interrupted when this feature is off, turn off spur avoidance to increase sweep speed.

1. Press **(MENU)** **Spur Avoid Options** and look at the **Spur Avoid** softkey.
2. If the **Spur Avoid** key is highlighted with a box around it, press the **None** key.

NOTE

If Spur Avoid *must* be used in your measurement, set the start frequency as high as possible to obtain the fastest possible sweeps.

To Avoid Frequency Bandcrossings by Minimizing the Span (8714ES only)

Sweep time is increased when the analyzer encounters a bandcrossing point. The frequency bandcrossing points are approximately:

- 1900 MHz
- 2310 MHz
- 2620 MHz

Press **(FREQ)** and then change the start frequency, stop frequency, or span to avoid sweeping through these bandcrossing points when possible.

Increasing Network Analyzer Dynamic Range

Receiver dynamic range is the difference between the analyzer's maximum allowable input level and its noise floor. For a measurement to be valid, input signals must be within these boundaries. The dynamic range is affected by two factors:

- input power to the device under test (DUT)
- receiver noise floor

To Increase the Receiver Input Power

You should maximize the receiver input power to achieve the highest dynamic range. You can increase the analyzer's source output power as long as the test device output power stays within the measurement range of the analyzer.

Press **POWER** **Level** and enter the new source power level.

If your test device output power stays within the maximum input limits shown below, the receiver compression will be minimized.

Maximum Recommended Input Power Levels

	Maximum Recommended Input Power Level
Narrowband Mode	+10 dBm
Broadband Mode	+16 dBm

CAUTION

Remember to not exceed the receiver input damage limit of +26 dBm.

NOTE

The normalization power level may affect the analyzer's dynamic accuracy. Refer to [Chapter 9, "Specifications."](#)

To Reduce the Receiver Noise Floor

Receiver dynamic range is improved by reducing the system bandwidth and by increasing the averaging factor.

Changing System Bandwidth

Reducing the system bandwidth lowers the noise floor by digitally reducing the receiver input bandwidth. As system bandwidth is reduced, more receiver measurements are used per frequency point, increasing the sweep time. However with system bandwidth reduction, unlike averaging, only one sweep is required for the reduced noise floor effect.

The analyzer offers a choice of six system bandwidths: wide, medium wide (default setting), medium, medium narrow, narrow, and fine.

1. Press **AVG** **System Bandwidth** .
2. Press the key that corresponds to the bandwidth you want:

Wide 6500 Hz

Med Wide 4000 Hz

Medium 3700 Hz

Med Narrow 1200 Hz

Narrow 250 Hz

Fine 15 Hz

Changing Measurement Averaging

In averaging mode, the analyzer measures each frequency point once per sweep and averages the current and previous trace up to the averaging factor specified by the user. The instrument computes each data point based on an exponential average of consecutive sweeps weighted by the user-specified averaging factor.

As the averaging factor is increased:

- signal-to-noise ratio increases,
- time for each individual sweep remains the same, but
- total measurement time increases.

Averaging is better than system bandwidth reduction at minimizing very low frequency noise.

1. Press **AVG** **Average Factor** and enter an averaging factor that is less than the value displayed on the analyzer screen, followed by **ENTER**.
2. Press **Average on OFF**.

NOTE

When averaging is on, there is an indicator in the lower right corner of the analyzer's display. The display is in the form $AVG_{x,y}$ where "x" is the averaging factor for measurement channel 1, and "y" is the averaging factor for measurement channel 2. If only one measurement channel is on, the averaging indicator only displays that channel's averaging factor.

Reducing Trace Noise

To help reduce the effect of noise on the data trace, you can use three analyzer functions to activate measurement averaging, reduce system bandwidth, and eliminate spurious responses.

To Activate Averaging for Reducing Trace Noise

The analyzer uses a weighted running average for averaging. The noise is reduced with each new sweep as the effective averaging factor increments.

1. Press **AVG** **Average Factor** .
2. Enter a value followed by **ENTER**.
3. Press **Average on OFF** .

Averaging is explained more fully in the previous section.

To Change System Bandwidth for Reducing Trace Noise

By reducing the system bandwidth, you reduce the noise that is measured during the sweep. However, the decreased bandwidth may slow down the sweep. While averaging requires multiple sweeps to reduce noise, narrowing the system bandwidth reduces the noise on each sweep. See the previous section for a more detailed explanation of system bandwidth.

Press **AVG** **System Bandwidth** **Narrow 250 Hz** or **Fine 15 Hz** .

Narrower system bandwidths cause longer sweep times. When in auto sweep time mode, the analyzer uses the fastest sweep time possible for any selected system bandwidth. Auto sweep time mode is the default analyzer setting.

To Eliminate Receiver Spurious Responses

Spurious responses are undesirable signals that result from various internal mixing products.

The analyzer has two features to eliminate spurious responses. Both features shift the frequency of the spur without changing the RF output frequency. They shift the spur by changing frequencies internal to the analyzer that mix to produce the RF frequency. The features are:

- dither
- spur avoid

Dither is usually most effective for narrow frequency span measurements (generally <15 MHz), as explained in the following paragraph. If dither does not eliminate visible spurs, use spur avoid instead.

Dithering to Shift Spurs

Dither shifts all spurs by a small amount once, thus it imposes no sweep time penalty. But some spurs occurring within the measured frequency band may not be shifted out of band, and others may be shifted in. Therefore, dither is most effective for narrowband measurements with a user-defined measurement calibration. To activate dithering:

1. Press **(MENU)** **Spur Avoid Options** **Dither** .
2. Make a user-defined measurement calibration. Refer to [Chapter 6, "Calibrating for Increased Measurement Accuracy,"](#) for calibration procedures.

CAUTION

The measurement calibration must be performed with the same spur avoid option used in the measurement or your results may be invalid.

Activating Spur Avoidance

When you activate spur avoidance, the analyzer sweeps to a point before a spur, stops the sweep, shifts the spur, sweeps through the spur location, then shifts the spur back and continues the sweep. The analyzer determines which spurs need to be avoided with an algorithm based on frequencies, number of points, sweep time, and system bandwidth.

To activate spur avoidance:

1. Press **MENU** **Spur Avoid Options** **Spur Avoid** .
2. Make a user-defined measurement calibration. For calibration procedures, refer to [Chapter 6](#).

NOTE

Using spur avoid increases sweep time. Since there are more spurs at the lower frequencies, the time penalty can be reduced by setting the start frequency of the measurement as high as possible.

CAUTION

The measurement calibration must be performed with the same spur avoid mode used in the measurement or your results may be invalid.

CAUTION

You will invalidate the measurement calibration if you turn spur avoid off.

Reducing Mismatch Errors

Mismatch errors are due to the fact that the analyzer's port impedances are not exactly 50 ohms or 75 ohms across the frequency range. Source match errors are produced on the source side of the DUT; load match errors on the load side. If the DUT is not connected directly to the port, the mismatch errors due to cables, adapters, etc. are considered part of the source or load match errors. Source match and load match error terms can be reduced by using the methods described in this section.

Reducing Mismatch Errors in a Reflection Measurement

The best way to reduce mismatch errors in a reflection measurement of a two-port device is to perform a two-port calibration directly at the point that will connect to the DUT, using the exact frequency parameters that you will be using for the measurement. Though not quite as accurate as a two-port calibration, a one-port calibration can also be used to reduce mismatch errors. A one-port calibration offers the advantage of faster measurement speeds than when using a two-port calibration. The accuracy of a one-port calibration for a two-port device can be increased dramatically by terminating the output port of the device with a high quality Z_0 termination (a load from a calibration kit, for example) instead of connecting it to the analyzer.

1. Set up your S_{11} port 1 reflection measurement or S_{22} port 2 reflection measurement, and frequency parameters.
2. Press **CAL** **User 2-Port** or **User 1-Port**.
3. Follow the instructions on the display.

See [Chapter 6](#) for more information on calibration choices for reflection measurements.

Reducing Mismatch Errors in a Transmission Measurement

The best way to reduce mismatch errors in a transmission measurement of a two-port device is to perform a two-port calibration directly at the point that will connect to the DUT, using the exact frequency parameters that you will be using for the measurement. Though not quite as accurate as a two-port calibration, an enhanced response calibration can also be used to reduce source match errors. To minimize load match error, it is recommended that you use an attenuator on the output of the DUT. An enhanced response calibration offers the advantage of faster measurement speeds than when using a two-port calibration.

1. Set up your S_{21} forward transmission measurement or S_{12} reverse transmission measurement, and frequency parameters.
2. Press **CAL** **User 2-Port** or **CAL** **User Response** **Enhanced Response** .
3. Follow the instructions on the display.

See [Chapter 6](#) for more information on calibration choices for transmission measurements.

NOTE

If you choose to do an enhanced response calibration, it is recommended that you use a high quality attenuator on the output of the DUT, as shown in [Figure 3-38 on page 3-83](#). Six to ten dB of attenuation should be sufficient to significantly reduce mismatch errors.

NOTE

Using an attenuator on the output of the DUT will reduce the system dynamic range.

Reducing Mismatch Errors when Measuring Both Reflection and Transmission

When you want to measure reflection and transmission simultaneously, or without changing the test setup, perform a two-port calibration. Though not as accurate as a two-port calibration, both a one-port calibration for reflection and an enhanced response calibration for transmission can be performed using the exact frequency parameters that you will be using for the measurement. With this calibration choice, it is recommended that you put a 6 to 10 dB pad directly on the output of the DUT to improve measurement accuracy. Using both a one-port calibration and an enhanced response calibration offers the advantage of faster measurement speeds than when using a two-port calibration.

NOTE

Using an attenuator on the output of the DUT will reduce the system dynamic range.

Compensating for Phase Shift in Measurement Setups

Port Extensions

The port extension feature is used to compensate for the phase shift caused by the insertion of cables, adapters, and fixtures into the measurement path.

Port extension is particularly useful if you are unable to perform a calibration directly at your DUT. (See [Figure 5-2, “Compensating for Test Fixture Delay,”](#) for this discussion.) For example, you might have a test fixture with type-N connectors, where you can easily perform an accurate calibration. However, calibrating at this connector does not remove the electrical length within the fixture. The desired calibration reference plane is on the other side of the test fixture where you may have device specific connectors. Port extension lets you compensate for this delay within your fixture by removing the phase shift that it causes.

Figure 5-2 **Compensating for Test Fixture Delay**

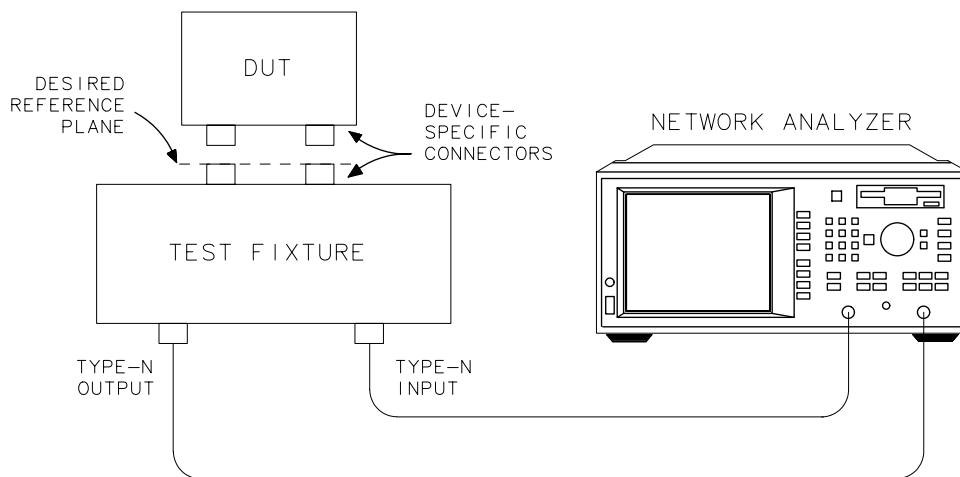

pp69es

To use the port extension feature, press **CAL** **More Cal** **Port Extensions** **Port Ext's on OFF** . When port extension is turned on, you can add delay independently to both ports.

To add delay between PORT 1 and your DUT, press **Port 1 Extension** , and enter the delay value.

To add delay between PORT 2 and your DUT, press **Port 2 Extension** , and enter the delay value.

TIP

A good way to know when you have added enough delay is to connect a short in place of the DUT. Adjust the port extension until the phase response is flat. (Remember that most short-circuit standards have a nonzero delay, so adjusting delay using this method will result in a delay error equal to two times the short delay.)

The delay values that you enter will be automatically applied appropriately to both transmission and reflection measurements. For example, when measuring S_{11} , the port 1 extension delay is applied twice. When measuring S_{21} , the port 1 extension delay and the port 2 extension delay are each applied once.

Electrical Delay

Another type of reference plane extension is **Electrical Delay**, accessible from the **SCALE** key. Electrical delay lets you add delay to your current measurement to compensate for phase shift. To flatten the phase response at a certain frequency, use **MARKER**

Marker Functions **Marker** -> **Elec Delay**. This automatically adjusts the electrical delay to compensate for the phase slope at the active marker position.

Electrical delay is commonly used in transmission measurements to measure a device's electrical length, or to remove phase slope to measure deviation from linear phase.

Unlike port extension, electrical delay does not automatically adjust the applied delay when you switch between transmission and reflection measurements. For this reason, port extensions are preferred over electrical delay for fixture compensation or when measuring one-port devices.

NOTE

Reference plane extension only affects measurements using the narrowband detectors.

Measuring Devices with Long Electrical Delay

When making narrowband-receiver measurements of devices with long electrical delay, measured levels can be affected by the rate at which the source is changing frequency. This sensitivity is related to the time required for the source signal to travel through cables or devices which are connected between the analyzer's two test ports. Since the source frequency is changing rapidly during a sweep, a long distance or delay between the analyzer's two test ports will mean that the signal arriving at the input port will be of slightly lower frequency than the output signal at the same moment in time. This effect is referred to as "frequency shift." The amount of frequency shift is given by the following equation:

$$\text{frequency shift} = \text{transit time} \times \frac{\text{frequency span}}{\text{sweep time}}$$

The narrowband receiver at the analyzer's input port is tuned to the exact frequency being emitted at the analyzer's output port, with an input bandwidth determined by the system-bandwidth selection. If the input signal is lower in frequency than the output signal, the measurement of the input signal will be attenuated by the frequency response of the system bandwidth. The amount of attenuation increases as the amount of frequency shift increases. The amount of attenuation also increases as system bandwidth decreases.

The analyzer has been designed to minimize the effect of frequency shift when a short cable is connected between the analyzer's two test ports. When a long cable (or a device with long electrical delay) is connected, however, it is possible for the measurement to be affected, especially at the analyzer's fastest sweep rates. If frequency shift is suspected, use the following techniques to reduce its effect:

- Increase sweep time.
- Decrease frequency span.
- Select a wider system bandwidth.
- Use shorter cables to connect the DUT to the analyzer.
- Use broadband detection to completely eliminate the effect of frequency shift.

6 **Calibrating for Increased Measurement Accuracy**

Introduction

This chapter first explains measurement calibration in the section titled “[Measurement Calibration Overview](#)” on [page 6-3](#). The sections following the overview provide instructions for choosing, performing, saving, and checking measurement calibrations.

Each example measurement in [Chapter 3, “Making Measurements,”](#) provides an example calibration for the particular type of measurement.

Measurement Calibration Overview

Measurement calibration is a process that improves measurement accuracy by using error correction arrays to compensate for systematic measurement errors. Measurement calibration is also called cal, accuracy enhancement, and error correction. Measurement errors are classified as random, drift, and systematic errors. Random errors, such as noise and connector repeatability, are non-repeatable and not correctable by measurement calibration. Drift errors, such as frequency and temperature drift, occur after a calibration has been performed and can only be removed by doing another calibration.

Systematic errors, such as tracking and mismatch, are the most significant errors in most RF measurements. Fortunately, systematic errors are repeatable and for the most part correctable, though small residual errors may remain. In brief, systematic errors are correctable.

Repeatable systematic errors are due to the frequency response of the receivers, leakage between the signal paths, and signal reflections due to mismatch in the test setup.

Figure 6-1 Systematic Measurement Errors

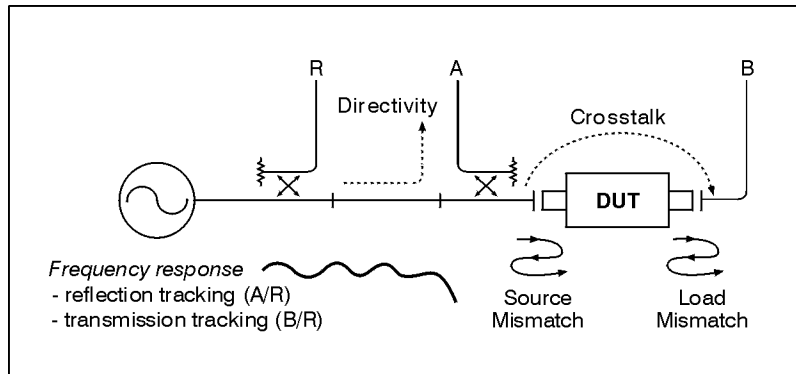

pp637es

Frequency response errors (transmission and reflection tracking) are caused by differences between the frequency response of the receivers used during ratio measurements.

Leakage errors result from energy leakage between signal paths. In transmission measurements, this leakage is due to crosstalk between test ports. In reflection measurements, it is due to imperfect directivity of internal signal-separation devices.

Mismatch errors are due to the fact that the analyzer's port impedances are not exactly equal to the system impedance across the frequency range. Source match errors are produced on the source side of the DUT; load match errors on the load side. If the DUT is not connected directly to the port, the mismatch errors due to cables, adapters, etc. are considered part of the source or load match errors.

Figure 6-2

Mismatch Errors in a Forward Reflection Measurement

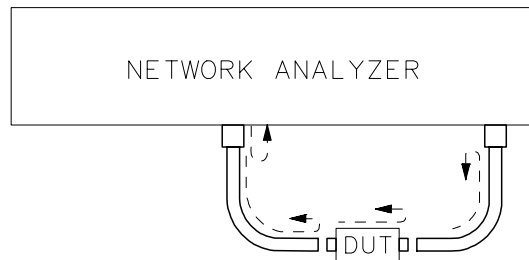

pp610es

The analyzer has several methods of measuring and compensating for these test system errors. Each method removes one or more of the systematic errors using an equation called an error model. Measurement of high quality standards (short, open, load, and through, for example) allows the network analyzer to solve for the error terms in the error model. The accuracy of the calibrated measurements is dependent on the quality of the standards used for calibrating. Since Agilent Technologies calibration standards are very precise, great accuracy is achieved.

When you perform a calibration, the analyzer calculates the difference between measurement data of known calibration standards and ideal measurement data to create error correction arrays. The network analyzer uses these error-correction arrays to correct subsequent measurement data.

To see all of the calibration choices available for measurements, refer to [Table 6-1, “Calibration Choices,” on page 10](#) and [Figure 6-4 on page 6-11](#).

The full two-port error model includes all six of the systematic error terms for the forward direction and the same six (with different data) in the reverse direction, for a total of twelve error terms. This full two-port vector-error correction accounts for all major sources of systematic error and gives the most accurate measurements of two-port devices. By default however, the analyzer’s **Isolation on OFF** softkey is turned off, resulting in a two-port error model that includes only ten error terms. This is done because the isolation calibration, which creates the eleventh and twelfth error terms, adds noise to the error model, and should only be used when measuring high-isolation devices and high-dynamic range devices. The selection of the **Isolation on OFF** softkey affects both the default two-port and the user two-port calibrations. The data for the isolation calibration is always collected (though not always used) in a two-port calibration when the analyzer is measuring the response of the load-standard with each port. It should be noted that because it corrects for ten or twelve error terms, the two-port error correction is the only calibration that can be used to measure all four S-parameters.

To perform a quality calibration:

- Use the highest quality standards available and take care of them.
- When performing a user two-port, user one-port, or an enhanced response calibration, be sure to select the correct cal kit by pressing **CAL** **More Cal** **Cal Kit** .
- Make consistent connections of the standards and DUTs (if possible, use a torque wrench when using 3.5 mm connectors).
- Minimize temperature variations.
- Use high-quality cables (semi-rigid cables, for example).
- Minimize movement of cables.

The Calibration Reference Plane

Most often you will not be connecting your DUT directly to the analyzer's front panel. More likely, you will be connecting your DUT to some sort of test fixture or cable(s) that is connected to the analyzer. See [Figure 6-3, "The Calibration Reference Plane."](#) The calibration reference plane is where you connect your calibration standards, and the measurement reference plane is where you connect your DUT. Best measurement results occur when these reference planes are aligned so that you calibrate out the effects of the test fixture and its associated cables and hardware. [Figure 6-3](#) illustrates that one method of aligning the reference planes is to connect your calibration standards at the same point that you connect your DUT. For information on selecting calibration standards, refer to ["Calibration Kits" on page 6-23](#). A less accurate method is to connect the calibration standards to the analyzer's ports and then use the port extensions feature, previously explained in [Chapter 5](#).

Figure 6-3

The Calibration Reference Plane

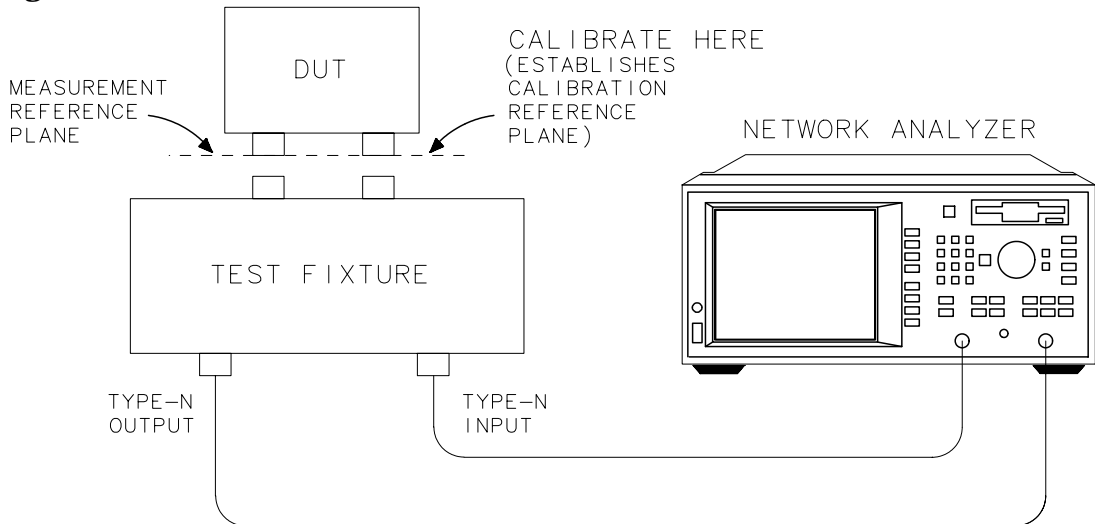

pp611es

Default versus User-Defined Calibration

The analyzer features factory-installed default calibrations that use vector error correction, so that measurements can be made on many devices without performing a user-defined calibration. These default calibrations are quick and convenient, but not as accurate as user-defined calibrations. This section shows you how to determine if your test setup is compatible with a default calibration or requires a user-defined calibration.

When to Use a Default Calibration

- Your test doesn't require the best accuracy possible.
- Your test device is connected directly to the analyzer's output port with no adapters or intervening cables.

If your test setup meets these conditions, you can use the default calibration rather than perform a user-defined calibration. However, without a user-defined calibration, the analyzer is not guaranteed to meet its published measurement port specifications.

When to Perform a User-Defined Calibration

- You want the best accuracy possible.
- You are adapting to a different connector type or impedance.
- You are connecting a cable between the test device and the analyzer's output port.
- You are measuring across a narrow frequency span or using an electrically long device.
- You are connecting any attenuator or other such device on the input or output of the test device.

Calibration Choices

To choose the appropriate calibration method suited to your type of measurement, follow these steps:

1. Set up the analyzer for your measurement:
 - Select **MEAS 1** or **MEAS 2**.
 - Enter operating parameters other than the default.
2. When performing some user-defined calibrations, you must select a calibration kit to match the port(s) at your calibration reference plane. A user two-port calibration requires you to select a calibration kit for each port. One-port calibrations, such as user one-port, and enhanced response, require you to select a calibration kit for only one port. Refer to “[The Calibration Reference Plane](#)” on page 6-7 and “[Calibration Kits](#)” on page 6-23.
3. Press the **CAL** key to bring up the calibration choices for the type of measurement you selected in step 1.

See [Table 6-1](#) and [Figure 6-4](#) for the calibration choices available for each type of measurement. Later sections in this chapter discuss these different types of calibrations, organized by measurement type. There is also a discussion of a type of calibration called normalization.

Table 6-1 Calibration Choices

Measurement Type	Calibration Choices
S ₁₁ Refl Port 1	Default 1-Port Default 2-Port User 1-Port User 2-Port
S ₂₁ Fwd Trans	Default Response Default 2-Port User Response: Response Response & Isolation Enhanced Response User 2-Port Normalize
S ₁₂ Rev Trans	Default Response Default 2-Port User Response Response Response & Isolation Enhanced Response User 2-Port Normalize
S ₂₂ Refl Port 2	Default 1-Port Default 2-Port User 1-Port User 2-Port
Fault Location (Option 100 only)	See your <i>Option 100 User's Guide Supplement</i> .
SRL (Option 100 only)	See your <i>Option 100 User's Guide Supplement</i> .
Power	Autozero Manual Zero Normalize
Conversion Loss	Autozero Manual Zero Normalize
Unratioed narrowband internal detection	Normalize

Figure 6-4 Calibration Choices (for S-parameter measurements only)

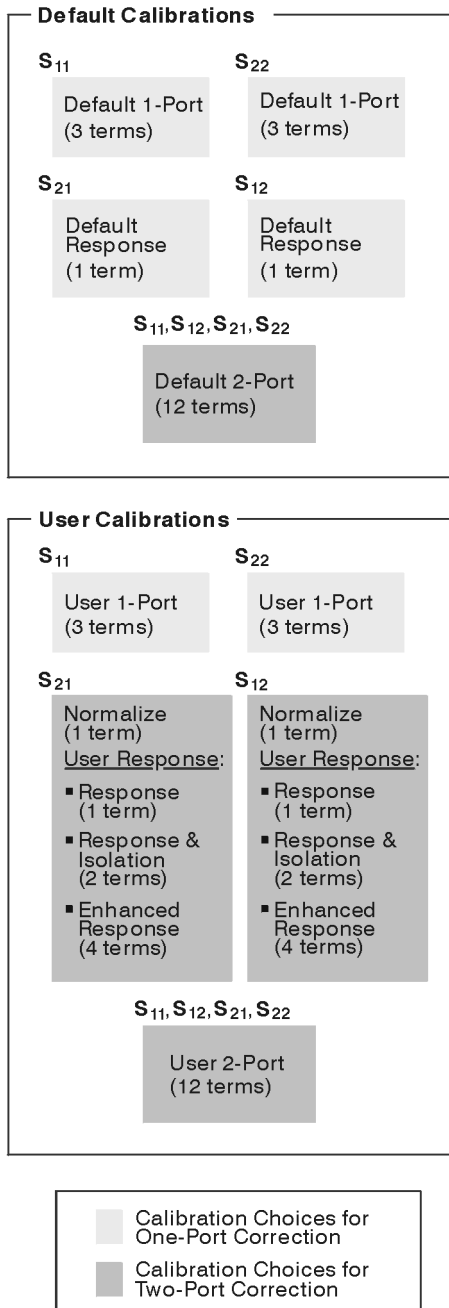

pp656

Retrieving Previous User-Defined Calibrations

User-defined calibrations that you have already performed may be available for you to use again. In some cases, you can retrieve these calibrations rather than perform new ones. The following user-defined calibrations, if previously performed (and not cancelled by manually selecting a default calibration of the same type), may be retrieved when current instrument settings are compatible:

- user two-port (for all S-parameter measurements)
- user one-port (for S_{11} and S_{22} measurements)
- user response (for S_{21} and S_{12} measurements)

Widening the frequency span after retrieving a user-defined calibration will invalidate it, and the analyzer will automatically restore the default calibration of the same type. The user-defined calibration will automatically be retrieved again when you narrow the instrument's frequency span to be compatible with that of the calibration.

Note that after you have retrieved a calibration, a "C" appears in the upper right hand corner of the display. This "C" indicates that a user-defined cal is in use. If you change to a narrower span, note that the "C" changes to "C?", indicating the analyzer is now interpolating between calibrated measurement points. The "C?" notation also appears when other system parameters, such as power, number of points, or sweep time, have changed.

User-defined calibrations are always cancelled when you manually select a default calibration of the same type. The following example illustrates this point:

A user one-port calibration (for S_{11} and S_{22}) is cancelled by manually selecting **Default 1-Port**. Note, however, that user response calibrations (for S_{21} and S_{12}) and a two-port calibration (for all S-parameters) are unaffected by this change.

Current user-defined calibrations are always available in nonvolatile (battery-backed) memory. Subsequent calibrations of the same type will cancel the previous calibration unless it is saved using **SAVE RECALL**. See [“Saving and Recalling the Calibration” on page 6-33](#). When the instrument's power is cycled, the current instrument state and calibration will be retrieved.

NOTE

A two-port calibration (default or user-defined) that is selected on one measurement channel will automatically be selected on the other measurement channel, unless the alternate sweep feature has been selected.

Presetting the Analyzer: How Calibration Is Affected

Two-Port Calibration

When the current calibration is a two-port calibration (user-defined or default) and the instrument is preset:

- a default calibration (not two-port) will be automatically restored, *or*
- a user-defined calibration (not two-port) will be automatically retrieved if its settings match those of the instrument's preset

After instrument preset—how to retrieve a previous user-defined two-port calibration:

1. Adjust the instrument settings to be compatible with those of the previous user-defined two-port calibration.
2. Select **User 2-Port**.

Other Calibrations

When the current user-defined calibration is anything except a user two-port and the instrument is preset:

- a default calibration will be automatically restored, *or*
- the current user-defined calibration will be retained if its settings match those of the instrument's preset

After instrument preset—how to retrieve a previous user-defined calibration:

1. Adjust the instrument settings to be compatible with those of the previous user-defined calibration.
2. Select the softkey of the calibration you want to retrieve.

To Perform a Normalization Calibration

Normalization is the simplest type of calibration. The analyzer stores data into memory and divides subsequent measurements by the stored data to remove frequency response errors.

Follow these general steps when performing a normalization calibration:

1. Set up the analyzer for your measurement:
 - Select the type of measurement.
 - Enter operating parameters other than the default.
2. Connect your equipment as you would for an actual measurement, but omit the DUT.
3. Press **DISPLAY** **Normalize** or **CAL** **Normalize on OFF**.
4. Notice that the top of the display on the analyzer now shows the type of measurement followed by "/M" to indicate that the displayed data is actually the measurement divided by memory.

CAUTION

The normalization cal will be invalidated if any frequency settings are changed after calibration. There is *no* correction interpolation with a normalization cal.

CAUTION

If you decide to perform any other type of calibration, be sure to turn off normalization first by pressing **DISPLAY** **Data** or **CAL** **Normalize ON off**. Note that the "/M" indicator disappears when normalization is turned off.

To Perform a Transmission Calibration

For a review of which systematic errors are removed by each type of transmission calibration, see the descriptions below. These calibrations are for narrowband-detection measurements only.

For examples of performing a two-port calibration and an enhanced response calibration for a transmission measurement, refer to [Chapter 3](#).

In general, follow these steps when performing a transmission calibration:

1. Set up the analyzer for your measurement:
 - Select **MEAS 1** or **MEAS 2**, **S21 Fwd Trans** or **S12 Rev Trans**.
 - Enter operating parameters other than the default.
2. When performing some user-defined calibrations, you must select a calibration kit to match the port(s) at your calibration reference plane. A user two-port calibration requires you to select a calibration kit for each port. An enhanced response calibration requires you to select a calibration kit for only one port. Refer to “[The Calibration Reference Plane](#)” on page 6-7 and “[Calibration Kits](#)” on page 6-23.
3. Press **CAL**, and then one of the following softkeys:

Default Response

Restoring the default calibration recalls error correction arrays that were calculated at the factory or during servicing and then permanently stored in memory. This response calibration was performed using full band (entire frequency span) and 401 frequency points, and corrects systematic frequency response errors. It does not correct for source and load match. It is quick and convenient but not as accurate at narrow frequency spans. When using this calibration to measure the cable supplied with the analyzer, the measured delay is 0 seconds. This calibration is also known as the default calibration.

Default 2-Port

Restoring the default two-port calibration recalls error correction arrays that were calculated at the factory or during servicing and then permanently stored in memory. This two-port calibration was performed using full band (entire frequency span) and 401 frequency points, and corrects systematic errors caused by frequency response, load match, source match, and directivity. It is quick and convenient but not as accurate at narrow frequency spans. The calibration reference planes are at the analyzer's port 1 and port 2, so if you use cables in your test setup you should adjust the port extensions to match the electrical lengths of the cables (see [“Port Extensions” on page 5-18](#)). Best accuracy would be achieved by performing a user-defined two-port calibration. When using the default 2-port calibration to measure the cable supplied with the analyzer, the measured delay is approximately 3 ns. When a two-port calibration is selected, the analyzer automatically measures all four S-parameters. To quickly view each of the four S-parameters press **(MENU) Trigger Hold**, and then press the desired S-parameter softkeys under the **(MEAS 1)** or **(MEAS 2)** menu. You may need to adjust the scaling to view each of the S-parameters.

NOTE

When toggled on, the **Isolation on OFF** softkey allows you to remove systematic errors caused by crosstalk. To select it, press **(CAL) User 2-Port Isolation on OFF Default 2-Port**. A two-port calibration always measures the same parameters, regardless of the setting of **Isolation on OFF**. Therefore, no further measurements of calibration standards are required when you enable the isolation calibration feature. When toggled ON, this feature will change the analyzer's calculations before displaying the data. Crosstalk can be a problem with high-isolation devices and high-dynamic range devices. Since this isolation calibration adds noise to the error model, you should only select it if it is really needed.

Response

A response calibration prompts you to connect a through cable as the calibration standard, and then measures it across the frequency band you have defined, using the number of points you have defined. This measurement is used to correct systematic frequency response errors. It does not correct for source and load match.

Response & Isolation

This method of calibration is only necessary when trying to achieve maximum dynamic range (>100 dB). A response and isolation calibration prompts you to connect loads to both ports and then to connect a through cable. These standards are measured across the frequency band you have defined, using the number of points you have defined. These measurements are used to remove systematic errors caused by frequency response and crosstalk. They do not correct for source and load match.

Enhanced Response

This method of calibration is superior to the standard response calibration. This calibration prompts you to connect an open, a short, and a load to port 1 (for measuring S_{21}), or port 2 (for measuring S_{12}) and to connect a through cable. The analyzer measures each standard across the frequency band you have defined, using the number of points you have defined. The measurements of these standards are used to remove systematic errors caused by frequency response and source match. They do not correct for load match.

User 2-Port

This method of calibration is the most accurate form of error correction for measuring two-port devices since it can account for all of the major sources of systematic error. This calibration prompts you to connect a through standard between port 1 and port 2, and then to connect an open, a short, and a load to port 1. Then it prompts you to connect an open, a short, and a load to port 2. The analyzer measures each standard across the frequency band you have defined, using the number of points you have defined. The measurements of these standards are used to remove systematic errors caused by frequency response, load match, source match, and directivity. When a two-port calibration is selected, the analyzer automatically measures all four S-parameters. To quickly view each of the four S-parameters press **MENU** **Trigger** **Hold** , and then press the desired S-parameter softkeys under the **MEAS 1** or **MEAS 2** menu. You may need to adjust the scaling to view each of the S-parameters.

NOTE

When toggled on, the **Isolation on OFF** softkey allows you to remove systematic errors caused by crosstalk. To select it, press **CAL** **User 2-Port Isolation on OFF User 2-Port**. A two-port calibration always measures the same parameters, regardless of the setting of **Isolation on OFF**. Therefore, no further measurements of calibration standards are required when you enable the isolation calibration feature. When toggled ON, this feature will change the analyzer's calculations before displaying the data. Crosstalk can be a problem with high-isolation devices and high-dynamic range devices. Since this isolation calibration adds noise to the error model, you should only select it if it is really needed.

Transmission Calibration Interpolation

Widening the frequency span after performing any of these calibrations will invalidate them, and restore the default calibration. You may narrow the span and the analyzer will interpolate between calibration points for the narrower span.

Note that after you have performed a calibration, a "C" appears in the upper right hand corner of the display. This "C" indicates that a user-defined cal is in use. If you change to a narrower span, note that the "C" changes to "C?", indicating the analyzer is now interpolating between calibrated measurement points. The "C?" notation also appears when other system parameters, such as power, number of points, or sweep time, have changed.

To Perform a Reflection Calibration

For a review of which systematic errors are removed by each type of reflection calibration, see the descriptions below. These calibrations are for narrowband-detection measurements only.

For examples of performing a two-port calibration and a one-port calibration for a reflection measurement, refer to [Chapter 3](#).

In general, follow these steps when performing a reflection calibration:

1. Set up the analyzer for your measurement:
 - Select **MEAS 1** or **MEAS 2**, **S11 Refl Port 1** or **S22 Refl Port 2**.
 - Enter operating parameters other than the default.
2. When performing some user-defined calibrations, you must select a calibration kit to match the port(s) at your calibration reference plane. A user two-port calibration requires you to select a calibration kit for each port. A user one-port calibration requires you to select a calibration kit for only one port. Refer to [“The Calibration Reference Plane” on page 6-7](#) and [“Calibration Kits” on page 6-23](#).
3. Press **CAL**, and then one of the following softkeys:

Default 1-Port

Restoring the default calibration recalls error correction arrays that were calculated at the factory or during servicing, and then permanently stored in memory. This one-port calibration was performed using full band (entire frequency span) and 401 frequency points, and corrects systematic errors caused by directivity, source match, and frequency response. It is quick and convenient but not as accurate at narrow frequency spans. The calibration reference plane is at the analyzer's port 1 (S_{11}) or port 2 (S_{22}), so if you use a cable in your test setup you should adjust the port extension to match the electrical length of the cable (see [“Port Extensions” on page 5-18](#)). Best accuracy would be achieved by performing a user-defined one-port calibration. This calibration is also known as the default calibration.

Default 2-Port

Restoring the default two-port calibration recalls error correction arrays that were calculated at the factory or during servicing and then permanently stored in memory. This two-port calibration was performed using full band (entire frequency span) and 401 frequency points, and corrects systematic errors caused by frequency response, load match, source match, and directivity. It is quick and convenient but not as accurate at narrow frequency spans. The calibration reference planes are at the analyzer's port 1 and port 2, so if you use cables in your test setup you should adjust the port extensions to match the electrical lengths of the cables (see “Port Extensions” on page 5-18). Best accuracy would be achieved by performing a user-defined two-port calibration. When using the default 2-port calibration to measure the cable supplied with the analyzer, the measured delay is approximately 3 ns. When a two-port calibration is selected, the analyzer automatically measures all four S-parameters. To quickly view each of the four S-parameters, press **(MENU) Trigger Hold**, and then press the desired S-parameter softkeys under the **(MEAS 1)** or **(MEAS 2)** menu. You may need to adjust the scaling to view each of the S-parameters.

NOTE

When toggled on, the **Isolation on OFF** softkey allows you to remove systematic errors caused by crosstalk. To select it, press **(CAL) User 2-Port Isolation on OFF Default 2-Port**. A two-port calibration always measures the same parameters, regardless of the setting of **Isolation on OFF**. Therefore, no further measurements of calibration standards are required when you enable the isolation calibration feature. When toggled ON, this feature will change the analyzer's calculations before displaying the data. Crosstalk can be a problem with high-isolation devices and high-dynamic range devices. Since this isolation calibration adds noise to the error model, you should only select it if it is really needed.

User 1-Port

A one-port calibration prompts you to connect an open, a short, and a load to port 1 (for measuring S_{11}), or port 2 (for measuring S_{22}). The analyzer measures each standard across the frequency band you have defined, using the number of points you have defined. The measurements of these standards are used to remove systematic errors caused by directivity, source match, and frequency response.

User 2-Port

This method of calibration is the most accurate form of error correction for measuring two-port devices since it can account for all of the major sources of systematic error. This calibration prompts you to connect a through standard between port 1 and port 2, and then to connect an open, a short, and a load to port 1. Then it prompts you to connect an open, a short, and a load to port 2. The analyzer measures each standard across the frequency band you have defined, using the number of points you have defined. The measurements of these standards are used to remove systematic errors caused by frequency response, load match, source match, and directivity. When a two-port calibration is selected, the analyzer automatically measures all four S-parameters. To quickly view each of the four S-parameters press **MENU** **Trigger** **Hold**, and then press the desired S-parameter softkeys under the **MEAS 1** or **MEAS 2** menu. You may need to adjust the scaling to view each of the S-parameters.

NOTE

When toggled on, the **Isolation on OFF** softkey allows you to remove systematic errors caused by crosstalk. To select it, press **CAL** **User 2-Port** **Isolation on OFF** **User 2-Port**. A two-port calibration always measures the same parameters, regardless of the setting of **Isolation on OFF**. Therefore, no further measurements of calibration standards are required when you enable the isolation calibration feature. When toggled ON, this feature will change the analyzer's calculations before displaying the data. Crosstalk can be a problem with high-isolation devices and high-dynamic range devices. Since this isolation calibration adds noise to the error model, you should only select it if it is really needed.

Reflection Calibration Interpolation

Widening the frequency span after performing the user one-port or user two-port calibration will invalidate it, and restore the default calibration. You may narrow the span and the analyzer will interpolate between calibration points for the narrower span.

Note that after you have performed a calibration, a "C" appears in the upper right hand corner of the display. This "C" indicates that a user-defined cal (not the default) is in use. If you change to a narrower span, note that the "C" changes to "C?", indicating the analyzer is now interpolating between calibrated measurement points. The "C?" notation also appears when other system parameters, such as power, number of points, or sweep time, have changed.

To Perform a Conversion Loss Calibration

Conversion loss measurements typically utilize only a normalization calibration. See [“To Perform a Normalization Calibration” on page 6-14](#), and [“Measuring Conversion Loss” on page 3-62](#).

When in conversion loss measurement mode, the analyzer is using its internal broadband detectors and pressing the **CAL** key calls up a menu for zeroing the detectors. Zeroing the detectors helps compensate for drift due to changes in ambient temperature. The two **CAL** selections for conversion loss mode are:

Autozero

Autozero periodically compensates for detector drift due to changes in temperature. When autozero is selected, the detectors are automatically zeroed approximately every five minutes. A pop-up message will briefly appear on the analyzer's display when the detectors are zeroed.

Manual Zero

In manual zero mode, the analyzer zeros the detectors only when the **Manual Zero** softkey is pressed.



NOTE

When zeroing the detectors, the analyzer turns off the internal RF source. If you are measuring an external source with the broadband detectors, use **Manual Zero** *before* the external source is connected to the analyzer's input port.

Calibration Kits

When performing some user-defined calibrations, you must select a calibration kit to match the port(s) at your calibration reference plane. A user two-port calibration requires you to select a calibration kit for each port. One-port calibrations, such as user one-port, and enhanced response, require you to select a calibration kit for only one port. Refer to “The Calibration Reference Plane” on page 6-7.

Selecting a Calibration Kit Stored in the Analyzer

To select a calibration kit, press **CAL** **More Cal** **Cal Kit** and use the front panel knob or the   keys to highlight the desired port in the display's table. Next, select the softkey for the connector type of your port, or press **More Cal Kits** and select the softkey for one of ten user-defined calibration kits (User Cal Kit A–J).

Calibrating for Increased Measurement Accuracy
Calibration Kits

The following table shows the calibration kits that are stored in the analyzer.

Cal Kit Model Number	Impedance	Connector Type	For Use with Male Test Ports	For Use with Female Test Ports
85039B	75 Ω	type-F	✓	✓
85036B	75 Ω	type-N	✓	✓
85036E	75 Ω	type-N		✓
85032B	50 Ω	type-N	✓	✓
85032E	50 Ω	type-N		✓
85031B	50 Ω	APC-7	N/A	N/A
85033D	50 Ω	3.5 mm	✓	✓
85038A	50 Ω	7-16	✓	✓
85038F	50 Ω	7-16	✓	
85038M	50 Ω	7-16		✓

NOTE

By convention, cal kit labels in the analyzer indicate the sex of the *port* with which they are used. For example, the default cal kit for the analyzer is type-N *female* because the front panel RF ports are female (the calibration standards, in turn, have male connectors).

Creating a User-Defined Calibration Kit

A user-defined calibration kit is created by modifying a kit that is already listed under the Cal Kit menu and saving this modified kit as one of ten User Cal Kits (User Cal Kit A–J). (The original kit remains unchanged.) There are several situations that may require you to create a user-defined calibration kit:

- Your port has a connector type listed under the Cal Kit menu, but your calibration standards (such as a short) have different characteristics than the standard Agilent calibration kits.
- Your port has a connector type which does not correspond to one of the standard Agilent calibration kits.
- You are calibrating for a noninsertable device. Refer to [“Method B: Modify the Calibration Kit Definition of the Through Standard” on page 3-30](#).
- You are calibrating for a multiport device that has one or more noninsertable port pairs. Refer to your multiport test set’s *User’s and Service Guide* for more information.

NOTE

If your port has a connector type (TNC for example) which is not one of the selections under the Cal-Kit menu, you may want to select APC-7 as your port since it has nearly ideal characteristics. Next, modify the calibration-kit characteristics so they match those of the TNC standards that you will use, and store the user-defined kit as one of ten User Cal Kits (User Cal Kit A–J).

The following steps (explained later in detail) should be performed when creating a user-defined calibration kit file:

1. Determine the characteristics of the calibration standards you plan to use.
2. Create a user-defined calibration kit in either of the following ways:
 - Use the softkeys under the Modify Kit menu and store the calibration kit as one of ten User Cal Kits (User Cal Kit A–J).
 - Edit the ASCII file provided on the *Example Programs Disk* or create your own ASCII file, and download it into the analyzer as one of ten User Cal Kits (User Cal Kit A (default) or User Cal Kit B–J).

NOTE

Calibration kit definitions *must* be in DOS format. LIF format is not supported for cal kit definitions.

3. Verify performance.

Step 1: Determine the Characteristics of the Calibration Standards

Determine the characteristics of the calibration standards you plan to use. In particular, these are the characteristic impedance (Z_0), the delay, and the loss. These characteristics are common for the four supported standard types used by the analyzer. Additionally, the capacitive model parameters, C_0 , C_1 , C_2 , and C_3 are necessary for fully defining the open. These electrical characteristics can be mathematically derived from the physical dimensions and material of each calibration standard or from its actual measured response.

About Calibration Standards. A calibration **standard** is a specific, well-defined, physical device used to determine systematic errors. Each standard has a precisely known or predictable magnitude and phase response as a function of frequency. The response of each standard is mathematically defined in the error models used by the network analyzer.

A standard **type** is one of four basic types that define the form or structure of the model to be used with that standard (i.e., short, open, load, and through).

Standard **characteristics** are the numerical, physical characteristics of the standards used in the model selected.

Typical calibration standards are throughs, opens, shorts, and loads. All of these standards offer the advantage of broadband frequency coverage. They are used singly or in combination, depending on the type of cal.

Open defines the standard type of an open circuit.

Short defines the standard type of a short circuit.

Load defines the standard type of a load.

Through defines the standard type as a transmission line of specified length. The through has zero length when the two test ports can be connected directly together.

For all four standard types, the **Z₀** (characteristic impedance), **Delay**, and **Loss** must be set. For an open, **C₀**, **C₁**, **C₂**, and **C₃**, the capacitive model parameters, must also be set.

NOTE

When creating a user-defined calibration kit, if a standard is not defined, the currently defined values for that standard will be retained. The best practice is to define all of your standards and characteristics when creating a user-defined calibration kit.

Z₀ Z₀ is usually set to the system characteristic impedance (usually either 50 or 75 ohms).

Delay Delay is equivalent to a uniform length of transmission line between the standard being defined and the actual measurement plane. For an open, short, and load, the DELAY is entered as the one-way travel time from the measurement plane to the standard in seconds. For a through, the DELAY is entered as the one-way travel time between the measurement planes in seconds. Delay can be measured or determined from the precise physical length of the standard, divided by the velocity factor.

CAUTION

If two ports will be connected with a through during calibration, the calibration kits for each of these ports must be modified using the identical delay value for the through.

Loss Loss is used to specify energy loss, due to skin effect, along a one-way length of coaxial delay. The value of loss is entered as ohms/second at 1 GHz. For many applications, the loss value can be set to zero without noticeable degradation. To compute the loss of your device, measure the delay in seconds and the loss in dB at 1 GHz. Then, compute:

$$\text{Loss}\left(\frac{\Omega}{s}\right) = \frac{\text{loss (dB)} \times Z_0(\Omega)}{4.3429(\text{dB}) \times \text{delay}(s)}$$

C₀, C₁, C₂, C₃ At high frequencies, an open rarely has perfect reflection characteristics because fringing capacitance causes phase shift that varies with frequency.

These effects are impossible to eliminate, but the calculation built into the analyzer includes an open-circuit capacitance model. This capacitance model is a third-order polynomial as a function of frequency, where the polynomial coefficients are user-definable.

The capacitance model equation is: $C(f) = (C_0) + (C_1 * f) + (C_2 * f^2) + (C_3 * f^3)$ where f is the measurement frequency.

The terms in the equation are defined when specifying the open as follows:

- C_0 is used to enter the C_0 term, which is the constant term of the third-order polynomial and is expressed in Farads.
- C_1 is used to enter the C_1 term, expressed in F/Hz (Farads/Hz).
- C_2 is used to enter the C_2 term, expressed in F/Hz².
- C_3 is used to enter the C_3 term, expressed in F/Hz³.







For further information on calibration kits and determining standard characteristics, refer to Agilent Product Note 8510-5A (Publication No. 5956-4352). To view this product note on the Web, go to <http://www.tm.agilent.com> and select “Application Note Library.”

Step 2: Create a User-Defined Calibration Kit

A user-defined calibration kit can be created by either of these two methods:

- Method A: use the softkeys under the Modify Kit menu.
This method provides a convenient and quick way to modify calibration kit standards. Use this method during the development of new calibration kit standards.
- Method B: use an ASCII file.
This method provides a way to manage calibration kit descriptions in separate files. Use this method to keep permanently filed descriptions of your calibration kits.

Method A: Use the softkeys under the Modify Kit menu.

Press **CAL** **More Cal** **Cal Kit** and use the front panel knob or the   keys to highlight the desired port in the display's table. Select the softkey that matches the connector type of your port. Next, press **Modify (connector type)**, select the softkey of the appropriate calibration standard, select the softkey of the characteristic you want to modify, and enter the data using the keypad and softkeys. When you're done modifying all of the appropriate calibration standards and characteristics, press **Prior Menu**, **Mod Kit SaveRecall**. Use the front panel knob or the   keys to highlight the desired User Kit in the display's table and press **Save**. The display's table will now indicate that your user-defined calibration kit applies to the port you highlighted earlier. If you want to enter a cal kit description in the display's table, press **Add Kit Description**. Use a keyboard connected to the analyzer's DIN KEYBOARD connector to enter the description. (If you don't have a keyboard, you can use the analyzer's   keys or the front panel knob and the **Select Char** key to select and enter characters from the top of the analyzer's display. Press **Enter** when done.) User Cal Kits A–J are saved in nonvolatile memory in the method just described. Saving the instrument state also saves the Cal Kit.

Method B: Use an ASCII file. You can edit the ASCII file provided on the *Example Programs Disk* or create your own ASCII file. (Remember that these files are compatible with MS-DOS, and thus, you could use any IBM-compatible PC and a text editor that can modify ASCII files. Just be sure to include the line numbers as if it were an IBASIC program.) You can't read calibration kit data from the analyzer as an ASCII file.

ASCII file example. The example program, "CALKIT," provided on the *Example Programs Disk*, is listed below. Please note that the program allows you to specify storing the downloaded file as one of ten User Cal Kits (User Cal Kit A–J) in the analyzer. If not specified, however, the file is stored in Cal Kit A. When reading the cal kit file, the analyzer recognizes only the information after the "!" and ignores everything after a "\$". You can add comments after a "\$". The first line of a cal kit file *must* contain a "!" with a "\$" directly after it. No characters are allowed between the "!" and the "\$" on the first line of a cal kit file.

```
10  !$ Standard Definitions for HP 85054B Precision Type-N Cal
Kit.
20  !
30  !$ Definitions for 50 Ohm jack (FEMALE center contact) test
40  ! NAME: Load this file into the User Cal Kit selected in the
next line.
50  ! Kit B $ Select Cal Kit B
60  !$ ports, plug (MALE center contact) standards.
70  !
80  ! OPEN: $ HP 85054-60027 Open Circuit Plug
90  !     Z0 50.0 $ Ohms
100 !     DELAY 57.993E-12 $ Sec
110 !     LOSS 0.8E+9 $ Ohms/Sec
120 !     C0 88.308E-15 $ Farads
130 !     C1 1667.2E-27 $ Farads/Hz
140 !     C2 -146.61E-36 $ Farads/Hz^2
150 !     C3 9.7531E-45 $ Farads/Hz^3
160 !
170 ! SHORT: $ HP 85054-60025 Short Circuit Plug
180 !     Z0 50.0 $ Ohms
190 !     DELAY 63.078E-12 $ Sec
200 !     LOSS 8.E+8 $ Ohms/Sec
210 !
220 ! LOAD: $ HP 00909-60011 Broadband Load Plug
230 !     Z0 50.0 $ Ohms
240 !     DELAY 0.0 $ Sec
250 !     LOSS 0.0 $ Ohms/Sec
260 !
270 ! through: $ HP 85054-60038 Plug to Plug Adapter
280 !     Z0 50.0 Ohms
290 !     DELAY 196.0E-12 $ Sec
300 !     LOSS 2.2E+9 $ Ohms/Sec
310 !
320 END
```

How to download a calibration kit ASCII file. After creating a calibration kit ASCII file, you can download the program by following these steps:

NOTE

Calibration kit definitions *must* be in DOS format. LIF format is not supported for cal kit definitions.

1. Insert the disk with the cal standard definitions into the analyzer's built-in disk drive.
2. Press **SAVE RECALL** and note the first word of the second line on the screen. If it is not "INT:\\" (for internal disk), press **Select Disk Internal 3.5" Disk Prior Menu**.
3. Highlight the file (CALKIT, in the case of the *Example Programs Disk*).
4. Press **Recall State** and wait for the prompt:

```
Loaded cal kit information for 4 calibration standards  
Recall of cal kit from CALKIT complete
```
5. Press **CAL More Cal Cal Kit More Cal Kits**, and use the front panel knob or the **↑** **↓** keys to highlight the desired port in the display's table. Next, select the softkey that corresponds to the User Cal Kit where the ASCII program stored the calibration kit (default is User Cal Kit A).

NOTE

Cal kit coefficients are displayed in the cal kit block of the operating parameters screen; press **SYSTEM OPTIONS Operating Parameters**; press **Next Screen** a total of four times.

Step 3: Verify Performance

Once a measurement calibration has been generated with a user-defined calibration kit, its performance should be checked before making device measurements. To check the accuracy that can be obtained with the user-defined calibration kit, a device with a well-defined frequency response (preferably unlike any of the standards used) should be measured. The verification device must not be one of the calibration standards: measurement of one of these standards is merely a measure of repeatability.

To achieve more complete verification of a particular measurement calibration, accurately known verification standards with a diverse magnitude and phase response should be used. NIST-traceable standards (such as Agilent verification standards) are recommended to achieve verifiable measurement accuracy.

CAUTION

The published specifications for your analyzer system include accuracy enhancement with compatible calibration kits. Measurement calibrations made with user-defined calibration kits are not subject to those analyzer specifications.

To preset one of the ten User Cal Kits (User Cal Kit A–J) to a type-N(f) calibration kit, press **CAL** **More Cal** **Cal Kit** . Use the up or down arrows or the front panel knob to highlight the User Cal Kit you wish to preset. Press **Modify (Cal Kit type)** **Mod Kit SaveRecall** **Preset User Kit** .

To preset *all* of the ten User Cal Kits (User Cal Kit A–J) to type-N(f) calibration kits, press **CAL** **More Cal** **Cal Kit** . Use the up or down arrows or the front panel knob to highlight one of the User Cal Kits. Press **Modify (Cal Kit type)** **Mod Kit SaveRecall** **Preset All User Kits** .

When this preset is done, the size of your saved instrument state becomes slightly smaller since the instrument doesn't save the user-defined calibration kit. The instrument state can be saved by pressing **SAVE RECALL** **Save State** . Refer to [“Saving and Recalling Measurement Results”](#) on page 4-57.

Saving and Recalling the Calibration

Saving the Calibration

After you have performed your calibration, it is automatically saved in non-volatile (battery-backed) memory. However, it will be overwritten with subsequent calibrations of the same type. To save your calibration to the analyzer's internal non-volatile RAM disk, volatile RAM disk, or a floppy disk in the built-in disk drive:

1. Press **SAVE RECALL** **Define Save** **Cal on OFF** which will toggle the save cal function to ON.
2. Press **Prior Menu** **Select Disk** and select where you want the calibration saved. See [“Saving and Recalling Measurement Results” on page 4-57](#) for information on the three available selections.
3. Press **Prior Menu** **Save State** to save the calibration.
4. The analyzer will save the calibration along with the current instrument state to a file on the disk you have selected.

Recalling the Calibration

Measurement calibration information is linked to the instrument state and measurement parameters for which the calibration was done. Therefore, a saved calibration can be recalled and used for multiple instrument states as long as the measurement parameter, frequency range, and number of points are compatible. To recall your calibration from the analyzer's internal non-volatile RAM disk, volatile RAM disk, or a floppy disk in the built-in disk drive:

1. Press **SAVE RECALL** **Select Disk** and press the key that corresponds to the location where your desired file exists.
2. If necessary, change directories to the directory that contains the desired file as described in [“To Use Directory Utilities” on page 4-67](#).
3. Press **Prior Menu** and turn the front panel knob to move the highlighted bar to the file you want to recall.
4. Press **Recall State** to recall the desired file to the network analyzer.

NOTE

Refer to [“Saving and Recalling Measurement Results” on page 4-57](#) for more information on saving, recalling, renaming, and copying files.

7 **Front/Rear Panel**

Introduction

This chapter contains detailed information on various aspects of the analyzer front and rear panel. Information on the following can be found in this chapter:

- “Connectors” on page 7-3
- “Display” on page 7-16
- “Knob” on page 7-18
- “Power Switch” on page 7-19
- “Display Intensity Control” on page 7-20
- “Disk Drive” on page 7-21
- “Line Module” on page 7-22

The front panel keys are not documented in this chapter. Refer to [Chapter 8, “Hardkey/Softkey Reference,”](#) for information on a particular front panel key.

Connectors

Figure 7-1 Analyzer Connectors - Front Panel

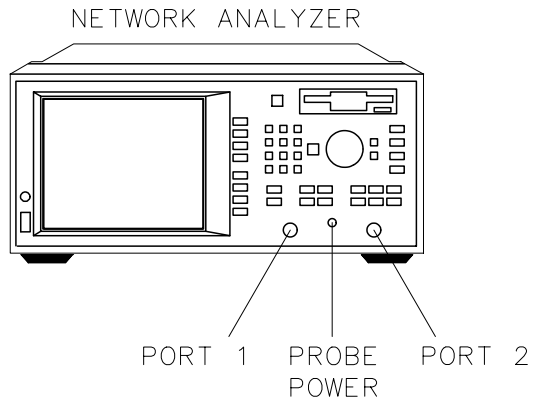

pp617es

Figure 7-2 Analyzer Connectors—Rear Panel BNC Connectors

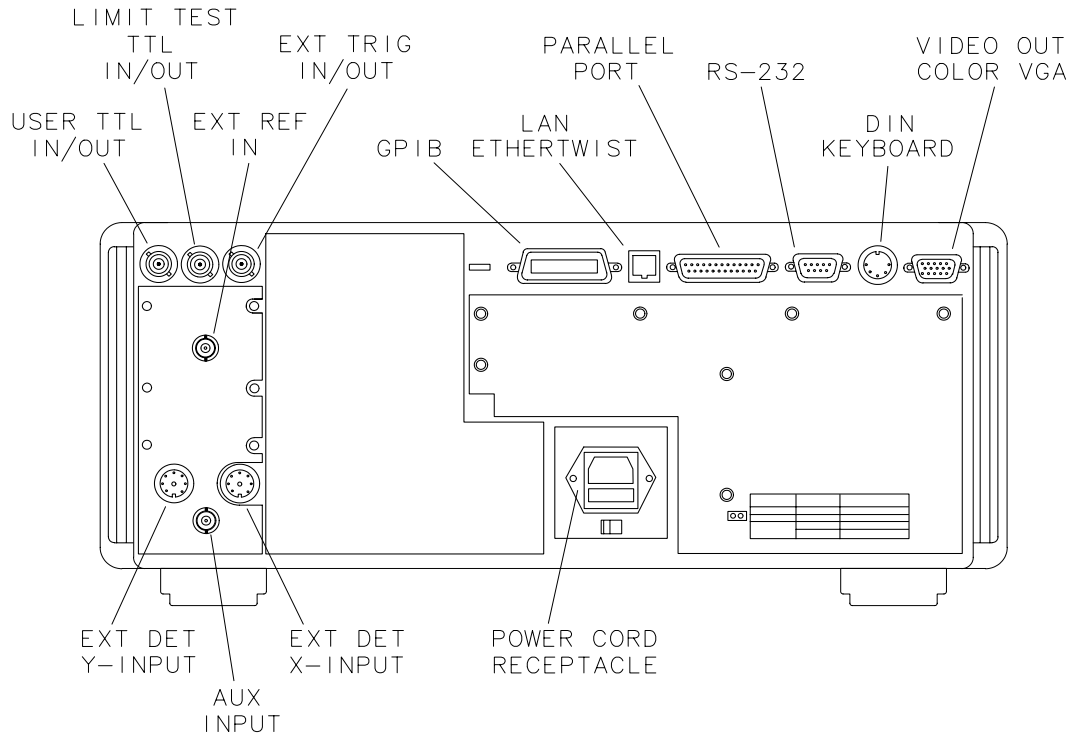

pp67c

AUX INPUT This rear panel female BNC connector is for low frequency (dc to approximately 360 Hz), low voltage measurements. This input is calibrated for inputs up to ± 10 V, but will accept signals up to ± 15 V. See [“Making Measurements with the Auxiliary Input”](#) on page 3-68 for more information.

EXT REF IN This rear panel female BNC connector accepts a > -5 dBm 10 MHz signal from an external time base reference. The nominal input impedance is 50 Ω .

**EXT TRIG
IN/OUT**

This rear panel female BNC connector allows triggering of a analyzer sweep by an external signal. When the external signal is pulled to a high TTL level, the analyzer is triggered to do either one complete sweep, or sweep to the next (frequency) point. (The type of sweep that gets triggered is determined by the softkey selection made under the Trigger Source menu.) When the external signal is pulled to ground, triggering is inhibited. This connector also acts as an output: during a sweep, the analyzer pulses a low TTL level each time a (frequency) point is measured. This is an open-collector signal which you can drive low, but must not drive high, since the analyzer also drives it.

**LIMIT TEST
TTL IN/OUT**

This rear panel female BNC connector provides a bi-directional open-collector TTL high signal. The output goes high when the limit test passes. The output goes low if the limit test fails. This is an open-collector signal which you can drive low, but must not drive high, since the analyzer also drives it.

NOTE

Limit testing can be set independently on each of the two measurement channels. If both measurement channels are being used, and the limit test is ON for both channels, both measurement channels must pass for the output to go high. See the following table.

Measurement Channel 1	Measurement Channel 2	Limit Test TTL Output
Pass	Pass	High (pass)
Pass	Fail	Low (fail)
Fail	Pass	Low (fail)

If limit testing is turned off for both measurement channels, this connector also serves as a user-defined TTL input and output that can be set and read from IBASIC or SCPI (GPIB). See the *Automating Measurements User's Guide Supplement* for more information.

USER TTL IN/OUT

This rear panel female BNC connector can be used in three different ways. Define its use by pressing **SYSTEM OPTIONS** **System Config** **User TTL Config**, and then making the appropriate selection.

- The default use for this connector provides a bidirectional open-collector TTL signal which can be set or read from IBASIC or SCPI (GPIB). This is an open-collector signal which you can drive low, but must not drive high, since the analyzer also drives it. See the *Automating Measurements User's Guide Supplement* for more information.
- This connector can also be used with an external switch to automate softkey presses. See "User-Defined BEGIN Key Menu" and "Using Fast Recall with a Switch" in the *Automating Measurements User's Guide Supplement*.
- Lastly, this connector can be configured for use as a sweep out connector. When configured this way, the output is driven high during a sweep.

Multi-pin Connectors

GPIB

This connector allows the analyzer to be connected to other instruments or devices on the interface bus. Details of this cable are shown in [Figure 7-3](#). Part numbers for various GPIB cables that are available are shown in the table following the figure.

Figure 7-3 GPIB Connector and Cable

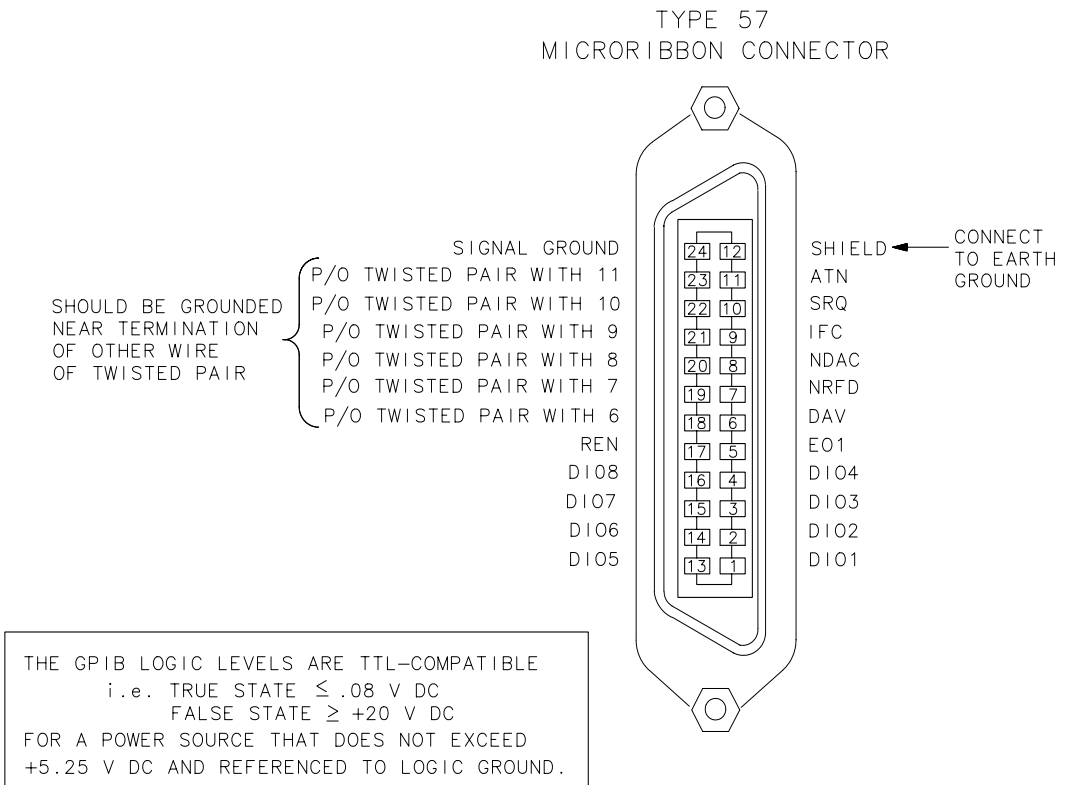

po658b.

Table 7-1 GPIB Interface Cables Available

GPIB Cable Part Number	Length
10833A	1 m (3.3 ft)
10833B	2 m (6.6 ft)
10833C	4 m (13.2 ft)
10833D	0.5 m (1.6 ft)

As many as 14 GPIB instruments can be connected to the analyzer (15 total instruments in the system). The cables can be interconnected in a star pattern (one central instrument with the GPIB cables emanating from that instrument like spokes on a wheel), or in a linear pattern (like boxcars on a train), or a combination of the two. See [Figure 1-5, “GPIB Connection Configurations,”](#) on [page 1-13](#). There are certain restrictions that must be followed when interconnecting instruments:

- Each instrument must have a unique GPIB address, ranging from 0 to 30.
- In a two-instrument system that uses just one GPIB cable, the cable length must not exceed 4 meters (13.2 ft).
- When more than two instruments are connected on the bus, the cable length to each instrument must not exceed two meters (6.6 ft).
- The total cable length between all instruments must not exceed 20 meters (66 ft).

Agilent Technologies manufactures GPIB extender instruments (Models 37204A and 37204B) that overcome the range limitations imposed by the cabling rules. These extenders allow twin pair cable operation up to 1 km (3,280 ft), and telephone modem operation over any distance. The Agilent Sales and Service Offices can provide additional information on the GPIB extenders.

Table 7-2 General Bus Management Lines

Name	Mnemonic	Description
Attention	ATN	Controls whether the bus is in Command Mode (ATN TRUE) or Data Mode (ATN FALSE).
Interface Clear	IFC	Initializes the interface to an idle state (no activity on the bus).
Service Request	SRQ	Alerts the Controller to a need for communication.
Remote Enable	REN	Enables devices to respond to Remote Program Control when addressed to listen.
End Or Identify	EOI	Indicates last data byte of a multibyte sequence; also used with ATN to parallel poll devices for their status bit.

Front/Rear Panel
Connectors

PARALLEL PORT This rear panel connector is used with peripherals with parallel interface such as printers and plotters. The pin-out is standard IBM PC compatible Centronics interface, using a female DB-25 connector, as shown in [Figure 7-4](#). All pins are ESD protected; data and strobe pins have 2200 pF capacitors; voltage levels are TTL compatible; output pins can source 15 mA and sink 24 mA. See [“Configure the Hardcopy Port” on page 4-73](#) for information on using this port with a printer or plotter.

Figure 7-4 Parallel Port Pin-outs

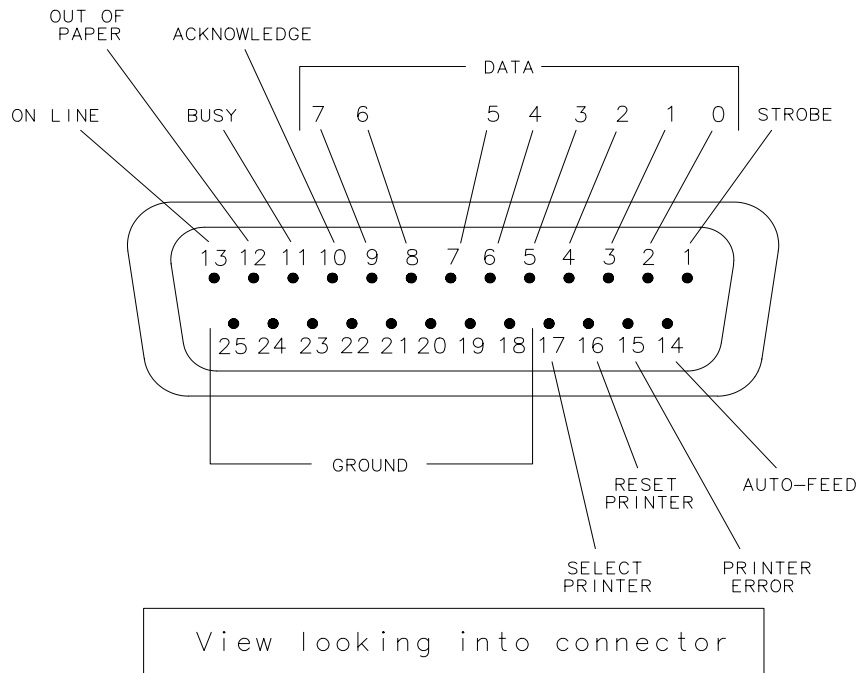

po622b

RS-232

The RS-232 connector is a rear panel connector used with serial peripherals such as printers and plotters. The pin-out is shown in [Figure 7-5](#). The connector is a male DB-9. See [“Configure the Hardcopy Port” on page 4-73](#) for information on using this port with a printer or plotter.

Figure 7-5

RS-232 Connector Pin-out

PIN #	SIGNAL DESCRIPTION	SIGNAL NAME
1	Data Carrier Detect	CF
2	Receive Data	BB
3	Transmit Data	BA
4	Data Terminal Ready	CD
5	Ground, 0 V	AB
6	Data Set Ready	CC
7	Request to Send	CA
8	Clear to Send	CB
9	Ring Indicator	CE

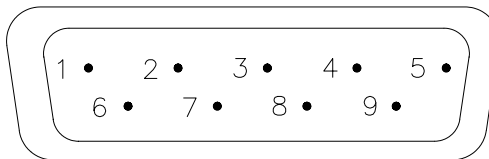

View looking into connector

po623b

**VIDEO OUT
COLOR VGA**

This rear panel connector provides signals to drive an external VGA compatible monitor. The following table describes a VGA compatible monitor, and [Figure 7-6](#) shows the pin-out for the VIDEO OUT connector, looking into the connector.

Table 7-3 **VGA Compatible Monitor Characteristics**

Resolution:	640 × 480
Pixel rate:	25 MHz
Horizontal rate:	31.41 kHz (31.84 μs)
Vertical rate:	59.82 Hz
Video:	analog red, green, blue, 0.714 V p-p, positive, 75 Ω impedance
Sync: ¹	Separate TTL signals for vertical and horizontal sync

1. The analyzer also provides for sync-on-green monitors. See [“Using an External VGA Monitor”](#) on page 4-89.

Figure 7-6 **VIDEO OUT Connector Pin-out**

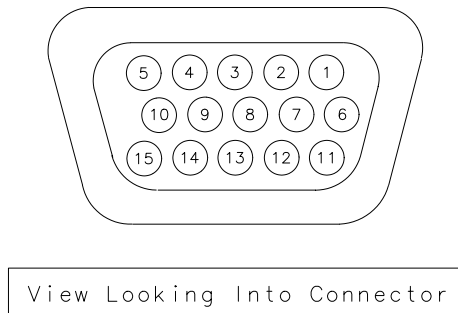

pp61c

Refer to the following table for the signal description of each pin-out.

Pin #	Signal Description	Pin #	Signal Description
1	Red Video	9	N/C (Key)
2	Green Video	10	Digital Ground
3	Blue Video	11	GND (Display ID 0)
4	N/C (Reserved)	12	N/C (Display ID 1)
5	GND (Monitor self-test)	13	Horizontal Sync
6	Red Ground	14	Vertical Sync
7	Green Ground	15	N/C (Reserved)
8	Blue Ground		

See [“Using an External VGA Monitor” on page 4-89](#) for more information on how to synchronize and adjust the display on an external monitor.

DIN KEYBOARD This rear panel connector can be used with an optional keyboard or bar code reader. See [“Using a Keyboard” on page 4-85](#) for more information. Signals are IBM PC/AT compatible.

EXT DET Y-INPUT These rear panel connectors power external detectors and accept input from them for processing and display. Compatible detectors are:

- 86201B
- 86200B

**PROBE POWER
(FUSED)**

This front panel connector provides fused power for active probes and other devices. [Figure 7-7](#) shows the pin-out of the connector looking into the connector.

Figure 7-7 **Probe Power Connector**

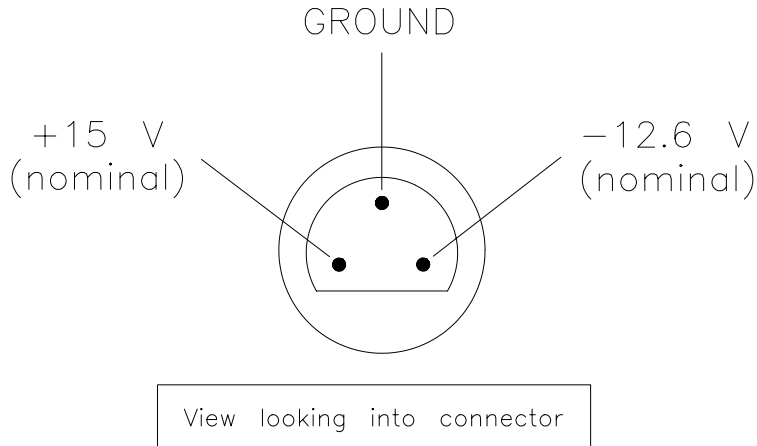

pe624b

The probe power output specifications are:

+15 V supply: $I_{out} = 200 \text{ mA max}$

-12.6 supply: $I_{out} = 150 \text{ mA max}$

Applying loads that result in current levels beyond these specifications can result in improper instrument operation, or damage to the analyzer.

Both outputs are fused with 0.75 Amp fuses, which are located on a circuit board on the inside front panel of the analyzer. The fuses are plastic bi-pin type. The replacement part number for these fuses is 2110-0424.

RF Connectors

PORT 1 and PORT 2

The standard front panel connector used for PORT 1 and PORT 2 is a female type-N 50 Ω connector. When Option 1EC is ordered, this front panel connector is a female type-N 75 Ω connector.

CAUTION

While 50 Ω and 75 Ω type-N connectors are similar in appearance, they are *not* compatible. 75 Ω type-N connectors have a smaller center pin. Connector damage can result if you attach a 50 Ω male connector to a 75 Ω female connector.

To adapt from 50 Ω to 75 Ω , always use a minimum loss pad:

- For adapting from 50 Ω female to 75 Ω female, use an 11852B, Option 004, minimum loss pad.
- For adapting from 75 Ω female to 50 Ω female, use a standard 11852B minimum loss pad.

Display

The analyzer display shows various measurement information. The following illustration shows several locations where information is provided on the screen.

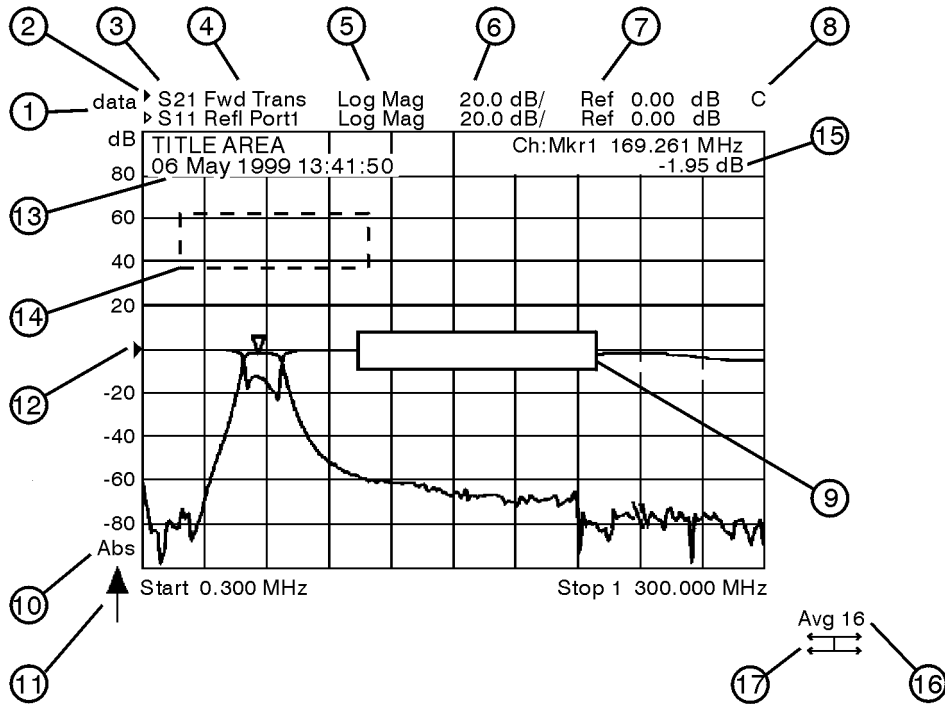

pp630es

Table 7-4

1	The data ? status notation in the upper left corner of the display screen indicates that the analyzer source or receiver parameters have changed since the last complete sweep.
2	The active measurement channel indicator is designated by a solid right arrow (▶). The active measurement channel's data trace and other parameter data is indicated by being brighter than the inactive measurement channel's data.
3	The parameters for both measurement channels always appear at the top of the display in this area.
4	The type of measurement for each measurement channel is displayed here. If a measurement channel is turned off, the display says "Off" here.
5	This is the display format that is selected using the FORMAT key.
6	This is the Scale/Div that is selected using the SCALE key, in units appropriate to the current measurement.
7	This is the reference level. This value is the reference line in Cartesian formats or the outer circle in polar formats. The reference level is selected using the SCALE key.
8	A "C" appears here when a user-defined calibration is in use. If the frequency span has been narrowed, the notation becomes "C?" to indicate that interpolated error correction is on. A "Cx" appears when non-corrected, non-simultaneous measurements are being made (measuring calibration standards, for example). ¹
9	The message area is where you will receive messages from the analyzer from time to time. Most messages appear only for a few moments before disappearing.
10	This area indicates whether the scale is absolute (Abs) or relative (Rel).
11	The sweep indicator appears here in the lower left corner of the display when the analyzer is sweeping at a rate of less than 1.5 s. At sweeptimes above 1.5 s the sweep indicator moves across the screen with the data trace.
12	The reference level for the active measurement channel is indicated by a solid right arrow (▶) adjacent to the graticule on the left.
13	Title and date area.
14	Active entry area: used to enter or adjust values for operating parameters.
15	Marker annotation area.
16	When averaging is turned on, the average indicator appears here.
17	The measurement display icon appears here in the lower right corner of the display to indicate the signal path direction of the current measurement. Refer to "The Measurement Display Icon" on page 3-8 .

1. If a "U" (for uncalibrated) appears here at any time, your instrument will not perform accurate measurements and needs servicing. See [Table 9-10, "Agilent Technologies Sales and Service Offices," in Chapter 9](#) for a list of Agilent Technologies sales and service offices.

Knob

The front panel knob is used to either increase or decrease parameter values, and to give an analog feel to the setting of the values. Any of the values that can be set through the numeric entry pad, or the step keys, can also be set using the knob. However, the rate at which the active parameter varies, for a given amount of knob rotation, is dependent on the parameter that is being controlled.

Power Switch

Figure 7-8 **The Analyzer Power Switch**

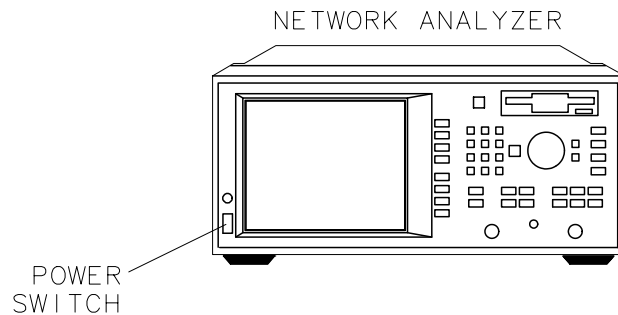

po626b

The power switch selects power to the analyzer to be either on (I) or standby (⏻). The analyzer power switch is located at the bottom left corner of the front panel. When set to standby, the analyzer circuitry is powered off, but a portion of the power supply stays on.

The detachable power cord is the instrument disconnecting device. It disconnects the mains circuits from the mains supply before other parts of the instrument. The front panel switch is only a standby switch and is not a LINE switch (disconnecting device). Alternatively, an externally installed switch or circuit breaker may be used as a disconnecting device.

TIP

When not using the analyzer, leave it plugged in and switched to standby. When in standby, the analyzer supplies power to the non-volatile memory, thereby increasing the life of the internal non-volatile memory battery.

WARNING

Before turning the analyzer on, make sure that it is grounded through the protective conductor of the power cable to a mains power receptacle provided with protective earth contact. Any interruption of the protective grounding conductor inside or outside of the analyzer or disconnection of the protective earth terminal can result in personal injury.

Display Intensity Control

Figure 7-9 **Display Intensity Control**

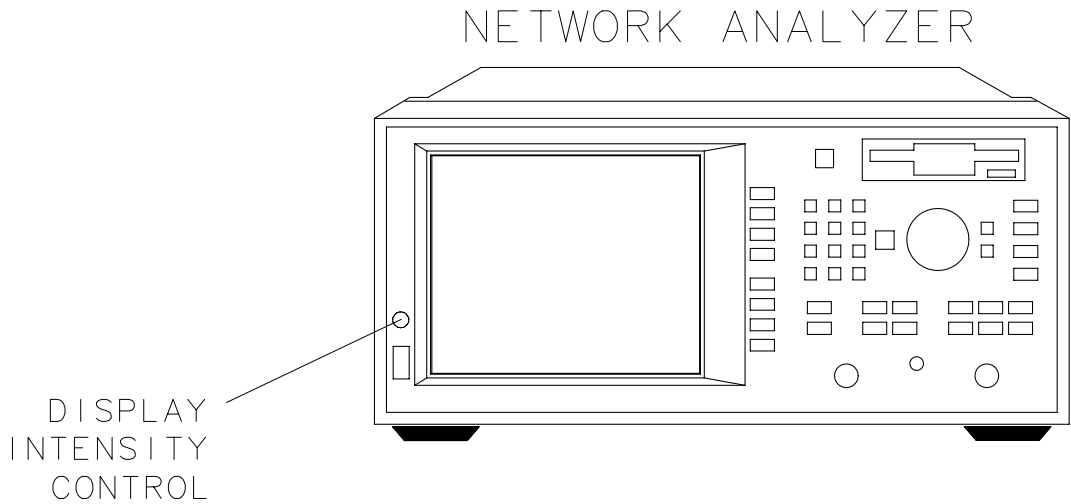

po627b.

The display intensity control adjusts the brightness of the display.

Disk Drive

Figure 7-10 **Disk Drive**

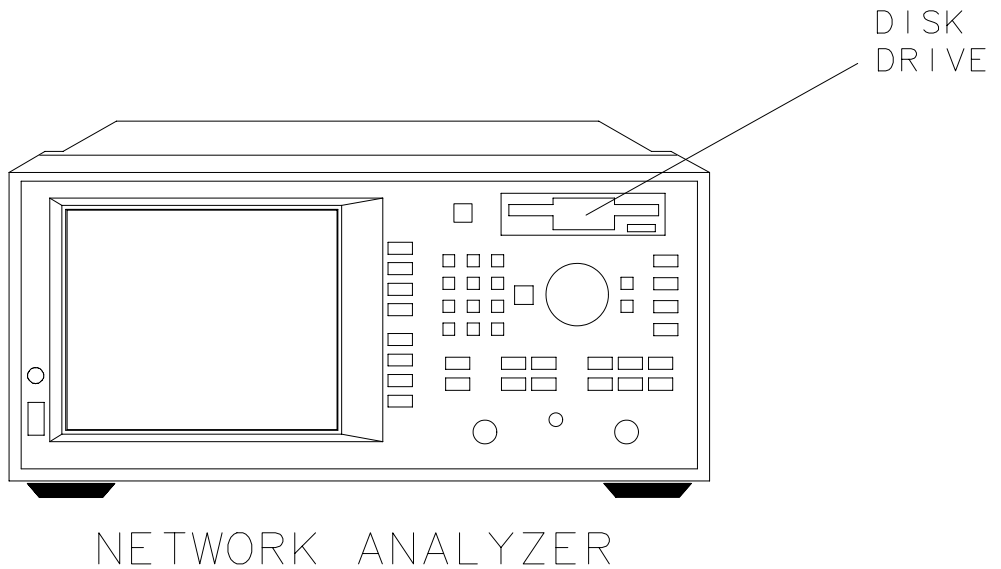

po628b.

The built-in 3.5" disk drive offers permanent information storage capacity. You can use the disk drive to save and recall instrument states, and IBASIC programs. In conjunction with IBASIC, it allows the analyzer to enter a known state or an automated routine at power-on.

The disk drive recognizes double-sided 3.5" disks formatted in DOS, and will utilize both high density (HD) disks (1.44 MB) and 720 KB disks.

The analyzer's firmware and calibration constants can be updated when necessary, using the appropriate disk in this drive. Refer to the *Service Guide* for more information.

Line Module

The line module contains:

- the power cable receptacle
- the line fuse (and an extra fuse)
- the voltage selector switch

Power Cables









The line power cable is supplied in one of several configurations, depending on the destination of the original shipment.

Each instrument is equipped with a three-wire power cable. When connected to an appropriate ac power receptacle, this cable grounds the instrument chassis. The type of power cable shipped with each instrument depends on the country of destination. See for the part numbers of these power cables. Cables are available in different lengths. Check with your nearest Agilent Technologies service center for descriptions and part numbers of cables other than those described in [Figure 7-11](#).

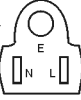
WARNING

This is a Safety Class I product (provided with a protective earthing ground incorporated in the power cord). The mains plug shall only be inserted in a socket outlet provided with a protective earth contact. Any interruption of the protective conductor, inside or outside the instrument, is likely to make the instrument dangerous. Intentional interruption is prohibited.

Figure 7-11 Power Cable and Line (Mains) Plug Part Numbers

Plug Type ^a	Cable Part Number	Plug ^b Description	Length cm (in.)	Cable Color	For Use in Country
 250V	8120-1351	Straight BS 1363A	229 (90)	Mint Gray	Option 900 United Kingdom, Hong Kong, Cyprus, Nigeria, Singapore, Zimbabwe
	8120-1703	90°	229 (90)	Mint Gray	
 250V	8120-1369	Straight AS 3112	210 (79)	Gray	Option 901 Argentina, Australia, New Zealand, Mainland China
	8120-0696	90°	200 (78)	Gray	
 125V	8120-1378	Straight NEMA 5-15P	203 (80)	Jade Gray	Option 903 United States, Canada, Brazil, Colombia, Mexico, Philippines, Saudi Arabia, Taiwan
	8120-1521	90°	203 (80)	Jade Gray	
 125V	8120-4753	Straight NEMA 5-15P	229 (90)	Gray	Option 918 Japan
	8120-4754	90°	229 (90)	Gray	
 250V	8120-1689	Straight CEE 7/VII	200 (78)	Mint Gray	Option 902 Continental Europe, Central African Republic, United Arab Republic
	8120-1692	90°	200 (78)	Mint Gray	
 230V	8120-2104	Straight SEV Type 12	200 (78)	Gray	Option 906 Switzerland
	8120-2296	90°	200 (78)	Gray	
 220V	8120-2956	Straight SR 107-2-D	200 (78)	Gray	Option 912 Denmark
	8120-2957	90°	200 (78)	Gray	
 250V	8120-4211	Straight IEC 83-B1	200 (78)	Mint Gray	Option 917 South Africa, India
	8120-4600	90°	200 (78)	Mint Gray	
 250V	8120-5182	Straight SI 32	200 (78)	Jade Gray	Option 919 Israel
	8120-5181	90°	200 (78)	Jade Gray	

a. E = earth ground, L = line, and N = neutral.

b. Plug identifier numbers describe the plug only. The HP part number is for the complete cable assembly.

form119

The Line Fuse

The line fuse (part number 2110-0709), and a spare, reside within the line module. [Figure 7-12](#) illustrates where the fuses are and how to access them.

Figure 7-12 **Location of Line Fuses**

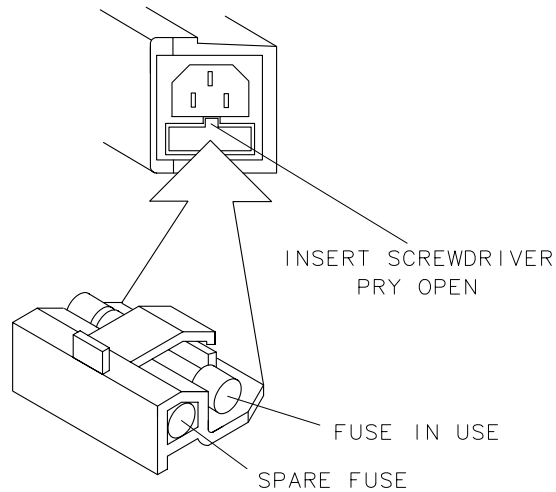

FORMAT48

WARNING

For continued protection against fire hazard replace line fuse only with same type and rating (T 5A 250 V). The use of other fuses or material is prohibited.

The Voltage Selector Switch

Figure 7-13 Voltage Selector Switch Location

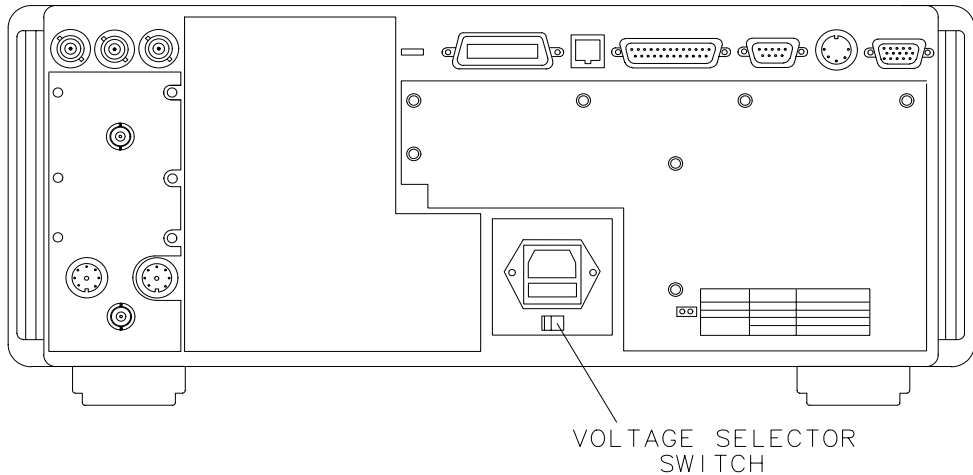

pp68c

Use a screwdriver to set the line voltage selector switch to the proper position (either 110 V or 220 V).

The power source must meet the following requirements:

Table 7-5

Nominal Setting	AC Line Power
115 V	90 to 132 Vac (47 to 63 Hz)
230 V	198 to 264 Vac (47 to 63 Hz)

If the ac line voltage does not fall within these ranges, an autotransformer that provides third wire continuity to ground may be used.

8 **Hardkey/Softkey Reference**

Introduction

This chapter provides a brief description of the analyzer's hardkeys and softkeys. This chapter is arranged alphabetically for ease of use.

NOTE

See the *Service Guide* for a description of service related softkeys.

Numeric Entries



<p>1: ... 8:</p>	<p>Markers number one through eight in the MARKER menu. Pressing any one of these softkeys makes the marker the active marker and (if previously off) turns it on. ">" after the marker number means the marker is the active marker. ":" means the marker is not the active marker; it may be on or off.</p> <p>See "Using Markers" on page 4-3 for an explanation of "active marker," and for more information on using markers.</p>
<p>3.5 mm</p>	<p>Softkey in the cal kit menu of 50 ohm instruments. Selects the type of cal kit as 3.5 mm.</p> <p>See Chapter 6, "Calibrating for Increased Measurement Accuracy," for more information.</p> <p>Access Keys: CAL More Cal Cal Kit</p> <hr/> <p>NOTE By convention, cal kits indicate the sex of the <i>port</i> with which they are used. For example, the default cal kit for the analyzer is type-N <i>female</i> because the front panel RF ports are female (the calibration standards, in turn, have male connectors).</p>
<p>50 Ω</p>	<p>Softkey in the system impedance menu. Selects 50 ohms as the system impedance.</p> <p>Refer to "When to Change the System Impedance" on page 3-13 for more information.</p> <p>Access Keys: CAL More Cal System Z0</p>
<p>75 Ω</p>	<p>Softkey in the system impedance menu. Selects 75 ohms as the system impedance.</p> <p>Refer to "When to Change the System Impedance" on page 3-13 for more information.</p> <p>Access Keys: CAL More Cal System Z0</p>

<p>7-16</p>	<p>Softkey in the cal kit menu of 50 ohm instruments. Selects the type of cal kit as 7-16. This cal kit will work for both male and female connectors.</p> <p>See Chapter 6, “Calibrating for Increased Measurement Accuracy,” for more information.</p> <p>Access Keys: CAL More Cal Cal Kit More Cal Kits</p> <hr/> <p>NOTE By convention, cal kits indicate the sex of the <i>port</i> with which they are used. For example, the default cal kit for the analyzer is type-N <i>female</i> because the front panel RF ports are female (the calibration standards, in turn, have male connectors).</p>
<p>8711A/B Compatible</p>	<p>Softkey in the file format menu. Select this key only if you are saving instrument states that are to be used in older model ("A" or "B") analyzers.</p> <p>See “Saving and Recalling Measurement Results” on page 4-57 for more information.</p> <p>Access Keys: SAVE RECALL Define Save File Format</p>
<p>8711C Compatible</p>	<p>Softkey in the file format menu. Select this key only if you are saving instrument states that are to be used in older model ("C") analyzers.</p> <p>See “Saving and Recalling Measurement Results” on page 4-57 for more information.</p> <p>Access Keys: SAVE RECALL Define Save File Format</p>
<p>8712E Compatible</p>	<p>Softkey in the file format menu. Always select this key, unless you need your file to be compatible with older models ("A," "B," or "C") analyzers.</p> <p>See “Saving and Recalling Measurement Results” on page 4-57 for more information.</p> <p>Access Keys: SAVE RECALL Define Save File Format</p>

8712ES Address	Softkey in the GPIB menu. Sets actual GPIB address of the network analyzer. Default GPIB address is 16. This setting is not affected by PRESET or power-on. Access Keys: SYSTEM OPTIONS GPIB
8712ES IP Address	Softkey in the LAN port setup menu. Allows you to enter the IP address that your network administrator assigned to your analyzer. <i>See The LAN Interface User's Guide Supplement for more information.</i> Access Keys: SYSTEM OPTIONS LAN LAN Port Setup
8714ES Address	Softkey in the GPIB menu. Sets actual GPIB address of the network analyzer. Default GPIB address is 16. This setting is not affected by PRESET or power-on. Access Keys: SYSTEM OPTIONS GPIB
8714ES IP Address	Softkey in the LAN port setup menu. Allows you to enter the IP address that your network administrator assigned to your analyzer. <i>See The LAN Interface User's Guide Supplement for more information.</i> Access Keys: SYSTEM OPTIONS LAN LAN Port Setup

A

<p>A</p>	<p>Softkey in the narrowband internal menu. Selects the tuned receiver measurement of input A.</p> <p>See “Measuring Devices with Your Network Analyzer” on page 3-3 for more information on input A.</p> <p>Access keys: (MEAS 1) or (MEAS 2), More Detection Options Narrowband Internal</p>
<p>A/R</p>	<p>Softkey in the narrowband internal menu. Selects the tuned receiver reflection measurement A/R.</p> <p>See “Measuring Devices with Your Network Analyzer” on page 3-3 for more information on measuring A/R.</p> <p>Access keys: (MEAS 1) or (MEAS 2), More Detection Options Narrowband Internal</p>
<p>Abort</p>	<p>Softkey in the (HARDCOPY) menu. Stops sending data from the network analyzer to the hardcopy device.</p> <hr/> <p>NOTE Hardcopy devices with large buffers may continue to operate for quite a while after this command. To stop such devices immediately, turn off power to the hardcopy device.</p> <hr/>
<p>Abort Kit</p>	<p>Softkey in the modify kit menu. Stops the current calibration kit modification procedure and returns to the cal kit menu.</p> <p>Access Keys: (CAL) More Cal Cal Kit Modify (connector type)</p>
<p>Active Marker Off</p>	<p>Softkey in the marker menu that turns off the active marker and makes the lowest numbered marker (if any) the active marker.</p> <p>See “Using Markers” on page 4-3 for an explanation of "active marker," and for more information on using markers.</p> <p>Access Keys: (MARKER) More Markers</p>

<p>Add Kit Description</p>	<p>Softkey in the mod kit save/recall menu that allows you to enter your own description of a user-defined calibration kit. To enter the description, it is fastest and easiest to use a keyboard connected to the analyzer DIN KEYBOARD connector. If you don't have a keyboard, you can use the analyzer   keys or the front panel knob and the Select Char key to select and enter characters from the top of the analyzer's display. Press Enter when done.</p> <p>See Chapter 6, "Calibrating for Increased Measurement Accuracy," for more information.</p> <p>Access Keys: CAL More Cal Cal Kit Modify (<i>connector type</i>) Mod Kit SaveRecall</p>
<p>Add Limit</p>	<p>Softkey in the limit menu. Displays the menu to add limit lines or points to the limit table.</p> <p>See "Using Limit Testing" on page 4-28 for detailed information on using limit lines.</p> <p>Access Keys: DISPLAY Limit Menu</p>
<p>Add Login User</p>	<p>Softkey in the users setup menu. Displays dialog boxes for entering login user/password pairs to the access list of your analyzer.</p> <p>See <i>The LAN Interface User's Guide Supplement</i> for more information.</p> <p>Access Keys: SYSTEM OPTIONS LAN Login User Setup</p>
<p>Add Max Line</p>	<p>Softkey in the add limit menu. Displays the menu to add a maximum limit line.</p> <p>See "Using Limit Testing" on page 4-28 for detailed information on using limit lines.</p> <p>Access Keys: DISPLAY Limit Menu Add Limit</p>
<p>Add Max Point</p>	<p>Softkey in the add limit menu. Displays the menu to add a maximum limit point.</p> <p>See "Using Limit Testing" on page 4-28 for detailed information on using limit lines.</p> <p>Access Keys: DISPLAY Limit Menu Add Limit</p>

Add Min Line	<p>Softkey in the add limit menu. Displays the menu to add a minimum limit line.</p> <p>See “Using Limit Testing” on page 4-28 for detailed information on using limit lines.</p> <p>Access Keys: DISPLAY Limit Menu Add Limit</p>
Add Min Point	<p>Softkey in the add limit menu. Displays the menu to add a minimum limit point.</p> <p>See “Using Limit Testing” on page 4-28 for detailed information on using limit lines.</p> <p>Access Keys: DISPLAY Limit Menu Add Limit</p>
All Off	<p>Softkey in the MARKER menu that turns off all of the markers, the delta marker, and marker tracking on the active measurement channel.</p> <p>See “Using Limit Testing” on page 4-28 for detailed information on using markers.</p>
Alpha	<p>Formats the real-time internal clock to display the first three letters of the month rather than a number (for example, Mar for March instead of 03).</p> <p>Access keys: SYSTEM OPTIONS System Config Set Clock Clock Format</p>
Alt Sweep on OFF	<p>Softkey in the SWEEP menu. When alternate sweep is toggled ON, the analyzer shows the operation of different instrument states on its two displayed measurement channels. The settings of the two measurement channels can differ: frequency span, detection option type, number of points, system bandwidth, trigger, sweep time. When alternate sweep is off, the preceding settings match. Note: some settings, such as power level, always match.</p>
Amplifier	<p>Softkey in the BEGIN menu. Displays the menu of measurements suitable for amplifier measurements: S_{11}, S_{21}, S_{12}, S_{22}, and power.</p>

Annotation ON off	<p>Softkey in the define graph menu. When annotation is on, printed or plotted hardcopies will contain screen annotation such as the marker readout that appears in the upper right corner of the display. When off, the screen annotation is suppressed from the hardcopy.</p> <p>Access Keys: HARDCOPY Define Hardcopy Define Graph</p>
Annotation Options	<p>Softkey in the more display menu. Displays a menu that allows you to customize the analyzer's display screen by enabling or disabling annotation for the measurement channel, frequency, and markers.</p> <p>See “Customizing the Display” on page 4-45 for more information.</p> <p>Access Keys: DISPLAY More Display</p>
APC-7	<p>Softkey in the cal kit menu of 50 ohm instruments. Selects the type of cal kit as APC-7.</p> <p>See “Calibration Kits” on page 6-23 for more information.</p> <p>Access Keys: CAL More Cal Cal Kit</p>
Aperture (%)	<p>Softkey in the delay aperture menu, which is available when the analyzer is in Delay format.</p> <p>See “Measuring Group Delay” on page 3-70 for information on aperture.</p> <p>Access Keys: AVG Delay Aperture</p>
Aperture (Hz)	<p>Softkey in the delay aperture menu.</p> <p>See “Measuring Group Delay” on page 3-70 for information on aperture.</p> <p>Access Keys: AVG Delay Aperture</p>
Authentication	<p>Softkey in the NFS device setup menu. Displays the authentication menu which allows you to enter a User ID and a Group ID for your NFS remote file system.</p> <p>See <i>The LAN Interface User's Guide Supplement</i> for more information.</p> <p>Access Keys: SYSTEM OPTIONS LAN NFS Device Setup</p>

Auto Feed ON off	<p>Softkey in the define printer and define plotter menus. Toggles the paper autofeed feature on and off. Default is on.</p> <p>Access Keys: HARDCOPY Define Printer or Define Plotter</p>
Automount At Powerup	<p>Softkey in the automount setup menu and the mount NFS device menu. After an NFS device is mounted successfully, select this key to add it to the automount device table. The NFS device will automatically be remounted on powerup of the analyzer.</p> <p>See <i>The LAN Interface User's Guide Supplement</i> for more information.</p> <p>Access Keys: SYSTEM OPTIONS LAN NFS Device Setup Automount Setup or Mount NFS Device</p>
Automount Dev Table	<p>Softkey in the automount setup menu. Displays a table listing the currently automounted NFS devices.</p> <p>See <i>The LAN Interface User's Guide Supplement</i> for more information.</p> <p>Access Keys: SYSTEM OPTIONS LAN NFS Device Setup Automount Setup</p>
Automount Setup	<p>Softkey in the NFS device setup menu. Displays the automount setup menu which allows you to add or remove an NFS device on the automount device table.</p> <p>See <i>The LAN Interface User's Guide Supplement</i> for more information.</p> <p>Access Keys: SYSTEM OPTIONS LAN NFS Device Setup</p>
Autoscale	<p>Softkey in the SCALE menu. Scales the data trace vertically to fit within the graticule area of the display.</p>
Autost	<p>Softkey in the BEGIN menu. Enables the analyzer to search for an IBASIC autostart file (AUTOSTART.BAS). If found, the file is loaded and run. The analyzer first searches for the file in non-volatile RAM and next searches a floppy disk in the built-in disk drive.</p>

<p>Autozero</p>	<p>Softkey in the CAL menu. This softkey is only available when using internal or external broadband detectors. Periodically, this feature compensates for external detector drift due to changes in temperature. When this softkey is selected, the detector(s) are automatically zeroed every five minutes.</p> <hr/> <p>CAUTION Do not use Autozero with an external source. See Manual Zero .</p>
<p>Aux Input</p>	<p>Softkey in the detection options menu. Select this softkey to make very low frequency voltage measurements with the Auxiliary Input, located on the rear panel of the analyzer.</p> <p>See “Making Measurements with the Auxiliary Input” on page 3-68 for more information.</p> <p>Access Keys: MEAS 1 or MEAS 2, More Detection Options</p>
<p>Average Factor</p>	<p>Softkey in the AVG menu. Enters the averaging factor (number) in powers of 2. Acceptable values are: 1, 2, 4, 8, 16, 32, and 64. The default averaging factor is 16, the maximum is 64.</p> <p>See “To Reduce the Receiver Noise Floor” on page 5-10 for more information on how averaging works.</p>
<p>Average on OFF</p>	<p>Softkey in the AVG menu. Toggle to ON if you want to enable the averaging function. Averaging reduces random noise by averaging the measurement data from sweep to sweep.</p> <p>See “To Reduce the Receiver Noise Floor” on page 5-10 for more information on how averaging works.</p>
<p>AVG</p>	<p>Hardkey in the CONFIGURE area. Displays the menu that allows selection of averaging parameters as well as system bandwidth and delay aperture selections.</p> <p>See “To Reduce the Receiver Noise Floor” on page 5-10 for more information on how averaging works.</p>

B

B	<p>Softkey in the narrowband internal menu. Selects the tuned receiver measurement of input B.</p> <p>See “Measuring Devices with Your Network Analyzer” on page 3-3 for more information on input B.</p> <p>Access keys: MEAS 1 or MEAS 2, More Detection Options Narrowband Internal</p>
B*	<p>Softkey in the broadband internal menu. Selects the diode detector measurement of input B*. This is the "power" measurement detector.</p> <p>See “Measuring Devices with Your Network Analyzer” on page 3-3 for more information on input B*.</p> <p>Access keys: MEAS 1 or MEAS 2, More Detection Options Broadband Internal</p>
B*/R*	<p>Softkey in the broadband internal menu. Selects the diode detector transmission measurement of the ratio of input B* (broadband transmitted power) to input R* (broadband reference signal).</p> <p>See “Measuring Devices with Your Network Analyzer” on page 3-3 for more information on ratioed measurement B*/R*.</p> <p>Access Keys: MEAS 1 or MEAS 2, More Detection Options Broadband Internal</p>
B/R	<p>Softkey in the narrowband internal menu. Selects the tuned receiver measurement of the ratio of input B (transmitted power) to input R (reference signal).</p> <p>See “Measuring Devices with Your Network Analyzer” on page 3-3 for more information on ratioed measurement B/R.</p> <p>Access keys: MEAS 1 or MEAS 2, More Detection Options Narrowband Internal</p>

Bandwidth	Softkey in the marker search menu. Automatically calculates -3 dB (default) or other user-specified bandwidth, center frequency, and Q of a bandpass filter. See “Using Markers” on page 4-3 for more information. Access Keys: (MARKER) Marker Search
Baud Rate	Softkey in the select copy port menu. Sets the transmission baud rate of the analyzer for serial devices. Make sure the rate you set matches the requirement of the output device (see its manual for details). Access keys: (HARDCOPY) Select Copy Port
Beeper Volume	Softkey in the system configuration menu. Sets the analyzer beeper volume from off (0) to high (100). The default is 90. Access keys: (SYSTEM OPTIONS) System Config
(BEGIN)	Hardkey located to the left of the disk drive. An appropriate place to begin measuring any of the four types of devices in the begin menu. Recommended for one channel measurements. See “Using the BEGIN Key to Make Measurements” on page 3-15 for more information.
Begin Frequency	Softkey used to define a limit line. See “Using Limit Testing” on page 4-28 for more information. Access Keys: (DISPLAY) Limit Menu Add Limit Add Max Line or Add Min Line
Begin Limit	Softkey used to define a limit line. See “Using Limit Testing” on page 4-28 for more information. Access Keys: (DISPLAY) Limit Menu Add Limit Add Max Line or Add Min Line
BOOTP on OFF	Softkey in the BOOTP setup menu. When toggled to ON, enables a BOOTP request when the analyzer boots up. Default setting is OFF. <i>See The LAN Interface User's Guide Supplement for more information.</i> Access Keys: (SYSTEM OPTIONS) LAN BOOTP Setup

BOOTP Setup	<p>Softkey in the LAN menu. Displays the BOOTP setup menu which allows you to set up the analyzer as a BOOTP client.</p> <p>See <i>The LAN Interface User's Guide Supplement</i> for more information.</p> <p>Access Keys: SYSTEM OPTIONS LAN</p>
Broadband External	<p>Softkey in the detection options menu. Displays the menu to select measurements made with external broadband detectors: X, Y, X/Y, Y/X, Y/R*.</p> <p>Access Keys: MEAS 1 or MEAS 2, More Detection Options</p>
Broadband Internal	<p>Softkey in the detection options menu. Displays the menu to select measurements made with internal broadband detectors: B*, R*, or B*/R*.</p> <p>Access Keys: MEAS 1 or MEAS 2, More Detection Options</p>
Broadband Passive	<p>Softkey in the BEGIN menu. Sets up the analyzer to make S_{11}, S_{21}, S_{12}, or S_{22} measurements of passive devices such as cables.</p>

C

C0	<p>Softkey in the open menu. Allows you to modify the C₀ characteristic of the open calibration standard in your calibration kit.</p> <p>See “Calibration Kits” on page 6-23 for more information.</p> <p>Access Keys: CAL More Cal Cal Kit Modify (connector type) Open</p>
C1	<p>Softkey in the open menu. Allows you to modify the C₁ characteristic of the open calibration standard in your calibration kit.</p> <p>See “Calibration Kits” on page 6-23 for more information.</p> <p>Access Keys: CAL More Cal Cal Kit Modify (connector type) Open</p>
C2	<p>Softkey in the open menu. Allows you to modify the C₂ characteristic of the open calibration standard in your calibration kit.</p> <p>See “Calibration Kits” on page 6-23 for more information.</p> <p>Access Keys: CAL More Cal Cal Kit Modify (connector type) Open</p>
C3	<p>Softkey in the open menu. Allows you to modify the C₃ characteristic of the open calibration standard in your calibration kit.</p> <p>See “Calibration Kits” on page 6-23 for more information.</p> <p>Access Keys: CAL More Cal Cal Kit Modify (connector type) Open</p>
Cable	<p><i>(Option 100 only)</i> Softkey in the BEGIN menu. Sets up the analyzer for fault location and SRL measurements. See your <i>Option 100 User's Guide Supplement</i> for information.</p>
CAL	<p>Hardkey in the CONFIGURE area. Displays the calibration menu options for the current measurement mode.</p> <p>See Chapter 6 for information on calibrating the analyzer.</p>

Cal Kit	<p>Softkey in the more cal menu. Allows selection of type of cal kit: Type-N female (default), Type-N male, 3.5 mm (for use with 50 Ω systems), Type-F (for use with 75 Ω systems), APC-7 (for use with 50 Ω systems), or user-defined (cal kit A or cal kit B).</p> <hr/> <p>NOTE By convention, cal kits indicate the sex of the <i>port</i> with which they are used. For example, the default cal kit for the analyzer is type-N <i>female</i> because the front panel RF ports are female (the calibration standards, in turn, have male connectors).</p> <hr/> <p>See Chapter 6 for more information on calibration kits.</p> <p>Access Keys: CAL More Cal</p>
Cal on OFF	<p>Softkey in the define save menu. Toggle to ON if you want to save the active measurement calibration along with the current instrument state.</p> <p>See “Saving and Recalling Measurement Results” on page 4-57 for information on saving instrument states and measurement results to files.</p> <p>Access Keys: SAVE RECALL Define Save</p>
Cancel	<p>Softkey available when editing titles, file names, directory names, and IBASIC programs from the front panel of the analyzer. Cancels the editing mode and any changes that were made but not saved.</p>
Center	<p>Softkey in the FREQ menu. Sets the center frequency of the internal RF source and changes screen annotation to center and span, as opposed to start and stop.</p>
Change Directory	<p>Softkey in the directory utilities menu. Used to change directories on an internal or external DOS storage device.</p> <p>See “To Use Directory Utilities” on page 4-67 for more information.</p> <p>Access Keys: SAVE RECALL File Utilities Directory Utilities</p>
Clear Entry	<p>Softkey available when editing titles, file names, directory names, and IBASIC programs from the front panel of the analyzer. Clears the entire title, name, or line if pressed.</p>

Clear Program	<p>Softkey in the IBASIC utilities menu. Clears (erases) the current IBASIC program from internal memory.</p> <p>See the <i>HP Instrument BASIC User's Handbook Supplement</i> for more information.</p> <p>Access Keys: SYSTEM OPTIONS IBASIC Utilities</p>
Clock Format	<p>Softkey in the set clock menu. Determines how the date and time are displayed when they are turned on.</p> <p>Date abbreviations:</p> <ul style="list-style-type: none"> • YYYY stands for year. • MM stands for month. • DD stands for day. <p>Time abbreviations:</p> <ul style="list-style-type: none"> • HH stands for hour, 24 hour mode. • MM stands for minute. <p>In numeric format, the month is displayed by number (for example, March is 03). In alpha format, the first three letters of the month are displayed (for example, Mar).</p> <p>See Title+Clk ON off and Set Clock in this chapter for more information on viewing and setting the internal clock.</p> <p>Access Keys: SYSTEM OPTIONS System Config Set Clock</p>
Clock Off	<p>Softkey in the title and clock menu. Suppresses display of clock in the title area.</p> <p>Access Keys: DISPLAY More Display Title and Clock</p>
Color	<p>Softkey in the define printer and define plotter menus. Used to define the printer or plotter as a multi-color device as opposed to a one color (monochrome) device.</p> <p>See “Connecting and Configuring Printers and Plotters” on page 4-70 for more information.</p> <p>Access Keys: HARDCOPY, Define Printer or Define Plotter</p>

Color Options	<p>Softkey in the more display menu. Allows you to customize the colors on an external VGA monitor connected to the rear panel VIDEO OUT connector.</p> <p>See “Using an External VGA Monitor” on page 4-89 for more information.</p> <p>Access Keys: DISPLAY More Display</p>
Confirm Password	<p>Softkey in the add login user menu. Displays a dialog box for confirming a password to be added to the access list of your analyzer.</p> <p>See <i>The LAN Interface User's Guide Supplement</i> for more information.</p> <p>Access Keys: SYSTEM OPTIONS LAN Login User Setup Add Login User</p>
Configure VOL_RAM	<p>Softkey in the select disk menu. Displays the menu to modify the memory allocation for the internal volatile RAM disk.</p> <p>Access Keys: SAVE RECALL Select Disk</p>
Continue	<p>Softkey in the IBASIC menu. Restarts a program that has been paused.</p> <p>See the <i>HP Instrument BASIC User's Handbook and Supplement</i> for more information on using IBASIC.</p> <p>Access Keys: SYSTEM OPTIONS IBASIC</p>
Continuous	<p>Softkey in the trigger menu. In the continuous mode, the analyzer is triggered continuously, beginning its next sweep at the conclusion of the current sweep. Continuous is the default trigger mode.</p> <p>Access Keys: MENU Trigger</p>
Conversion Loss	<p>Softkey in the mixer menu and measurement menus, for measuring frequency translating devices. Selects a broadband internal transmission measurement.</p> <p>See “Measuring Conversion Loss” on page 3-62 for more information.</p> <p>Access Keys: BEGIN Mixer or MEAS 1 More or MEAS 2 More</p>

Copy All Files	<p>Softkey in the file utilities menu. Used to copy files.</p> <p>See “Other File Utilities” on page 4-65 in for more information.</p> <p>Access Keys: SAVE RECALL File Utilities</p>
Copy File	<p>Softkey in the file utilities menu. Used to copy files.</p> <p>See “Other File Utilities” on page 4-65 for more information.</p> <p>Access Keys: SAVE RECALL File Utilities</p>
Copy to 3.5” Disk	<p>Softkey in the copy file menu. Used to select the analyzer's built-in disk drive as the destination drive for copying of files. Displays the character entry menu to rename file (if desired) prior to copying.</p> <p>Access Keys: SAVE RECALL File Utilities , Copy File or Copy All Files</p>
Copy to NonVol RAM	<p>Softkey in the copy file menu. Used to select the analyzer's internal non-volatile RAM as the destination drive for copying of files. Displays the character entry menu to rename the file (if desired) prior to copying.</p> <p>Access Keys: SAVE RECALL File Utilities , Copy File or Copy All Files</p>
Copy to Vol RAM	<p>Softkey in copy file menu. Used to select the analyzer's internal volatile RAM as the destination drive for copying of files. Displays the character entry menu to rename file (if desired) prior to copying.</p> <p>Access Keys: SAVE RECALL File Utilities , Copy File or Copy All Files</p>
CRT Adjust	<p>Softkey in the system configuration menu. Displays the menu to set the external CRT position and timing parameters for best image. These settings are not affected by presetting the analyzer.</p> <hr/> <p>NOTE These adjustments also affect the internal CRT of the analyzer.</p> <hr/> <p>See “Using an External VGA Monitor” on page 4-89 for more information.</p> <p>Access Keys: SYSTEM OPTIONS System Config</p>

Current Size	<p>Softkey in the configure VOL_RAM disk menu. Displays a message box that shows the total memory available and the current memory allocation for the internal volatile RAM disk.</p> <p>Access Keys: SAVE RECALL Select Disk Configure VOL_RAM</p>
Custom Colors	<p>Softkey in the color options menu. Accesses the menu that allows you to customize the colors on your external monitor, or to customize the greyscale on the analyzer's internal display.</p> <p>See “Using an External VGA Monitor” on page 4-89 for more information.</p> <p>Access Keys: DISPLAY More Display Color Options</p>
CW	<p>Softkey in the FREQ menu. Selects CW (continuous wave, single frequency) source operation.</p>

D

Data	Softkey in the DISPLAY menu. Displays the current measurement data trace.
Data and Memory	Softkey in the DISPLAY menu. Displays both the current data and memory traces, with identical scaling and format. You must have selected Data->Mem first for this key to function. <div style="border: 1px solid black; padding: 5px;"> CAUTION Use care in interpreting memory trace values. The memory trace may have been stored under conditions different from the current measurement trace. </div>
Data on OFF	Softkey in the define save menu. Toggle to ON if you want to save the current measurement data. Data can be saved by itself or with the instrument state (Inst State ON off) and current calibration (Cal on OFF). Access Keys: SAVE RECALL Define Save
Data/Mem	Softkey in the DISPLAY menu. Divides current trace data by data in memory. For this key to function, you must first have selected Data->Mem to store a data trace in memory.
Data->Mem	Softkey in the DISPLAY menu. Stores the active data trace in the memory of the active measurement channel.
DD-MM-YYYY HH:MM	Softkey in the clock format menu. Formats the real-time internal clock to display time as Day-Month-Year Hour:Minute. See ClockFormat on page 8-17 for more information on clock format. Access Keys: SYSTEM OPTIONS System Config Set Clock Clock Format

<p>Default</p>	<p>Softkey in the user TTL config menu. Pressing this softkey configures the rear panel USER TTL IN/OUT connector for general purpose I/O use with IBASIC and SPCI commands. This connector can also be configured for softkey sequencing using an external switch, and as a sweep out connector.</p> <p>See "User-Defined TTL Input/Output" in the <i>Automating Measurements User's Guide Supplement</i>, and "Analyzer Connectors—Rear Panel BNC Connectors" on page 7-4 for more information.</p> <p>Access Keys: SYSTEM OPTIONS System Config User TTL Config</p>
<p>Default 1-Port</p>	<p>Softkey in the CAL menu and the one-port reflection cal menu when in S_{11}, or S_{22} (reflection) measurement mode. Use this key to recall a one-port calibration that was performed at the factory or during servicing. Corrects for directivity, source match, and frequency response errors.</p> <p>See Chapter 6 for more information on calibrating the analyzer.</p>
<p>Default 2</p>	<p>Softkey in the color options menu. Sets the external VGA monitor colors to the Default 2 setting.</p> <p>See "Using an External VGA Monitor" on page 4-89 for more information.</p> <p>Access Keys: DISPLAY More Display Color Options</p>
<p>Default 2-Port</p>	<p>Softkey in the CAL menu and the two-port cal menu when in S_{11}, S_{21}, S_{12}, or S_{22} (reflection or transmission) measurement mode. Use this key to recall a two-port calibration that was performed at the factory or during servicing. Corrects for directivity, source match, load match and frequency response errors. Also corrects for crosstalk errors when the Isolation on OFF key is toggled to ON.</p> <p>See Chapter 6 for more information on calibrating the analyzer.</p>

Define Graph	<p>Softkey in the define hardcopy menu. Displays the menu to define which parts of the graph are to be printed or plotted: trace data, graticule, annotation, marker symbol, title and clock, or combinations.</p> <p>See “Printing and Plotting Measurement Results” on page 4-80.</p> <p>Access Keys: HARDCOPY Define Hardcopy</p>
Define Hardcopy	<p>Softkey in the HARDCOPY menu. Displays the menu to define the hardcopy in terms of information to be copied. Default setting is Graph Only.</p> <p>See “Printing and Plotting Measurement Results” on page 4-80.</p>
Define PCL5	<p>Softkey in the HARDCOPY menu. Displays the menu to define a PCL5 printer in terms of color, orientation, autofeed, and margins.</p> <p>See “Connecting and Configuring Printers and Plotters” on page 4-70 for more information.</p>
Default Pen Colors	<p>Softkey in the set pen numbers menu. Resets the plotter pen number assignments to their default values.</p> <p>See “Define the Printer or Plotter Settings” on page 4-75 for default values.</p> <p>Access Keys: HARDCOPY Define Plotter Set Pen Numbers</p>
Define Plotter	<p>Softkey in the HARDCOPY menu. Displays the menu to define the plotter in terms of color, pen numbers, and autofeed.</p> <p>See “Connecting and Configuring Printers and Plotters” on page 4-70 for more information.</p>
Define Printer	<p>Softkey in the HARDCOPY menu. Displays the menu to define the printer in terms of color, orientation, autofeed, resolution, and margins.</p> <p>See “Connecting and Configuring Printers and Plotters” on page 4-70 for more information.</p>

Default Response	<p>Softkey in the CAL menu and the response cal menu when in S_{21} or S_{12} (transmission) measurement mode. Use this key to recall a response calibration that was performed at the factory or during servicing. Corrects for frequency response errors.</p> <p>See Chapter 6 for more information.</p>
Define Save	<p>Softkey in the SAVE RECALL menu. Displays the menu to save the instrument state, measurement calibration, measurement data, or combinations. Allows the choice of saving trace data in ASCII format for output to spreadsheets. ASCII data is compatible with Lotus 1-2-3 and Touchstone formats.</p> <p>See “Saving and Recalling Measurement Results” on page 4-57 for more information.</p>
Delay	<p>Softkey in the open, short, load, and through menus. Allows you to modify the delay characteristic of the open, short, load, or through calibration standards in your calibration kit.</p> <p>See “Calibration Kits” on page 6-23 for more information.</p> <p>Access Keys: CAL More Cal Cal Kit Modify (connector type) , Open or Short or Load or Thru</p>
Delay Aperture	<p>Softkey in the AVG menu. Sets the aperture in Hz or % for group delay measurements.</p>
Delete All Files	<p>Softkey in the file utilities menu. Deletes all files in the current directory. Before the files are deleted, you will be asked to confirm this selection. Also deletes empty directories on DOS disks.</p> <p>See “Other File Utilities” on page 4-65 for more information.</p> <p>Access Keys: SAVE RECALL File Utilities</p>
Delete All Limits	<p>Softkey in the delete limit menu. Deletes all of the limit lines in the limit line table. Asks for confirmation before deletion occurs.</p> <p>See “Using Limit Testing” on page 4-28 for more information on using limit lines.</p> <p>Access Keys: DISPLAY Limit Menu Delete Limit</p>

Delete All Users	<p>Softkey in the users setup menu. Displays a dialog box for deleting all users from the access list of your analyzer.</p> <p>See <i>The LAN Interface User's Guide Supplement</i> for more information.</p> <p>Access Keys: SYSTEM OPTIONS LAN Login User Setup</p>
Delete Char	<p>Softkey used for editing titles, file names, directory names, and IBASIC programs.</p>
Delete File	<p>Softkey in the file utilities menu. Deletes the file that is highlighted.</p> <p>See "Other File Utilities" on page 4-65 for more information on file utilities.</p> <p>Access Keys: SAVE RECALL File Utilities</p>
Delete Limit	<p>Softkey in the limit menu. Displays the menu to delete one segment (or point) of a limit line or all limits.</p> <p>See "Using Limit Testing" on page 4-28 for more information on limit lines.</p> <p>Access Keys: DISPLAY Limit Menu</p>
Delete Line	<p>Softkey in the edit menu of IBASIC. Allows deletion of one line of code at a time.</p> <p>Access Keys: SYSTEM OPTIONS IBASIC Edit</p>
Delete Login User	<p>Softkey in the users setup menu. Displays dialog boxes for deleting login user/password pairs from the access list of your analyzer.</p> <p>See <i>The LAN Interface User's Guide Supplement</i> for more information.</p> <p>Access Keys: SYSTEM OPTIONS LAN Login User Setup</p>
Delta Mkr on OFF	<p>Softkey in the marker functions menu. Toggle to ON if you want to make the active marker the delta marker or reference point.</p> <p>See "To Use Delta (D) Marker Mode" on page 4-24 for more information.</p> <p>Access Keys: MARKER Marker Functions</p>

Detection Options	<p>Softkey in the meas 1 more and meas 2 more menus. Selects measurement type: narrowband or broadband internal, broadband external or aux input.</p> <p>See “Measuring Devices with Your Network Analyzer” on page 3-3 for more information on detection modes.</p> <p>Access Keys: MEAS 1 or MEAS 2, More</p>
Diagnostic Utilities	<p>Softkey in the LAN port setup menu. Displays the menu to set the IP address to ping and to perform ping.</p> <p>See <i>The LAN Interface User's Guide Supplement</i> for more information.</p> <p>Access Keys: SYSTEM OPTIONS LAN LAN Port Setup</p>
Directory Utilities	<p>Softkey in the file utilities menu. Displays the menu to change, make, or remove directories on DOS disks.</p> <p>See “To Use Directory Utilities” on page 4-67 for more information.</p> <p>Access Keys: SAVE RECALL File Utilities</p>
Disp Freq Resolution	<p>Softkey in the FREQ menu. Selects one of the displayed frequency resolutions: MHz, kHz, or Hz. For example, a frequency of 1,234,567 Hz can be displayed as: 1 MHz (note rounding down), 1.235 MHz (note rounding up), or 1.234 567 MHz. Default is kHz.</p>
DISPLAY	<p>Hardkey in the CONFIGURE area of the front panel. Displays the menu with selections concerning type of data to be displayed, split or full screen, title and limit lines.</p>
Display User List	<p>Softkey in the users setup menu. Displays a table that lists all of the login user names on the access list of your analyzer.</p> <p>See <i>The LAN Interface User's Guide Supplement</i> for more information.</p> <p>Access Keys: SYSTEM OPTIONS LAN Login User Setup</p>

Distance	<i>(Option 100 only)</i> Softkey available under the MENU key and the add max point and add min point menus. Used to perform fault location measurements. See your <i>Option 100 User's Guide Supplement</i> for information.
Dither	<p>Softkey in the spur avoid options menu. When selected, shifts spurs which may be visible in low level measurements.</p> <p>See “Reducing Trace Noise” on page 5-12 ifor more information.</p> <hr/> <p>CAUTION The measurement calibration must be performed with the same spur avoid option used in the measurement or your results may be invalid.</p> <hr/> <p>Access Keys: MENU Spur Avoid Options</p>
DTR/DSR	<p>Softkey in the select copy port menu. A hardware handshake for some serial devices. Toggles with Xon/Xoff .</p> <p>Access Keys: HARDCOPY Select Copy Port</p>

E

Edit	<p>Softkey in the IBASIC menu. Displays the IBASIC edit menu and a rudimentary word and character editor.</p> <p>See the <i>HP Instrument BASIC User's Handbook Supplement</i> for more information.</p> <p>Access Keys: (SYSTEM OPTIONS) IBASIC</p>
Edit Limit	<p>Softkey in the limit menu. Displays the menu to change the frequency or amplitude of previously entered limits, or add a data trace marker.</p> <p>Access Keys: (DISPLAY) Limit Menu</p>
Edit Limit (Min/Max)	<p>Softkey in the mkr limits menu. Displays a menu to set the maximum and minimum limits on the selected marker limit test.</p> <p>See “To Use Marker Limit Functions” on page 4-32 for more information.</p> <p>Access Keys: (DISPLAY) Limit Menu Mkr Limits</p>
Electrical Delay	<p>Softkey in the (SCALE) menu. Adjusts the electrical delay to balance the phase of the DUT. It simulates a variable length, lossless transmission line, which can be added to or removed from a receiver input to compensate for interconnecting cables, etc. This function is similar to the mechanical or analog "line stretchers" of other network analyzers. Delay is annotated in units of time with secondary labeling in distance for the current velocity factor.</p>
End Frequency	<p>Softkey in the max line and min line menus. Sets the end (or stop) frequency of a limit line.</p> <p>See “Using Limit Testing” on page 4-28 for more information on limit lines.</p> <p>Access Keys: (DISPLAY) Limit Menu Add Limit , Add Max Line or Add Min Line</p>

End Limit	<p>Softkey in the max line and min line menus. Sets the end (or stop) amplitude (height) of a limit line.</p> <p>See “Using Limit Testing” on page 4-28 for more information on limit lines.</p> <p>Access Keys: DISPLAY Limit Menu Add Limit , Add Max Line or Add Min Line</p>
End Line #	<p>Softkey in the secure menu that is used with the IBASIC feature of the instrument.</p> <p>See the <i>HP Instrument BASIC User's Handbook</i> for information on the secure function.</p> <p>Access Keys: SYSTEM OPTIONS IBASIC Utilities Secure</p>
Enhanced Response	<p>Softkey in the response cal menu when in S_{21} or S_{12} (transmission) measurement mode. Select this key to perform a user-defined enhanced response calibration. Restores a previous enhanced response calibration if current analyzer parameters are compatible with those used during the previous calibration. Corrects for frequency response and source match errors.</p> <p>See “Measuring S_{21} Forward Transmission using an Enhanced Response Calibration” on page 3-42 for more information.</p> <p>Access Keys: CAL User Response</p>
Enter Line 1	<p>Softkey in the title and clock menu. Displays the menu to edit the screen title on line 1 of the display. Maximum number of characters is 36.</p> <p>Access Keys: DISPLAY More Display Title and Clock</p>
Enter Line 2	<p>Softkey in the title and clock menu. Displays the menu to edit the screen title on line 2 of the display. Maximum number of characters is 36.</p> <p>Access Keys: DISPLAY More Display Title and Clock</p>

Ethernet Address	<p>Softkey in the LAN port setup menu. Displays the Ethernet address, which is a 48-bit number assigned at the factory to be used to identify a machine on the network. The Ethernet address cannot be changed.</p> <p>See <i>The LAN Interface User's Guide Supplement</i> for more information.</p> <p>Access Keys: (SYSTEM OPTIONS) LAN LAN Port Setup</p>
Expand on OFF	<p>Softkey in the more display menu. Toggle to ON if you want to expand the measurement display to the full screen size and eliminate all annotation except marker annotation.</p> <p>See “Expanding the Displayed Measurement” on page 4-52 for more information.</p> <p>Access Keys: (DISPLAY) More Display</p>
Ext Ref on OFF	<p>Softkey in the source (MENU). Toggle to ON if you want to set the network analyzer to use the external 10 MHz signal as the frequency standard. When the Ext Ref feature is toggled ON and a signal is not present at the EXT REF IN connector, the network analyzer will not sweep. Default is OFF.</p> <p>NOTE _____ The external reference should be disconnected from the EXT REF IN or power reduced when not in use.</p>
External Point	<p>Softkey in the trigger source menu. Enables the analyzer to sweep to the next (frequency) point when externally triggered through the EXT TRIG IN/OUT rear panel connector. The analyzer sweeps one point per trigger.</p> <p>Access Keys: (MENU) Trigger Trigger Source</p>
External Sweep	<p>Softkey in the trigger source menu. Enables the analyzer to begin one complete sweep when externally triggered.</p> <p>Access Keys: (MENU) Trigger Trigger Source</p>

F

Factory Default	<p>Softkey in the color options menu. Sets the external VGA monitor colors to the factory default.</p> <p>See “Using an External VGA Monitor” on page 4-89 for more information.</p> <p>Access Keys: (DISPLAY) More Display Color Options</p>
Factory Preset	<p>Softkey in the (PRESET) menu. Returns the analyzer to a factory preset state. See Chapter 11, “Factory Preset State and Memory Allocation,” for a complete list of factory preset-state default parameters.</p>
FastRecall on OFF	<p>Softkey in the (SAVE RECALL) menu. Toggle to ON if you want to enable the fast recall feature.</p> <p>See “To Recall from a Floppy Disk or Internal Memory” on page 4-62 for more information.</p>
	<p><i>(Option 100 only)</i> Softkey in the cable or measurement menus. Sets up the analyzer to perform fault location measurements. See your <i>Option 100 User's Guide Supplement</i> for information.</p> <p>Access Keys: (BEGIN) Cable or (MEAS 1) More or (MEAS 2) More</p>
Fault Loc Frequency	<p><i>(Option 100 only)</i> Softkey in the (FREQ) menu. Used when making fault location measurements. See your <i>Option 100 User's Guide Supplement</i> for information.</p>
Fault Window	<p><i>(Option 100 only)</i> Softkey in the (AVG) menu. Used when making fault location measurements. See your <i>Option 100 User's Guide Supplement</i> for information.</p>

<p>File Format</p>	<p>Softkey in the define save menu. Allows you to choose between saving files in a format compatible with "C" model analyzers only, "A" and "B" model analyzers only, or "E" model analyzers only.</p> <p>See "Saving and Recalling Measurement Results" on page 4-57 for more information.</p> <p>Access Keys: SAVE RECALL Define Save</p>
<p>File Type bin ASCII</p>	<p>Softkey in the programs menu. This key is used to select how the IBASIC program is saved to disk. It can be saved in either binary or ASCII format.</p> <p>ASCII Save a program in ASCII format for ease of transportability. Programs saved in ASCII format can be read by any HP BASIC computer or instrument running IBASIC.</p> <p>bin(ary) Binary format is specific to this family of analyzers (8712ES and 8714ES). A program saved in binary format is not readable by an IBASIC computer or other instruments running IBASIC.</p> <p>Binary format, however, is required if you are going to use the LOADSUB keyword.</p> <p>See the <i>Instrument BASIC User's Handbook Supplement</i> for more information on saving programs.</p> <p>Access Keys: SAVE RECALL Programs</p>
<p>File Utilities</p>	<p>Softkey in the SAVE RECALL menu. Displays the menu to rename, delete, or copy files, to format a disk or memory, and to change or make directories.</p> <p>See "Other File Utilities" on page 4-65 for more information.</p>
<p>Filter</p>	<p>Softkey in the BEGIN menu. Sets up the analyzer for S_{11} or S_{21} measurements of filters.</p> <p>See "Using the BEGIN Key to Configure Measurements" on page 3-17 for more information.</p>

Fine 15 Hz	<p>Softkey in the system bandwidth menu. This is the narrowest system bandwidth available. (Medium wide is the default system bandwidth.)</p> <p>See Chapter 5 for information on how system bandwidth can affect your measurements.</p> <p>Access Keys: AVG System Bandwidth</p>
Flatness	<p>Softkey in the marker math menu. Calculates the flatness of a user-defined trace segment.</p> <p>See “To Use Marker Math Functions” on page 4-18 for more information.</p> <p>Access Keys: MARKER Marker Functions Marker Math</p>
FORMAT	<p>Hardkey in the CONFIGURE area. Pressing this key displays a menu of choices for the display format of your measurement.</p> <p>The choices available are: Log Mag, Lin Mag, SWR, Delay, Phase, Smith Chart, Polar, Real, Imaginary, and Impedance Magnitude. For more information on each of these choices, see its entry in this chapter.</p>
Format 3.5” Disk	<p>Softkey in the format disk menu. Formats a disk in the analyzer’s built-in disk drive in DOS format.</p> <p>See “Formatting a Floppy Disk” on page 4-69 for more information.</p> <p>Access Keys: SAVE RECALL File Utilities Format Disk Menu</p>
Format Disk Menu	<p>Softkey in the file utilities menu. Displays the format disk menu to select either the internal non-volatile memory, internal volatile memory, or 3.5” floppy disk (in the analyzer’s built-in disk drive).</p> <p>Access Keys: SAVE RECALL File Utilities</p>
Format NonVol RAM	<p>Softkey in the format disk menu. Formats the internal non-volatile RAM disk.</p> <hr/> <p>CAUTION Formatting the internal non-volatile RAM disk erases all existing files and directories on the disk.</p> <hr/> <p>Access Keys: SAVE RECALL File Utilities Format Disk Menu</p>

Format Vol RAM	<p>Softkey in the format disk menu. Formats the internal volatile RAM disk.</p> <hr/> <p>CAUTION Formatting the internal volatile RAM disk erases all existing files and directories on the disk.</p> <hr/> <p>Access Keys: (SAVE RECALL) File Utilities Format Disk Menu</p>
(FREQ)	<p>Hardkey in the SOURCE area. Displays the frequency menu which allows you to enter the frequency range for your measurement. Also allows you to change the resolution of the displayed frequency.</p> <p>See “Entering Measurement Parameters” on page 2-4 for an example of how to enter frequency range.</p>
Freq Annot ON off	<p>Softkey in the annotation options menu. Toggle ON if you want to view the frequency annotation at the bottom of the display.</p> <p>See “Customizing the Display” on page 4-45 for more information.</p> <p>Access Keys: (DISPLAY) More Display Annotation Options</p>
Frequency	<p>Softkey in the add max point and add min point menus. Sets the frequency of a limit point.</p> <p>See “To Create a Single Point Limit” on page 4-32 for an example of how to set a limit point.</p> <p>Access Keys: (DISPLAY) Limit Menu Add Limit Add Max Point <i>or</i> Add Min Point</p>
Frequency Sweep	<p>Softkey in the (SWEEP) menu. This key is used to return the analyzer to frequency sweep mode, after it has been used in power sweep mode.</p>
FTP	<p>Softkey in the BOOTP setup menu. Selects FTP as the file transfer protocol used to transfer a boot file from a BOOTP server to the analyzer.</p> <p>See <i>The LAN Interface User's Guide Supplement</i> for more information.</p> <p>Access Keys: (SYSTEM OPTIONS) LAN BOOTP Setup</p>

FTP Password	<p>Softkey in the FTP setup menu. Displays a dialog box for entering the password of your remote BOOTP host.</p> <p>See <i>The LAN Interface User's Guide Supplement</i> for more information.</p> <p>Access Keys: SYSTEM OPTIONS LAN BOOTP Setup FTP</p>
FTP User Name	<p>Softkey in the FTP setup menu. Displays a dialog box for entering the user name of your remote BOOTP host.</p> <p>See <i>The LAN Interface User's Guide Supplement</i> for more information.</p> <p>Access Keys: SYSTEM OPTIONS LAN BOOTP Setup FTP</p>
Full	<p>Softkey in the IBASIC display menu. Displays the IBASIC program on the full screen without measurement data.</p> <p>Access Keys: SYSTEM OPTIONS IBASIC IBASIC Display</p>

G

Gateway IP Address	<p>Softkey in the LAN port setup menu. Allows you to set the gateway IP address that your network administrator assigned to your analyzer. If no address was assigned, leave the setting at 0.0.0.0 (default value) to disable gateway routing.</p> <p>See <i>The LAN Interface User's Guide Supplement</i> for more information.</p> <p>Access Keys: (SYSTEM OPTIONS) LAN LAN Port Setup</p>
GPIB	<p>Softkey in the (SYSTEM OPTIONS) menu. Displays the menu to set the GPIB address of the network analyzer, set and change network analyzer GPIB status, and set the GPIB echo feature.</p>
GPIB Dev. Address	<p>Softkey in the SICL LAN setup menu. Allows you to enter an GPIB device address (bus address) for your analyzer for use with SICL LAN. The default GPIB device address is 18.</p> <p>See <i>The LAN Interface User's Guide Supplement</i> for more information.</p>
GPIB Echo on OFF	<p>Softkey in the GPIB menu. Toggle to ON if you want to display GPIB mnemonics on screen as keys are pressed. This is a convenient way to see the mnemonics associated with the keys.</p> <p>NOTE _____ Not all keys (especially those that display menus) have mnemonics.</p> <p>Access Keys: (SYSTEM OPTIONS) GPIB</p>
GPIB Log. Unit	<p>Softkey in the SICL LAN setup menu. Allows you to enter a logical unit number for use with SICL LAN. The logical unit number is the same as the interface select code (ISC). The default logical unit number is 7.</p> <p>See <i>The LAN Interface User's Guide Supplement</i> for more information.</p>
GPIB Name	<p>Softkey in the SICL LAN setup menu. Allows you to enter the name for a client device that communicates with the analyzer using SICL LAN. The default GPIB name is <code>gpib</code>.</p> <p>See <i>The LAN Interface User's Guide Supplement</i> for more information.</p>

<p>Graph and Mkr Table</p>	<p>Softkey in the define hardcopy menu. Defines the hardcopy to print both the graph and the marker table.</p> <p>NOTE _____ The marker table prints only if one or more markers are on.</p> <p>See “To Define the Output” on page 4-81 for more information.</p> <p>Access Keys: (HARDCOPY) Define Hardcopy</p>
<p>Graph Only</p>	<p>Softkey in the define hardcopy menu. Defines the hardcopy as the graph.</p> <p>See “To Define the Output” on page 4-81 ifor more information.</p> <p>Access Keys: (HARDCOPY) Define Hardcopy</p>
<p>Graphics Pen</p>	<p>Softkey in the set pen numbers menu. Sets pen number assignment (color) for the annotation on a hardcopy.</p> <p>Access Keys: (HARDCOPY) Define Plotter Set Pen Numbers</p>
<p>Graticule ON off</p>	<p>Softkey available in two different menus: the more display menu and the define graph menu. This softkey toggles the display graticule (grid) on and off. When pressed in the more display menu, the graticule are suppressed from showing on the CRT. When pressed in the define graph menu, the graticule are suppressed from printing or plotting on a hardcopy.</p> <p>Access Keys: (DISPLAY) More Display or (HARDCOPY) Define Hardcopy Define Graph</p>

Graticule Pen	<p>Softkey in the set pen numbers menu. Sets pen number assignment (color or width) for the grid on the hardcopy.</p> <p>Access Keys: HARDCOPY Define Plotter Set Pen Numbers</p>
Grey Scale	<p>Softkey in the color options menu for use with an external VGA monitor. Select grey scale when using a monochrome external monitor.</p> <p>Access Keys: DISPLAY More Display Color Options</p>
Group ID	<p>Softkey in the authentication menu. Allows you to enter a Group ID for your NFS remote file system. The default Group ID value is 100.</p> <p>See <i>The LAN Interface User's Guide Supplement</i> for more information.</p> <p>Access Keys: SYSTEM OPTIONS LAN NFS Device Setup Authentication</p>

H

HARDCOPY	<p>Hardkey in the SYSTEM area of the front panel. Displays the menu to start or stop prints or plots, set up the printer or plotter, and determine the appearance of the copy.</p> <p>See “Connecting and Configuring Printers and Plotters” on page 4-70 and “Printing and Plotting Measurement Results” on page 4-80 for more information.</p>
Hardcopy All	<p>Softkey in the operating parameters menu. Dumps all of the operating parameter screens to the currently selected hard copy device.</p> <p>Access Keys: SYSTEM OPTIONS Operating Parameters</p>
Hardcopy Screen	<p>Softkey in the operating parameters menu. Dumps the currently viewed operating parameter screen to the currently selected hard copy device.</p> <p>Access Keys: SYSTEM OPTIONS Operating Parameters</p>
Help Message	<p>Softkey in the update correction constants menu. Displays the help message that describes the actions of the other softkeys in the update correction constants menu.</p> <p>Access Keys: SYSTEM OPTIONS Service Update Corr Const</p>
Hold	<p>Softkey in the trigger menu. Stops the current data trace sweep immediately and holds the sweep until Continuous or Single is selected.</p> <p>Access Keys: MENU Trigger</p>

<p>Horizontal Back Porch</p>	<p>Softkey in the more CRT adjust menu. Adjusts the CRT timing for using the analyzer with an external monitor. Also affects the network analyzer's internal CRT. Default setting is 3.68 μsec. This setting is not affected by an instrument preset.</p> <p>See “Using an External VGA Monitor” on page 4-89 for more information.</p> <p>Access Keys: SYSTEM OPTIONS System Config CRT Adjust More</p>
<p>Horizontal Frnt Porch</p>	<p>Softkey in the more CRT adjust menu. Adjusts the CRT timing for using the analyzer with an external monitor. Also affects the network analyzer's internal CRT. Default setting is 31.68 μsec. This setting is not affected by an instrument preset.</p> <p>See “Using an External VGA Monitor” on page 4-89 for more information.</p> <p>Access Keys: SYSTEM OPTIONS System Config CRT Adjust More</p>
<p>Horizontal Position</p>	<p>Softkey in the CRT adjust menu. Changes the horizontal positioning of the display on both the internal CRT and an external monitor. Accepts whole number values from 1 to 100, with 1 representing as far left as possible and with 100 representing as far right as possible. The default value set at the factory (and obtained by pressing Restore Defaults) is 73. This setting is not affected by an instrument preset.</p> <p>See “Using an External VGA Monitor” on page 4-89 for more information on using an external display.</p> <p>Access Keys: SYSTEM OPTIONS System Config CRT Adjust</p>
<p>Hue</p>	<p>Softkey in the custom colors menu. Use this key to customize the colors of display items on your external monitor. Values accepted for hue are 0 to 99. Zero represents red, and the approximate color progression from there is: orange, yellow, green, cyan, blue, magenta and back to red.</p> <p>See “Using an External VGA Monitor” on page 4-89 for more information.</p> <p>Access Keys: DISPLAY More Display Color Options Custom Colors</p>

Hz	<p>Softkey in the display frequency resolution menu and the numeric entry menu.</p> <p>When pressed in the display frequency resolution menu, displays frequency to Hz resolution.</p> <p>Access Keys: FREQ Disp Freq Resolution</p>
-----------	--

<p>IBASIC</p>	<p>Softkey in the (SYSTEM OPTIONS) menu. IBASIC menu choices include run, continue, step, edit, key record, utilities, and IBASIC display.</p> <p>See the <i>HP Instrument BASIC User's Handbook Supplement</i> and the <i>Automating Measurements User's Guide Supplement</i> for more information.</p>
<p>IBASIC Display</p>	<p>Softkey in the IBASIC menu. Displays a menu to select how to display an IBASIC program.</p> <p>See the <i>HP Instrument BASIC User's Handbook Supplement</i> for more information.</p> <p>Access Keys: (SYSTEM OPTIONS) IBASIC</p>
<p>Imaginary</p>	<p>Softkey in the more format menu. Displays only the imaginary (reactive) portion of the measured data on a Cartesian format. This format is similar to the real format except that reactance data is displayed on the trace instead of impedance data.</p> <p>Access Keys: (FORMAT) More Format</p>
<p>Impedance Magnitude</p>	<p>Softkey in the (FORMAT) menu. Displays impedance magnitude vs. frequency on a Cartesian format.</p> <p>See “Measuring Impedance Magnitude” on page 3-81 for more information.</p> <p>Access Keys: (FORMAT) More Format</p>
<p>Insert Char</p>	<p>Softkey in the IBASIC edit menu. Invokes the insert character menu for editing IBASIC programs.</p> <p>See the <i>HP Instrument BASIC User's Handbook Supplement</i> for more information.</p> <p>Access Keys: (SYSTEM OPTIONS) IBASIC Edit</p>

Insert Line	<p>Softkey in the IBASIC edit menu. Invokes the insert line menu for editing IBASIC programs.</p> <p>See the <i>HP Instrument BASIC User's Handbook Supplement</i> for more information.</p> <p>Access Keys: (SYSTEM OPTIONS) IBASIC Edit</p>
Inst State ON off	<p>Softkey in the define save menu. When on, allows you to save the instrument state.</p> <p>See “Saving and Recalling Measurement Results” on page 4-57 for more information.</p> <p>Access Keys: (SAVE RECALL) Define Save</p>
Install CC From Disk	<p>Softkey in the update correction constants menu. Loads a permanent copy of CC data from a floppy disk to internal EPROM. This must be done after loading new firmware into the analyzer.</p> <p>See the <i>Service Guide</i> for more information.</p> <p>Access Keys: (SYSTEM OPTIONS) Service Update Corr Const</p>
Instrument Info	<p>Softkey in the service menu. Displays the analyzer's firmware revision and date, bootROM version, serial number, options, system impedance, and amount of memory.</p> <p>Access Keys: (SYSTEM OPTIONS) Service</p>
Int Disp Intensity	<p>Softkey in the custom colors menu. This key only affects the analyzer's internal display. This key changes the brightness of the selected display item. Values accepted are 0 to 100%, with 0 resulting in black (not visible) and 100 resulting in full brightness.</p> <p>Access Keys: (DISPLAY) More Display Color Options Custom Colors</p>
Internal	<p>Softkey in the trigger source menu. Selects an automatic, internal trigger.</p> <p>Access Keys: (MENU) Trigger Trigger Source</p>

<p>Internal 3.5" Disk</p>	<p>Softkey in the select disk menu. Selects the analyzer's built-in disk drive as the location where information is saved, re-saved, or recalled.</p> <p>See "Saving and Recalling Measurement Results" on page 4-57 for more information.</p> <p>Access Keys: (SAVE RECALL) Select Disk</p>
<p>Inverse Video</p>	<p>Softkey in the color options menu. Sets the external display to inverse video format.</p> <p>Access Keys: (DISPLAY) More Display Color Options</p>
<p>IP Address to Ping</p>	<p>Softkey in the diagnostic utilities menu. Allows you to set the IP address of the computer or device that you are trying to verify connectivity to.</p> <p>See <i>The LAN Interface User's Guide Supplement</i> for more information.</p> <p>Access Keys: (SYSTEM OPTIONS) LAN LAN Port Setup Diagnostic Utilities</p>
<p>Isolation on OFF</p>	<p>Softkey in the two-port cal menu. Toggle to ON if you want to remove systematic errors caused by crosstalk. Crosstalk can be a problem with high-isolation devices and high-dynamic range devices. Since this isolation calibration adds noise to the error model, you should only select it if it is really needed.</p> <p>Refer to Chapter 6 for more information.</p> <p>Access Keys: (CAL) User 2-Port</p>

K

<p>Key Record on OFF</p>	<p>Softkey in the IBASIC menu. Toggle to ON if you want to translate front panel keystrokes into program lines to automatically set up and run the analyzer.</p> <p>Press (SYSTEM OPTIONS) IBASIC Key Record ON (PRESET) to begin the program. Press (SYSTEM OPTIONS) IBASIC Key Record OFF to end the program. Only one program can be stored in memory at a time, but programs can also be stored to internal and external disks.</p> <hr/> <p>NOTE When editing an IBASIC program, Key Record on OFF should be off.</p> <hr/> <p>See the <i>HP Instrument BASIC User's Handbook Supplement</i> for more information.</p> <p>Access Keys: (SYSTEM OPTIONS) IBASIC</p>
<p>kHz</p>	<p>Softkey in the display frequency resolution menu and the numeric entry menu.</p> <p>When pressed in the display frequency resolution menu, displays the frequency selected in kHz resolution. For example, 1.234 567 MHz (Hz resolution) is displayed as 1.235 MHz (note rounding up) in kHz resolution.</p> <p>Access Keys: (FREQ) Disp Freq Resolution</p>

L

LAN	Softkey in the (SYSTEM OPTIONS) menu. Displays the menu to setup your LAN port and to turn the LAN state on or off. Refer to <i>The LAN Interface User's Guide Supplement</i> for information.
LAN Port Setup	Softkey in the LAN menu. Displays the menu to set up the LAN port on your analyzer. Refer to <i>The LAN Interface User's Guide Supplement</i> for information. Access Keys: (SYSTEM OPTIONS) LAN
LAN Print IP Addr	Softkey in the select copy port menu. Sets the recognized IP address of a LAN printer. Refer to <i>The LAN Interface User's Guide Supplement</i> for information. Access Keys: (HARDCOPY) Select Copy Port
LAN State ON off	Softkey in the LAN menu. Allows you to enable or disable the LAN feature. ON is the default setting, but when toggled OFF, more memory is available to IBASIC and the volatile RAM disk. Refer to <i>The LAN Interface User's Guide Supplement</i> for information. Access Keys: (SYSTEM OPTIONS) LAN
Landscape	Softkey in the define printer menu. Sets the printer to print hardcopy so that the paper is oriented with the longer edge at the top and the shorter edges at the sides. Toggles with Portrait . Access Keys: (HARDCOPY) Define Printer
Left Margin	Softkey in the more printer menu. Sets the left margin (non-printing space) in mm (25.4 mm = 1.00 inches). Minimum setting is 0.00 mm (default); maximum is 200 mm. Access Keys: (HARDCOPY) Define Printer More Printer

Level	<p>Softkey in the POWER menu. Sets the RF power level of the analyzer's source.</p> <p>See Chapter 9, "Specifications," for the minimum and maximum power levels for your analyzer.</p>
Limit	<p>Softkey in the max point or min point menus. Sets the amplitude of a limit point.</p> <p>See "To Create a Single Point Limit" on page 4-32 for an example of how to set a limit point.</p> <p>Access Keys: DISPLAY Limit Menu Add Limit , Add Max Point or Add Min Point</p>
Limit Icon ON off	<p>Softkey in the limit options menu. Disables the  fail indicator from being displayed on the analyzer's screen. Does <i>not</i> disable PASS or FAIL text. Pass/fail text can be disabled with the Limit Text ON off softkey.</p> <p>See "Customizing the Display" on page 4-45 for more information.</p> <p>Access Keys: DISPLAY Limit Menu Limit Options</p>
Limit Icon X Position	<p>Softkey in the limit options menu. Allows for customizing the position of the pass/fail indicator and text on the analyzer's display.</p> <p>See "Customizing the Display" on page 4-45 for more information.</p> <p>Access Keys: DISPLAY Limit Menu Limit Options</p>
Limit Icon Y Position	<p>Softkey in the limit options menu. Allows for customizing the position of the pass/fail indicator and text on the analyzer's display.</p> <p>See "Customizing the Display" on page 4-45 for more information.</p> <p>Access Keys: DISPLAY Limit Menu Limit Options</p>
Limit Menu	<p>Softkey in the DISPLAY menu. Displays the limit-testing menu to select, display, add, delete, and edit limit lines and other limit tests.</p> <p>See "Using Limit Testing" on page 4-28 for more information.</p>

Limit Line on OFF	<p>Softkey in the limit options menu. Toggle to ON if you want limit lines or points in the limit table to be visible on the CRT. Does <i>not</i> turn off limit testing — only turns off visible limit lines or points.</p> <p>See “Using Limit Testing” on page 4-28 for more information.</p> <p>Access Keys: DISPLAY Limit Menu Limit Options</p>
Limit Options	<p>Softkey in the limit options menu. Displays a menu that allows you to turn visible limit lines on or off, and to reposition and enable/disable the pass/fail indicator and text.</p> <p>See “Customizing the Display” on page 4-45 for more information.</p> <p>Access Keys: DISPLAY Limit Menu</p>
Limit Test on OFF	<p>Softkey in the limit menu. Toggle to ON if you want to view the limit test status. When limit test is enabled, "FAIL" or "PASS" notation may be displayed on the CRT. Pass/fail information is also routed to the LIMIT TEST TTL IN/OUT connector on the rear panel of the analyzer. The limits need not be visible (toggled to ON) for the limit test to be valid.</p> <p>See “Using Limit Testing” on page 4-28 for more information.</p> <p>Access Keys: DISPLAY Limit Menu</p>
Limit Text ON off	<p>Softkey in the limit options menu. Allows you to enable or disable the PASS or FAIL text when limit testing is on. Does <i>not</i> enable or disable the  fail icon. The fail icon is enabled/disabled with the Limit Icon ON off softkey.</p> <p>See “Customizing the Display” on page 4-45 for more information.</p> <p>Access Keys: DISPLAY Limit Menu Limit Options</p>
Lin Mag	<p>Softkey in the FORMAT menu. Displays a transmission trace in terms of transmission coefficient, displays a reflection trace in terms of reflection coefficient, and displays an aux input trace in volts (from 1 mV/div to 20 V/div).</p>

<p>List Trace Values</p>	<p>Softkey in the define hardcopy menu. Defines the hardcopy as a list of data trace values. Trace values for Cartesian format are in two columns: frequency and amplitude. Trace values for polar format are in three columns: frequency, magnitude, and phase. Trace values for Smith chart format are also in three columns: frequency, resistance and complex impedance.</p> <hr/> <p>NOTE Plotting lists with many data points can be very time consuming.</p> <hr/> <p>See “Printing and Plotting Measurement Results” on page 4-80 for more information.</p> <p>Access Keys: (HARDCOPY) Define Hardcopy</p>
<p>Load</p>	<p>Softkey in the modify kit menu. Allows you to modify the following characteristics of the load calibration standard in your calibration kit: delay, loss, and Z_0.</p> <p>See “Calibration Kits” on page 6-23 for more information.</p> <p>Access Keys: (CAL) More Cal Cal Kit Modify (connector type)</p>
<p>Load CC From Disk</p>	<p>Softkey in the update correction constants menu. Loads a temporary copy of CC data from floppy disk to the analyzer's internal volatile RAM.</p> <p>See the <i>Service Guide</i> for more information.</p> <p>Access Keys: (SYSTEM OPTIONS) Service Update Corr Const</p>

<p>Local Path</p>	<p>Softkey in the automount setup menu and the mount NFS device menu. Displays a dialog box for entering the local file system path for an NFS device.</p> <p>Access Keys: SYSTEM OPTIONS LAN NFS Device Setup Automount Setup or Mount NFS Device</p> <p>This softkey also appears in the automount dev table menu and the NFS device table menu. Displays an <i>expanded</i> version of the local file system information found in the automount device table and the NFS device table.</p> <p>Access Keys: SYSTEM OPTIONS LAN NFS Device Setup NFS Device Table or SYSTEM OPTIONS LAN NFS Device Setup Automount Setup Automount Device Table</p> <p>See <i>The LAN Interface User's Guide Supplement</i> for more information.</p>
<p>Login User Setup</p>	<p>Softkey in the LAN menu. Displays the users setup menu which allows you to enter or delete a login user/password pair on the access list of your analyzer.</p> <p>See <i>The LAN Interface User's Guide Supplement</i> for more information.</p> <p>Access Keys: SYSTEM OPTIONS LAN</p>
<p>Log Mag</p>	<p>Softkey in the FORMAT menu. Displays the logarithmic magnitude of the data in dB. This is the default format.</p>
<p>Loss</p>	<p>Softkey in the open, short, load, and through menus. Allows you to modify the loss characteristic of the open, short, load, or through calibration standards in your calibration kit.</p> <p>See "Calibration Kits" on page 6-23 for more information.</p> <p>Access Keys: CAL More Cal Cal Kit Modify (connector type) , Open or Short or Load or Thru</p>

<p>Lotus 123 Format</p>	<p>Softkey in the save ASCII menu. Saves measurement data in a format compatible with popular spreadsheet programs such as Lotus 1-2-3.</p> <p>See “Saving Instrument Data” on page 4-59 for more information.</p> <p>Access Keys: SAVE RECALL Define Save Save ASCII</p>
<p>Lower</p>	<p>Softkey in the IBASIC display menu. Displays the IBASIC program on the lower half of the screen and measurement data on the upper half.</p> <p>See the <i>HP Instrument BASIC User's Handbook Supplement</i> for more information.</p> <p>Access Keys: SYSTEM OPTIONS IBASIC IBASIC Display</p>
<p>Luminance</p>	<p>Softkey in the custom colors menu. Use this key to customize the colors of display items on your external monitor. Luminance specifies the brightness of the selected color. (Use the Hue key to select the color.) Luminance values are expressed as a percentage: 0 to 100%, with 0 resulting in black, and 100 resulting in the brightest color available.</p> <p>See “Using an External VGA Monitor” on page 4-89 for more information.</p> <p>Access Keys: DISPLAY More Display Color Options Custom Colors</p>

M

Mag Units	Softkey in the more format menu. Displays choices for various magnitude units for the y-axis scale. Access Keys: FORMAT More Format
Make Directory	Softkey in the directory utilities menu. Displays the character entry menu for entry of the directory name. See “To Use Directory Utilities” on page 4-67 for more information. Access Keys: SAVE RECALL File Utilities Directory Utilities
Manual Zero	Softkey in the CAL menu. This softkey is only available when using internal or external broadband detectors. Compensates for detector drift one time when selected. When your external RF source is at the detectors, this is the recommended setting to coordinate RF off and zeroing.
Marker	Softkey in the add max line, add min line, add max point, and add min point menus. Adds a marker to the data trace and allows it to be moved to identify trace frequencies and amplitudes. Access Keys: DISPLAY Limit Menu Add Limit , Add Max Line <i>or</i> Add Min Line <i>or</i> Add Max Point <i>or</i> Add Min Point
MARKER	Hardkey in the CONFIGURE area. Displays the menu to set markers, use marker search and delta markers. See “Using Markers” on page 4-3 for more information.
Marker -> Center	Softkey in the marker functions menu. Changes the center frequency to that of the active marker and modifies the frequency span accordingly. If markers are off, it first turns on marker #1 at its previous setting or at the center frequency (default). Access Keys: MARKER Marker Functions

Marker -> Elec Delay -	<p>Softkey in the marker functions menu. Adjusts the electrical delay to balance the phase of the DUT. This is performed automatically, regardless of the format and the measurement being made. Enough line length is added to or subtracted from the receiver input to compensate for the phase slope at the active marker position. This effectively flattens the phase trace around the active marker, and can be used to measure electrical length or deviation from linear phase. Additional electrical delay adjustments are required on DUTs without constant group delay over the measured frequency span. Since this feature adds phase to a variation in phase versus frequency, it is applicable only for ratioed inputs.</p> <p>Access Keys: (MARKER) Marker Functions</p>
Marker -> Reference -	<p>Softkey in the marker functions menu. Makes the reference level of the graticule equal to the marker value; does not change the reference <i>position</i>. If markers are off, it first turns on marker #1 at its previous setting or the center frequency (default).</p> <p>Access Keys: (MARKER) Marker Functions</p>
Marker Functions	<p>Softkey in the (MARKER) menu. Invokes the menu to select delta marker mode, marker to center, marker to reference, marker to electrical delay, and marker math functions.</p>
Marker Math	<p>Softkey in the marker functions menu. Brings up the menu to select statistics, flatness, and RF filter statistics calculations on user-defined trace segments.</p> <p>See Flatness , RF Filter Stats , and Statistics in this chapter.</p> <p>Access Keys: (MARKER) Marker Functions</p>
Marker Search	<p>Softkey in the (MARKER) menu. Displays the marker search menu to perform various marker search functions.</p> <p>See “Using Markers” on page 4-3 for more information.</p>

Max Limit	<p>Softkey in the edit limit (min/max) menu. Use this key to set the maximum limit for the marker limit function that is currently highlighted in the on-screen table.</p> <p>See “To Use Marker Limit Functions” on page 4-32 for more information.</p> <p>Access Keys: DISPLAY Limit Menu Mkr Limits Edit Limit (Min/Max)</p>
Max Search	<p>Softkey in the marker search menu. Places the active marker at the frequency point of maximum amplitude. If tracking is off, the marker remains at that frequency. If tracking is on, the marker moves to the maximum point with each sweep.</p> <p>See “Using Markers” on page 4-3 for more information.</p> <p>Access Keys: MARKER Marker Search</p>
MEAS 1	<p>Hardkey in the MEAS area. Turns on measurement channel 1 as the active channel. Default mode is the S_{11} measurement.</p>
MEAS 2	<p>Hardkey in the MEAS area. Turns on measurement channel 2 as the active channel. Default is measurement channel off; selecting it changes setting to the most recent type of measurement made on this channel, or, if not previously used, to the S_{11} measurement.</p>
Meas Annot ON off	<p>Softkey in the annotation options menu. Allows you to toggle the measurement channel annotation at the top of the display on or off.</p> <p>See “Customizing the Display” on page 4-45 for more information.</p> <p>Access Keys: DISPLAY More Display Annotation Options</p>
Meas OFF	<p>Softkey in the MEAS 1 or MEAS 2 menu. Turns the active measurement channel off.</p>
Measure Standard	<p>Softkey in several calibration menus. Measures a calibration standard as part of your selected calibration procedure.</p>

Med Narrow 1200 Hz	<p>Softkey in the system bandwidth menu. The default system bandwidth is medium wide.</p> <p>See Chapter 5 for information on how system bandwidth can affect your measurements.</p> <p>Access Keys: (AVG) System Bandwidth</p>
Med Wide 4000 Hz	<p>Softkey in the system bandwidth menu. Medium wide is the default system bandwidth.</p> <p>See Chapter 5 for information on how system bandwidth can affect your measurements.</p> <p>Access Keys: (AVG) System Bandwidth</p>
Medium 3700 Hz	<p>Softkey in the system bandwidth menu. The default system bandwidth is medium wide.</p> <p>See Chapter 5 for information on how system bandwidth can affect your measurements.</p> <p>Access Keys: (AVG) System Bandwidth</p>
Memory	<p>Softkey in the (DISPLAY) menu. Displays the trace memory of the active measurement channel, using the current display format, scale, and reference.</p> <p>NOTE _____ Trace data must have been saved in memory previously with Data->Mem.</p>
Memory 1 Pen	<p>Softkey in the set pen numbers menu. Sets the pen number assignment (color) for memory trace 1 on the hardcopy.</p> <p>Access Keys: (HARDCOPY) Define Plotter Set Pen Numbers</p>
Memory 2 Pen	<p>Softkey in the set pen numbers menu. Sets the pen number assignment (color) for memory trace 2 on the hardcopy.</p> <p>Access Keys: (HARDCOPY) Define Plotter Set Pen Numbers</p>
(MENU)	<p>Hardkey in the SOURCE area. Displays the menu with source setting selections: trigger functions, number of points, external reference, and spur avoid features.</p>

MHz	<p>Softkey in the display frequency resolution menu and the numeric entry menu.</p> <p>When pressed in the display frequency resolution menu, displays the frequency to MHz resolution. For example, 1.234 567 MHz is displayed as 1 MHz (note rounding down).</p> <p>Access Keys: FREQ Disp Freq Resolution</p>
Min Limit	<p>Softkey in the edit limit (min/max) menu. Use this key to set the minimum limit for the marker limit function that is currently highlighted in the on-screen table.</p> <p>See “To Use Marker Limit Functions” on page 4-32 for more information.</p> <p>Access Keys: DISPLAY Limit Menu Mkr Limits Edit Limit (Min/Max)</p>
Min Search	<p>Softkey in the marker search menu. Places the active marker at the frequency point of minimum amplitude. If tracking is off, the marker remains at that frequency. If tracking is on, the marker moves to the minimum point with each sweep.</p> <p>See “Using Markers” on page 4-3 for more information.</p> <p>Access Keys: MARKER Marker Search</p>
Mixer	<p>Softkey in the BEGIN menu. Displays the menu with selections suitable for mixer and frequency converter measurements: conversion loss and S_{11}.</p> <p>See “Measuring Conversion Loss” on page 3-62 for an example conversion loss measurement.</p>
Mkr Annot ON off	<p>Softkey in the annotation options menu. Toggle to ON if you want to view the marker information in the upper right corner of the display.</p> <p>See “Customizing the Display” on page 4-45 for more information.</p> <p>Access Keys: DISPLAY More Display Annotation Options</p>

<p>Mkr Limit on OFF</p>	<p>Softkey in the mkr limits menu. Toggle to ON if you want to enable marker limit testing.</p> <p>See “To Use Marker Limit Functions” on page 4-32 for more information.</p> <p>Access Keys: DISPLAY Limit Menu Mkr Limits</p>
<p>Mkr Limits</p>	<p>Softkey in the limit menu. Displays the marker limits menu where limit testing can be placed on statistics, flatness marker searches, and delta amplitude or frequency.</p> <p>See “To Use Marker Limit Functions” on page 4-32 for more information.</p> <p>Access Keys: DISPLAY Limit Menu</p>
<p>Mkr Number ON off</p>	<p>Softkey in the annotation options menu. Allows you to toggle the marker numbers (but not the triangular indicators) on or off.</p> <p>See “Customizing the Display” on page 4-45 for more information.</p> <p>Access Keys: DISPLAY More Display Annotation Options</p>
<p>Mkr Symbol ON off</p>	<p>Softkey in the define graph menu. When on (default setting), prints or plots contain marker symbols.</p> <p>NOTE Graph and Mkr Table or Graph Only must be selected for marker symbols to print or plot.</p> <p>Access Keys: HARDCOPY Define Hardcopy Define Graph</p>
<p>Mkr Table Only</p>	<p>Softkey in the define hardcopy menu. Defines the hardcopy output as a table of marker values (frequency and amplitude).</p> <p>Access Keys: HARDCOPY Define Hardcopy</p>
<p>Mkr -> Max</p>	<p>Softkey in the max search menu. Places the active marker at the frequency point of maximum amplitude. If tracking is off, the marker remains at that frequency. If tracking is on, the marker moves to the maximum point with each sweep.</p> <p>See “Using Markers” on page 4-3 for more information.</p> <p>Access Keys: MARKER Marker Search Max Search</p>

Mkr -> Min	<p>Softkey in the min search menu. Places the active marker at the frequency point of minimum amplitude. If tracking is off, marker remains at that frequency. If tracking is on, marker moves to the minimum point with each sweep.</p> <p>See “Using Markers” on page 4-3 for more information.</p> <p>Access Keys: (MARKER) Marker Search Min Search</p>
MM-DD-YYYY HH:MM	<p>Softkey in the clock format menu. Formats the real-time internal clock to display time as Month-Day-Year Hour:Minute.</p> <p>Access Keys: (SYSTEM OPTIONS) System Config Set Clock Clock Format</p>
Modify (connector type)	<p>Softkey in the cal kit menu. Allows you to modify the characteristics of the calibration standards in the calibration kit you have selected. Also allows you to save this modified kit as either Cal Kit A or Cal Kit B.</p> <p>See “Calibration Kits” on page 6-23 for more information. Access Keys: (CAL) More Cal Cal Kit</p>
Modify Size	<p>Softkey in the configure VOL_RAM disk menu. Allows you to modify the memory allocation on the internal non-volatile RAM disk.</p> <p>Access Keys: (SAVE RECALL) Select Disk Configure VOL_RAM</p>
Mod Kit SaveRecall	<p>Softkey in the modify kit menu. Accesses a menu with softkey choices to save, recall, preset, and describe user-defined calibration kits.</p> <p>See “Calibration Kits” on page 6-23 for more information.</p> <p>Access Keys: (CAL) More Cal Cal Kit Modify (Cal Kit type)</p>
Monochrome	<p>Softkey in the define printer and define plotter menus. Toggles with Color to define printer or plotter as one color (black and white) or multi-color.</p> <p>See “Connecting and Configuring Printers and Plotters” on page 4-70 for more information.</p> <p>Access Keys: (HARDCOPY) Define Printer , or Define Plotter</p>

<p>Monochrome Pen</p>	<p>Softkey in the set pen numbers menu. Sets the pen number assignment for the hardcopy in monochrome plot mode.</p> <p>See “Connecting and Configuring Printers and Plotters” on page 4-70 for more information.</p> <p>Access Keys: HARDCOPY Broadband Internal Define Plotter Set Pen Numbers</p>
<p>Mount NFS Device</p>	<p>Softkey in the NFS setup menu. Allows you to mount an NFS device by entering the remote host name (or host IP address), the remote file system path, and a local system path. See <i>The LAN Interface User's Guide Supplement</i> for more information.</p> <p>Access Keys: SYSTEM OPTIONS LAN NFS Device Setup</p>
<p>MultiNotch</p>	<p>Softkey in the marker search more menu. Designed for use when measuring multi-pole filters. Automatically searches the measurement trace from left to right and positions up to 8 markers on consecutive minimum points.</p> <p>See “To Use Marker Search Functions” on page 4-7 for more information.</p> <p>Access Keys: MARKER Marker Search More</p>
<p>Multi Peak</p>	<p>Softkey in the marker search more menu. Designed for use when measuring multi-pole filters. Automatically searches the measurement trace from left to right and positions up to 8 markers on consecutive maximum points.</p> <p>See “To Use Marker Search Functions” on page 4-7 for more information.</p> <p>Access Keys: MARKER Marker Search More</p>
<p>Multiport on OFF</p>	<p>Softkey in the switching test set menu. Toggle to ON if you want to configure the analyzer for use with a multiport test set.</p> <p>Refer to the multiport test set <i>User's and Service Guide</i> for more information.</p> <p>Access Keys: SYSTEM OPTIONS System Config Switching Test Set</p>

N

Narrow 250 Hz	<p>Softkey in the system bandwidth menu. The default system bandwidth is medium wide.</p> <p>See Chapter 5 for information on how system bandwidth can affect your measurements.</p> <p>Access Keys: (AVG) System Bandwidth</p>
Narrowband Internal	<p>Softkey in the detection options menu. Selects tuned receiver type measurements of inputs A, B, or R or the ratios A/R or B/R.</p> <p>See “Measuring Devices with Your Network Analyzer” on page 3-3 for more information.</p> <p>Access Keys: (MEAS 1) or (MEAS 2), More Detection Options</p>
Network Stat Capture	<p>Softkey in the diagnostic utilities menu. Captures, records, and displays network statistics (TCP, IP, UDP, and local routing table) at the moment that it is enabled, like a snapshot.</p> <p>See <i>The LAN Interface User’s Guide Supplement</i> for more information.</p> <p>Access Keys: (SYSTEM OPTIONS) LAN LAN Port Setup Diagnostic Utilities</p>
Next Min Left	<p>Softkey in the min search menu. Moves the active marker to the next nearest minimum point to the left.</p> <p>See “To Use Marker Search Functions” on page 4-7 for more information.</p> <p>Access Keys: (MARKER) Marker Search Min Search</p>
Next Min Right	<p>Softkey in the min search menu. Moves the active marker to the next nearest minimum point to the right.</p> <p>See “To Use Marker Search Functions” on page 4-7 for more information.</p> <p>Access Keys: (MARKER) Marker Search Min Search</p>

NFS Device	<p>Softkey in the select disk menu. Displays NFS devices which are currently mounted. Select the device you want to use for save/recall from the table and press the softkey that corresponds to the device.</p> <p>See <i>The LAN Interface User's Guide Supplement</i> for more information.</p> <p>Access Keys: SAVE RECALL Select Disk</p>
NFS Device Setup	<p>Softkey in the LAN menu. Displays the NFS setup menu which allows you to enter setup information for mounting NFS devices.</p> <p>See <i>The LAN Interface User's Guide Supplement</i> for more information.</p> <p>Access Keys: SYSTEM OPTIONS LAN</p>
NFS Device Table	<p>Softkey in the NFS setup menu. Displays a table listing the currently mounted NFS devices.</p> <p>See <i>The LAN Interface User's Guide Supplement</i> for more information.</p> <p>Access Keys: SYSTEM OPTIONS LAN NFS Device Setup</p>
Next Peak Left	<p>Softkey in the max search menu. Moves the active marker to the next nearest peak to the left.</p> <p>See "To Use Marker Search Functions" on page 4-7 for more information.</p> <p>Access Keys: MARKER Marker Search Max Search</p>
Next Peak Right	<p>Softkey in the max search menu. Moves the active marker to the next nearest peak to the right.</p> <p>See "To Use Marker Search Functions" on page 4-7 for more information.</p> <p>Access Keys: MARKER Marker Search Max Search</p>
Non-Vol RAM Disk	<p>Softkey in the select disk menu. Selects the analyzer's internal non-volatile RAM as the location where information is saved, re-saved, or recalled.</p> <p>See "Saving and Recalling Measurement Results" on page 4-57 for more information.</p> <p>Access Keys: SAVE RECALL Select Disk</p>

None	Softkey in the IBASIC display menu. Displays the measurement data on the full screen. (Does not show the IBASIC program on the display at all.)
Normalize	<p>Softkey in the DISPLAY menu. Equivalent to selecting Data->Mem and Data/Mem. Corrects for frequency response errors only. The only type of measurement "calibration" (other than detector zero) for power or conversion loss measurements.</p> <p>NOTE This type of "calibration" is not interpolated: changes in frequency or the number of points invalidate it.</p> <p>See "To Perform a Normalization Calibration" on page 6-14 for more information.</p>
Normalize on OFF	Softkey in the CAL menu. Toggle to ON if you want to select the normalize "calibration" described above.
Notch	<p>Softkey in the marker search menu. Automatically calculates -6 dB (default) or other user-specified bandwidth, center frequency, and Q of a notch filter.</p> <p>See "Using Markers" on page 4-3 for more information.</p> <p>Access Keys: MARKER Marker Search</p>
Number of Points	<p>Softkey in the source MENU. Allows selection of the number of measurement points in a sweep: 3, 5, 11, 21, 51, 101, 201 (default), 401, 801, or 1601. As the number of points increases, frequency resolution increases and sweep speed decreases.</p> <p>See "To Reduce the Number of Measurement Points" on page 5-5 for information on how the number of measurement points selected can affect your measurements.</p>
Numeric	<p>Softkey in the clock format menu. Formats the real-time internal clock to display the number of the month (for example, 03 for March).</p> <p>Access Keys: SYSTEM OPTIONS System Config Set Clock Clock Format</p>

O

Open	<p>Softkey in the modify kit menu. Allows you to modify the following characteristics of the open calibration standard in your calibration kit: C₀, C₁, C₂, C₃, delay, loss, and Z₀.</p> <p>See “Calibration Kits” on page 6-23 for more information.</p> <p>Access Keys: CAL More Cal Cal Kit Modify (connector type)</p>
Operating Parameters	<p>Softkey in the SYSTEM OPTIONS menu. Displays several screens of measurement channel settings, cal kit definitions, instrument settings, and instrument configuration.</p>
Optional Boot Host	<p>Softkey in the BOOTP setup menu. Allows you to set the host name or host IP address of the only remote host you want to receive BOOTP requests. If the optional boot host is not designated, the analyzer will broadcast a BOOTP request at boot time and will accept a response from <i>any</i> BOOTP server. If you don't want to designate an optional boot host, enter a null or empty string by selecting Clear Entry Enter .</p> <p>See <i>The LAN Interface User's Guide Supplement</i> for more information.</p> <p>Access Keys: SYSTEM OPTIONS LAN BOOTP Setup</p>
Optional File Path	<p>Softkey in the BOOTP setup menu. Allows you to set the file path to the only boot file you want to receive at boot time. If you don't want to designate an optional file path, enter a null or empty string by selecting Clear Entry Enter .</p> <p>See <i>The LAN Interface User's Guide Supplement</i> for more information.</p> <p>Access Keys: SYSTEM OPTIONS LAN BOOTP Setup</p>

P

Parameters Received	Softkey in the BOOTP setup menu. Displays the BOOTP parameters received from the BOOTP host: host address, IP address, gateway IP address, subnet mask, and file path. See <i>The LAN Interface User's Guide Supplement</i> for more information.
Password	Softkey in the add login user menu and delete login user menu. Displays a dialog box for entering a password to be added or deleted on the access list of your analyzer. See <i>The LAN Interface User's Guide Supplement</i> for more information. Access Keys: (SYSTEM OPTIONS) LAN Login User Setup , Add Login User or Delete Login User
Path FWD rev	Softkey in the measurement menus. Allows you to toggle the direction of the source signal path.
Perform Ping	Softkey in the diagnostic utilities menu. Allows you access the ping utility to determine the status of the connections between devices and a network. See <i>The LAN Interface User's Guide Supplement</i> for more information. Access Keys: (SYSTEM OPTIONS) LAN LAN Port Setup Diagnostic Utilities
Perform Secure	Softkey in the secure menu. Use with caution: secured program lines can't be listed, seen, or edited. See the <i>HP Instrument BASIC User's Handbook Supplement</i> for more information. Access Keys: (SYSTEM OPTIONS) IBASIC Utilities Secure
Phase	Softkey in the (FORMAT) menu. Displays a Cartesian format of the phase portion of the data, measured in degrees. This format displays the phase shift versus frequency.

Phase Offset	Softkey in the SCALE menu. Adds or subtracts a phase offset that is constant with frequency (rather than linear).
Polar	Softkey in the more format menu. Displays a polar format. Each point on the polar format corresponds to a particular value of both magnitude and phase. Quantities are read vectorally: the magnitude at any point is determined by its displacement from the center (which has zero value), and the phase by the angle counterclockwise from the positive x-axis. Magnitude is scaled in a linear fashion, with the value of the outer circle usually set to a ratio value of 1. Since there is no frequency axis, frequency information is read from the markers.
Port 1 Extension	Softkey in the port extensions menu. Allows compensation for phase shift due to an extended measurement reference plane on port 1. See “Port Extensions” on page 5-18 for more information. Access Keys: CAL More Cal Port Extensions Port Ext's on OFF
Port 2 Extension	Softkey in the port extensions menu. Allows compensation for phase shift due to an extended measurement reference plane on port 2. See “Port Extensions” on page 5-18 for more information. Access Keys: CAL More Cal Port Extensions Port Ext's on OFF
Port Ext's on OFF	Softkey in the port extensions menu. Toggle to ON if you want to compensate for phase shift due to an extended measurement reference plane. See “Port Extensions” on page 5-18 for more information. Access Keys: CAL More Cal Port Extensions
Portrait	Softkey in the define printer menu. Sets printer to print hardcopy so that paper is oriented with shorter edge at top and longer edges at sides. Portrait is the default setting, and toggles with Landscape. Access Keys: HARDCOPY Define Printer

<p>Power</p>	<p>Softkey in the amplifier and measurement menus, suitable for power measurements.</p> <p>See “Making a Power Measurement using Broadband Detection” on page 3-57 for an example power measurement.</p> <p>Access Keys: (BEGIN) Amplifier or (MEAS 1) or (MEAS 2) More</p>
<p>(POWER)</p>	<p>Hardkey in the SOURCE area. Sets the power level of the internal RF source and turns it on and off. Also allows the setting of parameters for a power sweep and the setting of the power level at preset.</p>
<p>Power Sweep</p>	<p>Softkey in the (SWEEP) menu. This softkey turns on a power sweep mode that is used to characterize power-sensitive circuits. In this mode, power is swept at a single frequency. The start- and stop-power values are selectable under the (POWER) key. This feature is convenient for such measurements as gain compression or automatic gain control (AGC) slope.</p> <p>Power sweep is independent of level. Use this function with frequency CW mode only.</p> <p>The span of the swept power is limited to being equal to or within one of the seven pre-defined power ranges.</p>
<p>(PRESET)</p>	<p>Hardkey in the SYSTEM area. Displays softkeys that allow you to choose between a factory preset state or a user-defined preset state. See Chapter 11, “Factory Preset State and Memory Allocation,” for a complete list of factory preset state default parameters. See User Preset on page 8-96 for an explanation of a user-defined preset state.</p> <p>(PRESET) can also be used in the event that your analyzer system locks up, or you receive an "Unrecoverable error." If this should happen, cycle the power on the analyzer, and press the (PRESET) key several times while the analyzer is booting up. (The (PRESET) key must be pressed at least twice after you hear the double beep.) Then, follow the on-screen instructions. This procedure clears all information in non-volatile memory, including calibrations.</p>

<p>Preset All User Kits</p>	<p>Softkey in the mod kit save/recall menu. Presets all of the User Cal Kits to the type-N(f) calibration kit. This reduces the size of your saved instrument state since user-defined calibration kits (Cal Kits A–J) aren't included in the saved information.</p> <p>See “Calibration Kits” on page 6-23 for more information.</p> <p>Access Keys: CAL More Cal Cal Kit Modify (connector type) Mod Kit SaveRecall</p>
<p>Preset User Kit</p>	<p>Softkey in the mod kit save/recall menu. Presets the selected User Cal Kit to the type-N(f) calibration kit. This reduces the size of your saved instrument state since the user-defined calibration kit isn't included in the saved information.</p> <p>See “Calibration Kits” on page 6-23 for more information.</p> <p>Access Keys: CAL More Cal Cal Kit Modify (connector type) Mod Kit SaveRecall</p>
<p>Print Width</p>	<p>Softkey in the more printer menu. Sets print width (printing space) in mm.</p> <p>See “Connecting and Configuring Printers and Plotters” on page 4-70 for more information.</p> <p>Access Keys: HARDCOPY Define Printer More Printer</p>
<p>Print/Plot GPIB Addr</p>	<p>Softkey in the select copy port menu. Sets the recognized address of GPIB printers and plotters only. The default address is 5. The "recognized GPIB address" is the address that the network analyzer uses to communicate with the device. The actual address of the device must be set independently to match.</p> <p>See “Connecting and Configuring Printers and Plotters” on page 4-70 for more information.</p> <p>Access Keys: HARDCOPY Select Copy Port</p>

<p>Printer Resolution</p>	<p>Softkey in the more printer menu. Sets printer resolution in terms of dots per inch. Check the printer manual for the appropriate setting. Default is 96 dots per inch.</p> <p>See “Connecting and Configuring Printers and Plotters” on page 4-70 for more information on printer resolution.</p> <p>Access Keys: HARDCOPY Define Printer More Printer</p>
<p>Programs</p>	<p>Softkey in the SAVE RECALL menu. Displays the menu to save, re-save, recall programs, or save a program as an autostart (AUTOST) program.</p> <p>See the <i>HP Instrument BASIC User's Handbook Supplement</i> for more information.</p>
<p>Pwr Level at Preset</p>	<p>Softkey in the POWER menu. Allows you to set a power level (other than the factory default of 0 dBm) that the analyzer will always return to when the Factory Preset key is pressed. Be sure to terminate your entry with one of the softkeys or the ENTER key.</p>
<p>Pwr Sweep Range</p>	<p>Softkey in the POWER menu. Leads to the power sweep ranges menu. There are seven predetermined power ranges to choose from.</p> <p>See the Power Sweep entry in this chapter for more information on the power sweep function.</p>

R

R	<p>Softkey in the narrowband internal menu. Selects the tuned receiver measurement of input R (reference signal).</p> <p>See “Measuring Devices with Your Network Analyzer” on page 3-3 for information on receiver inputs.</p> <p>Access Keys: MEAS 1 or MEAS 2, More Detection Options Narrowband Internal</p>
R*	<p>Softkey in the broadband internal menu. Selects the diode detection type measurement of input R* (broadband internal reference signal).</p> <p>See “Measuring Devices with Your Network Analyzer” on page 3-3 for information on receiver inputs.</p> <p>Access Keys: MEAS 1 or MEAS 2, More Detection Options Broadband Internal</p>
Re-Save Program	<p>Softkey in the programs menu. Displays the character entry menu to re-title the program and save it to memory or disk.</p> <p>See the <i>HP Instrument BASIC User's Handbook Supplement</i> for more information.</p> <p>Access Keys: SAVE RECALL Programs</p>
Re-Save State	<p>Softkey in the SAVE RECALL menu. Displays the character entry menu to re-title the file and save it to internal RAM or 3.5" disk. Also can be used when saving a file for the first time if you wish to give the file a specific name, rather than having the analyzer automatically name it.</p>
Real	<p>Softkey in the more format menu. Displays only the real (resistive) portion of the measured data on a Cartesian format. This is similar to the linear magnitude format, but can show both positive and negative values.</p> <p>Access Keys: FORMAT More Format</p>

Recall Line	Softkey in the IBASIC edit menu. Access Keys: (SYSTEM OPTIONS) IBASIC Edit
Recall Program	Softkey in the programs menu. Recalls to the network analyzer a program from internal memory, internal disk, or external disk. See the <i>HP Instrument BASIC User's Handbook Supplement</i> for more information. Access Keys: (SAVE RECALL) Programs
Recall State	Softkey in the (SAVE RECALL) menu. Recalls instrument state files (not plot files) from internal memory or a floppy disk. See "Saving and Recalling Measurement Results" on page 4-57 for more information.
Reference Level	Softkey in the (SCALE) menu. Sets the value of the reference line. The reference value is noted on the screen as "Ref".
Reference Position	Softkey in the (SCALE) menu. Sets the position of the reference line from the top of the graticule (10) to the bottom (0) or in between. Default position is middle (5). See Figure 2-3 on page 2-7 .
Reference Tracking	Softkey in the (SCALE) menu. Allows you to track either a certain frequency or the peak point of the measurement trace by scaling the trace such that the point of interest always falls on the display reference line. See "Using Reference Tracking" on page 4-42 for more information.
Reflection	<i>(Option 100 only)</i> Softkey in the cable menu. Selects the S ₁₁ (forward reflection) type of measurement. See "Using the BEGIN Key to Configure Measurements" on page 3-17 for more information. Access Keys: (BEGIN) Cable

<p>Remote IP Addr/Host</p>	<p>Softkey in the automount setup menu and the mount NFS device menu. Displays a dialog box for entering the remote host name (or host IP address) for an NFS device.</p> <p>Access Keys: SYSTEM OPTIONS LAN NFS Device Setup , Automount Setup or Mount NFS Device</p> <p>This softkey also appears in the automount dev table menu and the NFS device table menu. Displays an <i>expanded</i> version of the remote file system information found in the automount device table and the NFS device table.</p> <p>Access Keys: SYSTEM OPTIONS LAN NFS Device Setup NFS Device Table</p> <p>or</p> <p>SYSTEM OPTIONS LAN NFS Device Setup Automount Setup Automount Device Table</p> <p>See <i>The LAN Interface User's Guide Supplement</i> for more information.</p>
<p>Remote Path</p>	<p>Softkey in the automount setup menu and the mount NFS device menu. Displays a dialog box for entering the remote host file system name for an NFS device.</p> <p>Access Keys: SYSTEM OPTIONS LAN NFS Device Setup Automount Setup or Mount NFS Device</p> <p>See <i>The LAN Interface User's Guide Supplement</i> for more information.</p>

<p>Remote Path Host</p>	<p>Softkey in the automount dev table menu and the NFS device table menu. Displays an <i>expanded</i> version of the remote file system information found in the automount device table and the NFS device table.</p> <p>Access Keys:</p> <p>(SYSTEM OPTIONS) LAN NFS Device Setup NFS Device Table</p> <p>or</p> <p>(SYSTEM OPTIONS) LAN NFS Device Setup Automount Setup Automount Device Table</p> <p>See <i>The LAN Interface User's Guide Supplement</i> for more information.</p>
<p>Remove Automount</p>	<p>Softkey in the automount setup menu. Displays the automount device table, which lists the currently automounted NFS devices. Highlight the device you want to remove from the table and press the softkey which corresponds to that device.</p> <p>See <i>The LAN Interface User's Guide Supplement</i> for more information.</p> <p>Access Keys: (SYSTEM OPTIONS) LAN NFS Device Setup Automount Setup</p>
<p>Remove Directory</p>	<p>Softkey in the directory utilities menu. Allows you to delete empty directories only. Highlight the intended directory, then press this softkey.</p> <p>See "To Use Directory Utilities" on page 4-67 for more information.</p> <p>Access Keys: (SAVE RECALL) File Utilities Directory Utilities</p>
<p>Remove Pattern</p>	<p>Softkey in the CRT adjust menu. A test pattern is displayed whenever the CRT Adjust key is pressed. Use this key to remove the test pattern from the display.</p> <p>Access Keys: (SYSTEM OPTIONS) System Config CRT Adjust</p>
<p>Rename File</p>	<p>Softkey in the file utilities menu. Displays the character entry menu to rename the highlighted file.</p> <p>See "Other File Utilities" on page 4-65 for more information.</p> <p>Access Keys: (SAVE RECALL) File Utilities</p>

Response	<p>Softkey in the response cal menu when in S_{21} or S_{12} (transmission) measurement mode. Select this key to perform a user-defined response calibration. Restores a previous response calibration if current analyzer parameters are compatible with those used during the previous calibration. Corrects for frequency response errors.</p> <p>See Chapter 6 for more information.</p> <p>Access Keys: CAL User Response</p>
Response & Isolation	<p>Softkey in the response cal menu when in S_{21} or S_{12} (transmission) measurement mode. Select this key to perform a user-defined response & isolation calibration. Restores a previous response & isolation calibration if current analyzer parameters are compatible with those used during the previous calibration. Corrects for frequency response and isolation errors. Isolation errors result from leakage between signal paths (crosstalk).</p> <p>See Chapter 6 for more information.</p> <p>Access Keys: CAL User Response</p>
Restart Average	<p>Softkey in the AVG menu. Clears the running average and restarts it with the next sweep.</p> <p>See “To Reduce the Receiver Noise Floor” on page 5-10 for information on averaging.</p>

<p>Restore Defaults</p>	<p>Softkey in several HARDCOPY menus, the CRT adjust menu, the SICL LAN setup menu, and the SCPI sock. setup menu.</p> <p>If this key is pressed in the HARDCOPY menus, it resets parameters such as addresses, baud rates, handshakes, color, pens, resolution, and margins to predetermined values.</p> <p>See “Printing and Plotting Measurement Results” on page 4-80 for more information on using the HARDCOPY menu.</p> <p>If this key is pressed in the CRT adjustment menu, it restores the default CRT timing values.</p> <p>If this key is pressed in the SCPI sock. setup menu or the SICL LAN setup menu, it resets the socket port number or the GPIB device address, GPIB logical unit number, and GPIB name, respectively, to predetermined values.</p> <p>See <i>The LAN Interface User's Guide Supplement</i> for more information.</p>
<p>RF Filter Stats</p>	<p>Softkey in the marker math menu. Measures both the passband and stopband of a filter in one sweep.</p> <p>See “To Use Marker Math Functions” on page 4-18 for more information.</p> <p>Access Keys: MARKER Marker Functions Marker Math</p>
<p>RF ON off</p>	<p>Softkey in the POWER menu. Turns the internal RF source off and on. Default is on.</p>
<p>Round Seconds</p>	<p>Softkey in the set clock menu. Rounds off seconds to the nearest minute. Rounds down with less than 30 seconds; rounds up to next minute with more than 30 seconds.</p> <p>Access Keys: SYSTEM OPTIONS System Config Set Clock</p>
<p>Run</p>	<p>Softkey in the IBASIC menu that starts a program.</p> <p>See the <i>HP Instrument BASIC User's Handbook Supplement</i> for more information.</p> <p>Access Keys: SYSTEM OPTIONS IBASIC</p>

S

S11 Refl Port1	<p>Softkey in the amplifier, filter, broadband passive, mixer, and measurement menus. Selects the S_{11} (forward reflection) type of measurement. Power is output from the analyzer's port 1 and also measured there.</p> <p>See "Measuring S11 Reflection Port 1 using a One-Port Calibration" on page 3-49 for more information.</p> <p>Access Keys: MEAS 1 or MEAS 2. Also BEGIN, Amplifier or Filter or Broadband Passive or Mixer</p>
S21 Fwd Trans	<p>Softkey in the amplifier, filter, broadband passive, and measurement menus. Selects the S_{21} (forward transmission) type of measurement. Power is output from the analyzer's port 1 and measured at the analyzer's port 2.</p> <p>See "Measuring S21 Forward Transmission using an Enhanced Response Calibration" on page 3-42 for more information.</p> <p>Access Keys: MEAS 1 or MEAS 2. Also BEGIN, Amplifier or Filter or Broadband Passive</p>
S12 Rev Trans	<p>Softkey in the amplifier, broadband passive, and measurement menus. Selects the S_{12} (reverse transmission) type of measurement. Power is output from the analyzer's port 2 and measured at the analyzer's port 1.</p> <p>See "Measuring S21 Forward Transmission using an Enhanced Response Calibration" on page 3-42 for more information on a similar (S_{21}) measurement.</p> <p>Access Keys: MEAS 1 or MEAS 2. Also BEGIN, Amplifier or Filter or Broadband Passive</p>

S22 Refl Port2	<p>Softkey in the amplifier, broadband passive, and measurement menus. Selects the S_{22} (reverse reflection) type of measurement. Power is output from the analyzer's port 2 and also measured there.</p> <p>See “Measuring S11 Reflection Port 1 using a One-Port Calibration” on page 3-49 for more information on a similar (S_{11}) measurement.</p> <p>Access Keys: MEAS 1 or MEAS 2. Also BEGIN, Amplifier or Broadband Passive</p>
Saturation	<p>Softkey in the custom colors menu. Use this key to customize the colors of display items on your external monitor. Saturation is the amount of pure color (selected with the Hue key) to be mixed with white. Saturation values are expressed as a percentage: 0 to 100%, with 0 representing no color, and 100 representing no white.</p> <p>See “Using an External VGA Monitor” on page 4-89 for more information.</p> <p>Access Keys: DISPLAY More Display Color Options Custom Colors</p>
Save ASCII	<p>Softkey in the define save menu. Selects which measurement channel's (1 or 2) trace data is to be saved in ASCII format for output. Also allows you to choose whether to save in Lotus 123 or Touchstone format for spreadsheet use.</p> <p>See “Saving and Recalling Measurement Results” on page 4-57 for more information.</p> <p>Access Keys: SAVE RECALL Define Save</p>
Save AUTOST	<p>Softkey in the programs menu. Titles the current program AUTOST and saves it to internal RAM or a 3.5” disk as set by Select Disk. At power-up, the network analyzer searches the internal non-volatile RAM disk and the floppy disk in the analyzer's built-in disk drive for an AUTOST (auto-start) file, loads it, and executes it if present.</p> <p>Access Keys: SAVE RECALL Programs</p>

Save Meas 1	<p>Softkey in the save ASCII menu. Selects measurement channel 1 data to be saved as ASCII data. This data can be imported into a spreadsheet or word processing program.</p> <p>See “Saving and Recalling Measurement Results” on page 4-57 for more information.</p> <p>Access Keys: SAVE RECALL Define Save Save ASCII</p>
Save Meas 2	<p>Softkey in the save ASCII menu. Selects measurement channel 2 data to be saved as ASCII data. This data can be imported into a spreadsheet or word processing program.</p> <p>See “Saving and Recalling Measurement Results” on page 4-57 for more information.</p> <p>Access Keys: SAVE RECALL Define Save Save ASCII</p>
Save Program	<p>Softkey in the programs menu. Saves the current program to internal RAM or 3.5” disk.</p> <p>See the <i>HP Instrument BASIC User's Handbook Supplement</i> for more information.</p> <p>Access Keys: SAVE RECALL Programs</p>
SAVE RECALL	<p>Hardkey in the SYSTEM area of the front panel. Displays menus to: save, title, define, and recall states and programs; rename, delete, and copy files; select, configure, and format disks.</p> <p>See “Saving and Recalling Measurement Results” on page 4-57 for examples.</p>
Save State	<p>Softkey in the SAVE RECALL menu. Saves information to internal RAM or 3.5” disk, automatically naming the file "STATE#."</p> <p>See “Saving and Recalling Measurement Results” on page 4-57 for more information.</p>
SCALE	<p>Hardkey in the CONFIGURE area of the front panel. Allows changing of scale per division, reference level, and reference position for optimum viewing of measurements. Also accesses the reference tracking, phase offset, and electrical delay functions.</p> <p>See “Entering Measurement Parameters” on page 2-4, and “Using Reference Tracking” on page 4-42 for more information.</p>

Scale/Div	Softkey in the SCALE menu. Sets the value of vertical divisions of graticule. For example, if the scale/div is 10 dB, each graticule line is 10 dB higher than the one below.
SCPI Sock. Setup	Softkey in the LAN menu. Displays the menu to set up the socket port number. This socket port number is used for making socket connections to the analyzer for SCPI socket programming. See <i>The LAN Interface User's Guide Supplement</i> for more information.
Search Left	Softkey in the target search menu. During a target search, moves the active marker to the left (lower frequency) to the first occurrence on the data trace where the amplitude equals the target value. That first occurrence may be an actual data point or an interpolated value. See "To Use Marker Search Functions" on page 4-7 for an example of how to use the target search function. Access Keys: MARKER Marker Search Target Search
Search Off	Softkey in marker search more menu. Disables marker search. See "Using Markers" on page 4-3 for more information on using marker search functions. Access Keys: MARKER Marker Search More
Search Right	Softkey in the target search menu. During a target search, moves the active marker to the right (higher frequency) to the first occurrence on the data trace where the amplitude equals the target value. That first occurrence may be an actual data point or an interpolated value. See "To Use Marker Search Functions" on page 4-7 for an example of how to use the target search function. Access Keys: MARKER Marker Search Target Search
Seconds ON off	Softkey in the clock format menu. Toggles on and off the seconds annotation that is displayed or printed as part of the clock. Access Keys: SYSTEM OPTIONS System Config Set Clock Clock Format

Secure	<p>Softkey in the utilities menu. Enables the user to define part or all of a program by start and end lines. Once secured, the defined lines can not be listed, seen, or edited.</p> <p>See the <i>HP Instrument BASIC User's Handbook Supplement</i> for more information.</p> <p>Access Keys: (SYSTEM OPTIONS) IBASIC Utilities</p>
Select	<p>Softkey in the select copy port menu. Selects the hardcopy port device highlighted in the select copy port list.</p> <p>See “Connecting and Configuring Printers and Plotters” on page 4-70 for more information.</p> <p>Access Keys: (HARDCOPY) Select Copy Port</p>
Select Char	<p>Softkey in the character entry menu. Adds the character selected by the pointer to the end of a title or file name.</p>
Select Char/Word	<p>Softkey in the insert line and insert character menus. Adds character or word selected by pointer to an IBASIC program.</p> <p>Access Keys: (SYSTEM OPTIONS) IBASIC Edit Insert Line <i>or</i> Insert Char</p>
Select Copy Port	<p>Softkey in the (HARDCOPY) menu. Displays the menu to select the hardcopy output device and its operating parameters. Default settings (not affected by preset) are HP printer, PCL language, parallel port. Use the front panel knob or arrow keys to highlight the device, then press Select.</p> <p>NOTE _____ "Baud Rate," "Xon/Xoff," and "DTR/DSR" apply only to serial devices.</p> <p>See “Connecting and Configuring Printers and Plotters” on page 4-70 for more information.</p>
Select Disk	<p>Softkey in the (SAVE RECALL) menu. Displays the menu to select the type of memory location to save to or recall from: non-volatile RAM disk, volatile RAM disk, or internal 3.5" disk. Also allows configuration of the volatile RAM disk.</p> <p>See “Saving and Recalling Measurement Results” on page 4-57 for more information.</p>

Select Item	<p>Softkey in the custom colors menu. Selects the item whose color you want to customize on the external VGA monitor. Use the front panel knob, the keypad, or the arrow keys to specify the item number you want to customize.</p> <p>See “Using an External VGA Monitor” on page 4-89 for more information.</p> <p>Access Keys: DISPLAY More Display Color Options Custom Colors</p>
Service	<p>Softkey in the SYSTEM OPTIONS menu. Displays softkeys for menus related to service. Also includes Instrument Info, which displays instrument information.</p> <p>See the <i>Service Guide</i> for more information.</p>
Service Utilities	<p>Softkey in the service menu. Displays the menu of service functions.</p> <p>See the <i>Service Guide</i> for details.</p> <p>Access Keys: SYSTEM OPTIONS Service</p>
Set Clock	<p>Softkey in the system configure menu. Displays the menu to set the real-time internal clock of the network analyzer and its format.</p> <p>Access Keys: SYSTEM OPTIONS System Config</p>
Set Day	<p>Softkey in the set clock menu. Sets the day of the month.</p> <p>Access Keys: SYSTEM OPTIONS System Config Set Clock</p>
Set Hour	<p>Softkey in the set clock menu. Sets the hour value on the clock.</p> <p>Access Keys: SYSTEM OPTIONS System Config Set Clock</p>
Set Minute	<p>Softkey in the set clock menu. Sets the minute value on the clock.</p> <p>Access Keys: SYSTEM OPTIONS System Config Set Clock</p>

<p>Set Month</p>	<p>Softkey in the set clock menu. Sets the month on the clock.</p> <hr/> <p>NOTE When selecting the month, you will always input a number that corresponds to the month desired. If the clock format is set to "alpha," however, the displayed month will be a three letter abbreviation (such as Mar for March).</p> <hr/> <p>Access Keys: (SYSTEM OPTIONS) System Config Set Clock</p>
<p>Set Pen Numbers</p>	<p>Softkey in the define plotter menu. Displays the set pen numbers menu to assign pen numbers to items to be plotted (like traces, graticule, etc.). In the color setting, different items can be plotted with different pens. In the monochrome setting, all items are printed with the same pen.</p> <p>See “Connecting and Configuring Printers and Plotters” on page 4-70 for more information.</p> <p>Access Keys: (HARDCOPY) Define Plotter</p>
<p>Set Track Frequency</p>	<p>Softkey in the reference tracking menu. Allows you to identify a particular frequency as a point of interest. After the frequency point is set, and frequency tracking is turned on by pressing Track Frequency, the analyzer will always place the frequency point of interest on the display reference line.</p> <p>See “Using Reference Tracking” on page 4-42 for more information.</p> <p>Access Keys: (SCALE) Reference Tracking</p>
<p>Set Year</p>	<p>Softkey in the set clock menu. Sets the year on the clock.</p> <p>Access Keys: (SYSTEM OPTIONS) System Config Set Clock</p>
<p>Short</p>	<p>Softkey in the modify kit menu. Allows you to modify the following characteristics of the short calibration standard in your calibration kit: delay, loss, and Z_0.</p> <p>See “Calibration Kits” on page 6-23 for more information.</p> <p>Access Keys: (CAL) More Cal Cal Kit Modify (connector type)</p>

Show Clock on Line 1	<p>Softkey in the title and clock menu. Displays the clock on the uppermost line of the title area when Title+Clk ON off is toggled ON.</p> <p>Access Keys: DISPLAY More Display Title and Clock</p>
Show Clock on Line 2	<p>Softkey in the title and clock menu. Displays the clock on the uppermost line of the title area when Title+Clk ON off is toggled ON.</p> <p>Access Keys: DISPLAY More Display Title and Clock</p>
SICL LAN Setup	<p>Softkey in the LAN menu. Displays the menu to setup the GPIB device address, GPIB logical unit number, and GPIB name for SICL LAN control of the analyzer.</p> <p>See <i>The LAN Interface User's Guide Supplement</i> for more information.</p>
Single	<p>Softkey in the trigger menu. Immediately stops the current sweep, takes one complete sweep, and holds until retriggered by pressing Single again, or Continuous.</p> <p>Access Keys: MENU Trigger</p>
Smith Chart	<p>Softkey in the format menu. A reflection measurement display format that maps the complex reflection coefficient (ρ) to the DUT's impedance.</p> <p>See “Measuring Impedance using the Smith Chart” on page 3-74 for more information.</p>
Smith Chart Z0	<p>Sets the characteristic impedance used by the analyzer in calculating measured impedance with Smith chart markers and conversion parameters. Characteristic impedance must be set correctly before calibrating for a Smith chart measurement. Acceptable values are 1 ohm to 1000 ohms.</p> <p>Access Keys: CAL More Cal</p>
Socket Port No.	<p>Softkey in the SCPI sock. setup menu. Allows you to enter the port number for a socket connection to the analyzer for SCPI socket programming. The default port number is 5025.</p> <p>See <i>The LAN Interface User's Guide Supplement</i> for more information.</p>

<p>Softkey Auto-Step</p>	<p>Softkey in the user TTL config menu. Displays a pop-up message with a description of softkey sequencing and softkeys to enable or disable the auto-step function.</p> <p>See "Measurement Setup and Control with Fast Recall" in the <i>Automating Measurements User's Guide Supplement</i> for more information.</p> <p>Access Keys: SYSTEM OPTIONS System Config User TTL Config</p>
<p>Space</p>	<p>Softkey in the character entry menu. Adds a blank space to a title or filename.</p>
<p>Span</p>	<p>Softkey in the FREQ menu. Used in conjunction with Center. Selects the frequency span of the source. When selected, it changes the frequency annotation from start/stop to center/span.</p> <p>See "Entering Measurement Parameters" on page 2-4 for more information.</p>
<p>Split Disp FULL split</p>	<p>Softkey in the more display menu. Toggles the display mode between split (measurement channel 1 on top, measurement channel 2 on the bottom) and full (both measurement channels on full screen).</p> <p>See "Entering Measurement Parameters" on page 2-4 for more information.</p> <p>Access Keys: DISPLAY More Display</p>
<p>Spur Avoid</p>	<p>Softkey in the spur avoid options menu. If this option is selected, the analyzer switches between the default and an alternate configuration during a sweep to avoid spurs.</p> <p>NOTE Sweeptime usually increases when this option is selected.</p> <p>See "Reducing Trace Noise" on page 5-12 for more information.</p> <p>CAUTION The measurement calibration must be performed with the same spur avoid option used in the measurement or your results may be invalid.</p> <p>Access Keys: MENU Spur Avoid Options</p>

Spur Avoid Options	Softkey in the source (MENU) . Displays selections for spur avoidance: dither, spur avoid, or none.
SRL	<i>(Option 100 only)</i> Softkey in the cable or measurement menus. Selects the structural return loss (SRL) measurement. See your <i>Option 100 User's Guide Supplement</i> for information. Access Keys: (BEGIN) Cable or (MEAS 1) or (MEAS 2)
Stack Size	Softkey in the utilities menu. Allows you to set the number of bytes in the stack size by using the analyzer's numeric keypad. Access Keys: (SYSTEM OPTIONS) IBASIC Utilities
Start	Softkey in two menus: (FREQ) and (HARDCOPY) . 1. In (FREQ) menu, sets the start frequency of the source. Minimum frequency is 300 kHz. When start is selected, the other frequency parameter that must be defined is stop. See “Entering Measurement Parameters” on page 2-4 for more information. 2. In (HARDCOPY) menu, starts print or plot as set in the select copy port menu. See “Printing and Plotting Measurement Results” on page 4-80 for more information.
Start Line #	Softkey in the secure menu that is used with the IBASIC feature of the instrument. See the <i>HP Instrument BASIC User's Handbook</i> for information on the secure function. Access Keys: (SYSTEM OPTIONS) IBASIC Utilities Secure
Start Power	Softkey in the (POWER) menu. Sets the starting point (in dBm) for a power sweep measurement. Power Sweep in the (SWEEP) menu must be selected before setting the start and stop power points. See the Power Sweep entry in this chapter for more information on the power sweep function.

Statistics	<p>Softkey in the marker math menu. Measures a user-defined segment of a measurement trace and calculates the frequency span, mean, and standard deviation of the amplitude response, and the peak-to-peak ripple.</p> <p>See “To Use Marker Math Functions” on page 4-18 for more information.</p> <p>Access Keys: MARKER Marker Functions Marker Math</p>
Step	<p>Softkey in the IBASIC menu. When a program is ready to run, this softkey allows you to step through the program one line at a time. A good de-bugging tool.</p> <p>See the <i>HP Instrument BASIC User's Handbook Supplement</i> for more information.</p> <p>Access Keys: SYSTEM OPTIONS IBASIC</p>
Step Sweep on OFF	<p>Softkey in the SWEEP menu. Toggle to ON to allow the analyzer to sweep in steps. When toggled OFF, the analyzer sweeps continuously. A stepped sweep allows greater measurement accuracy and eliminates frequency shift problems when measuring devices with long electrical delay. The disadvantage of a stepped sweep is the slower sweep speed.</p>
Stop	<p>Softkey in the FREQ menu. Sets the stop frequency of the source. Maximum frequency is 1.3 GHz for the 8712ES and 3.0 GHz for the 8714ES.</p>
Stop Power	<p>Softkey in the POWER menu. Sets stopping point (in dBm) for a power sweep measurement. Power Sweep in SWEEP menu must be selected before setting the start and stop power points.</p> <p>See the Power Sweep entry in this chapter for more information on the power sweep function.</p>
Store CC To Disk	<p>Softkey in the update correction constants menu. Writes a copy of CC data from internal volatile RAM to a 3.5" disk in the analyzer's built-in disk drive. This function is used to make a backup copy of CC data.</p> <p>See the <i>Service Guide</i> for more information.</p> <p>Access Keys: SYSTEM OPTIONS Service Update Corr Const</p>

<p>Store CC To EPROM</p>	<p>Softkey in the update correction constants menu. Writes a copy of CC data from internal volatile RAM to EPROM. This function is used so that current CC data is not lost when power to the analyzer is turned off.</p> <p>See the <i>Service Guide</i> for more information.</p> <p>Access Keys: (SYSTEM OPTIONS) Service Update Corr Const</p>
<p>Subnet Mask</p>	<p>Softkey in the LAN port setup menu. Allows you to enter the numbers that your network administrator assigned to your analyzer. If you were not assigned a subnet mask, leave the setting at 0.0.0.0 (default value) to disable subnet masking.</p> <p>See <i>The LAN Interface User's Guide Supplement</i> for more information.</p> <p>Access Keys: (SYSTEM OPTIONS) LAN LAN Port Setup</p>
<p>(SWEEP)</p>	<p>Hardkey in the SOURCE area of the front panel. Displays the menu to select automatic sweep time (fastest possible), manual sweep, alternate sweep, or power sweep.</p>
<p>Sweep Out</p>	<p>Softkey in the user TTL config menu. Sets the USER TTL IN/OUT port on the rear panel to be pulled to a high TTL level during a sweep.</p> <p>See “Analyzer Connectors—Rear Panel BNC Connectors” on page 7-4 for more information.</p> <p>Access Keys: (SYSTEM OPTIONS) System Config User TTL Config</p>
<p>Sweep Time</p>	<p>Softkey in the (SWEEP) menu. Sets the sweep time from fastest possible to three days (259.2 ks); overrides auto sweep time. Fastest possible sweeptime varies, and depends on other analyzer settings.</p> <p>See Chapter 5 for more information on sweep time.</p>
<p>Sweep Time AUTO man</p>	<p>Softkey in the (SWEEP) menu. Sets the network analyzer to sweep as fast as possible (automatic) or at the sweep time of your choice (manual).</p> <p>See Chapter 5 for more information on sweep time.</p>

Switching Test Set	<p>Softkey in the system config menu. Configures the analyzer for use with a multiport test set.</p> <p>Refer to the multiport test set <i>User's and Service Guide</i> for more information.</p> <p>Access Keys: SYSTEM OPTIONS System Config</p>
SWR	<p>Softkey in the FORMAT menu. Displays the data formatted as SWR (standing wave ratio).</p>
Sync Green on OFF	<p>Softkey in the CRT adjust menu. Toggle to ON for use with a sync-on-green external monitor. The default setting is toggled to OFF.</p> <p>Access Keys: SYSTEM OPTIONS System Config CRT Adjust</p>
System Bandwidth	<p>Softkey in the AVG menu. Displays the menu to set the bandwidth of the IF filters in the receiver section of the network analyzer.</p> <p>See “To Reduce the Receiver Noise Floor” on page 5-10 and the following table for more information on system bandwidth.</p>

System BW	Dynamic Range	Sweep Speed	Approximate BW
Wide	Low	Fastest	6500 Hz
Medium Wide (default)	Medium	Faster	4000 Hz
Medium	Medium	Fast	3700 Hz
Medium Narrow	Medium	Slow	1200 Hz
Narrow	High	Slower	250 Hz
Fine	High	Slowest	15 Hz

System Config	Softkey in the SYSTEM OPTIONS menu. Displays the menu to adjust the clock setting, set the beeper volume, adjust the CRT settings, and configure the rear panel USER TTL IN/OUT port.
System Controller	Softkey in the GPIB menu. Makes the network analyzer the system controller of the general purpose instrument bus. Required mode for interfacing with GPIB peripherals (printers, plotters, and disk drives). Also required by IBASIC to talk to GPIB peripherals. This operation mode is not selectable with another active controller on the bus. See the <i>Programmer's Guide</i> for more information. Access Keys: SYSTEM OPTIONS GPIB
SYSTEM OPTIONS	Hardkey in the SYSTEM area of front panel.
System Z0	Softkey in the cal kit menu. Provides access to the system impedance menu. Refer to “When to Change the System Impedance” on page 3-13 for more information. Access Keys: CAL More Cal

T

Talker Listener	Softkey in the GPIB menu. Makes the analyzer the talker/listener on the general purpose instrument bus. The analyzer cannot talk directly with other peripherals in this mode unless the computer establishes a data path for it. GPIB mode is normally used for remote (computer) control of the analyzer. Access Keys: (SYSTEM OPTIONS) GPIB
Target Search	Softkey in the marker search menu. Displays the menu to set the target search value, search left, or search right. See “Using Markers” on page 4-3 for more information. Access Keys: (MARKER) Marker Search
Target Value	Softkey in the target search menu. Sets the value of the target sought by Search Left or Search Right . Default value is -3 dB. NOTE Since markers are continuous but frequency points are discrete, target values may be interpolated. See “Using Markers” on page 4-3 for more information. Access Keys: (MARKER) Marker Search Target Search
Tests and Adjustments	Softkey in the service menu. Displays the menu to perform tests, including self-tests, and adjustments. See the <i>Service Guide</i> for information on tests and adjustments. Access Keys: (SYSTEM OPTIONS) Service
TFTP	Softkey in the BOOTP setup menu. Selects TFTP as the file transfer protocol used to transfer a boot file from a BOOTP server to the analyzer. See <i>The LAN Interface User's Guide Supplement</i> for more information. Access Keys: (SYSTEM OPTIONS) LAN BOOTP Setup

Timeout	<p>Softkey in the BOOTP setup menu. Allows you to set the number of seconds your analyzer will wait for a BOOTP reply at boot time. The analyzer will retransmit the BOOTP request during this period if it gets no reply. The retransmission time increases exponentially but is bounded.</p> <p>See <i>The LAN Interface User's Guide Supplement</i> for more information.</p> <p>Access Keys: SYSTEM OPTIONS LAN BOOTP Setup</p>
Thru	<p>Softkey in the modify kit menu. Allows you to modify the following characteristics of the thru calibration standard in your calibration kit: delay, loss, and Z_0.</p> <p>See "Calibration Kits" on page 6-23 for more information.</p> <p>Access Keys: CAL More Cal Cal Kit Modify (connector type) Broadband Passive</p>
Title+Clk ON off	<p>Softkey in the title and clock menu. Used to show the title (if any) and date/time on the display and/or on a hardcopy output.</p> <p>Access Keys: DISPLAY More Display Title and Clock <i>or</i> HARDCOPY Define Hardcopy Define Graph</p>
Title and Clock	<p>Softkey in the more display menu. Displays the menu to display and edit the screen title and display clock.</p> <p>Access Keys: DISPLAY More Display</p>
Top Margin	<p>Softkey in the more printer menu. Sets the top margin of the printout (non-printing space) in mm. Minimum setting is 0.00 mm (default); maximum setting is 200.00 mm.</p> <p>Access Keys: HARDCOPY Define Printer More Printer</p>
Touchstone Format	<p>Softkey in the save ASCII menu. Also known as S2P data format. Saves measurement data in a format compatible with CAE programs.</p> <p>See "Saving Instrument Data" on page 4-59 for more information.</p> <p>Access Keys: SAVE RECALL Define Save Save ASCII</p>

Trace 1 Pen	<p>Softkey in the set pen numbers menu. Sets the pen number assignment for data trace 1 on the hardcopy. Different pen numbers can represent different color or width pens.</p> <p>See “Connecting and Configuring Printers and Plotters” on page 4-70 for more information.</p> <p>Access Keys: HARDCOPY Define Plotter Set Pen Numbers</p>
Trace 2 Pen	<p>Softkey in the set pen numbers menu. Sets the pen number assignment for data trace 2 on the hardcopy. Different pen numbers can represent different color or width pens.</p> <p>See “Connecting and Configuring Printers and Plotters” on page 4-70 for more information.</p> <p>Access Keys: HARDCOPY Define Plotter Set Pen Numbers</p>
Trace Data ON off	<p>Softkey in the define graph menu. When toggled ON (default setting), prints or plots measurement trace data when Graph and Mkr Table or Graph Only is selected.</p> <p>Access Keys: HARDCOPY Define Hardcopy Define Graph</p>
Track Frequency	<p>Softkey in the reference tracking menu. Displays the measurement trace, which is rescaled with each sweep so that the selected frequency (set with the Set Track Frequency key) is placed on the reference line.</p> <p>See “Using Reference Tracking” on page 4-42 for more information.</p> <p>Access Keys: SCALE Reference Tracking</p>
Track Peak	<p>Softkey in the reference tracking menu. Displays the measurement trace, which is rescaled with each sweep so that the peak point on the trace lies on the display reference line.</p> <p>See “Using Reference Tracking” on page 4-42 for more information.</p> <p>Access Keys: SCALE Reference Tracking</p>

Tracking on OFF	<p>Softkey in the marker search menu. Toggle to ON if you want the marker search functions to be updated with each sweep. When toggled OFF (default setting), the functions are performed only once, when selected.</p> <p>See “Using Markers” on page 4-3 for more information.</p> <p>Access Keys: (MARKER) Marker Search</p>
Port 1 Extension	<p>Softkey in the port extensions menu. Allows compensation for phase shift due to an extended measurement reference plane on port 1.</p> <p>See “Port Extensions” on page 5-18 for more information.</p> <p>Access Keys: (CAL) More Cal Port Extensions Port Ext’s on OFF</p>
Port 2 Extension	<p>Softkey in the port extensions menu. Allows compensation for phase shift due to an extended measurement reference plane on port 2.</p> <p>See “Port Extensions” on page 5-18 for more information.</p> <p>Access Keys: (CAL) More Cal Port Extensions Port Ext’s on OFF</p>
Transmissn	<p><i>(Option 100 only)</i> Softkey in the cable menu. Selects the S_{21} (forward transmission) type of measurement.</p> <p>See “Using the BEGIN Key to Configure Measurements” on page 3-17 for more information.</p> <p>Access Keys: (BEGIN) Cable</p>
Trigger	<p>Softkey in the source (MENU). Displays the menu with choices for triggering the analyzer. The analyzer can be triggered continuously (default setting) or once. It can be triggered internally (default setting), externally, or externally one frequency point at a time.</p>
Trigger Source	<p>Softkey in the trigger menu. Displays the menu for the choice of internal or external triggering.</p> <p>Access Keys: (MENU) Trigger</p>

<p>TSet Cal on OFF</p>	<p>Softkey in the define save menu. For use with a multiport test set. Toggle to ON if you want to save the TSet Cal.</p> <p>Refer to the multiport test set <i>User's and Service Guide</i> for more information.</p> <p>Access Keys: SAVE RECALL Define Save</p>
<p>Type-F</p>	<p>Softkey in the cal kit menu of 75 ohm instruments. Selects the type of cal kit as type-F.</p> <p>See “Calibration Kits” on page 6-23 for more information.</p> <p>Access Keys: CAL More Cal Cal Kit</p> <hr/> <p>NOTE By convention, cal kits indicate the sex of the <i>port</i> with which they are used. For example, the default cal kit for the analyzer is type-N <i>female</i> because the front panel RF ports are female (the calibration standards, in turn, have male connectors).</p>
<p>Type-N(f) (Default)</p>	<p>Softkey in the cal kit menu. Selects the type of cal kit as type-N(f). Also known as the default cal kit.</p> <p>See the Note in the Type-F description above.</p> <p>See “Calibration Kits” on page 6-23 for more information.</p> <p>Access Keys: CAL More Cal Cal Kit</p>
<p>Type-N(m)</p>	<p>Softkey in the cal kit menu. Selects the type of cal kit as type-N(m).</p> <p>See the Note in the Type-F description above.</p> <p>See “Calibration Kits” on page 6-23 for more information.</p> <p>Access Keys: CAL More Cal Cal Kit</p>

U

<p>Unmount NFS Device</p>	<p>Softkey in the NFS device setup menu. Displays the NFS device table, which lists the currently mounted NFS devices. Select the device you want to remove from the table and press the softkey which corresponds to that device.</p> <p>See <i>The LAN Interface User's Guide Supplement</i> for more information.</p> <p>Access Keys: (SYSTEM OPTIONS) LAN NFS Device Setup</p>
<p>Update Corr Const</p>	<p>Softkey in the service menu. Displays a menu to store correction constants to a 3.5" floppy disk or internal non-volatile memory, or to load correction constants from a disk.</p> <p>See the <i>Service Guide</i> for more information.</p> <p>Access Keys: (SYSTEM OPTIONS) Service</p>
<p>Upper</p>	<p>Softkey in the IBASIC display menu. Displays the IBASIC program on the upper half of the screen and measurement data on the lower half.</p> <p>Access Keys: (SYSTEM OPTIONS) IBASIC IBASIC Display</p>
<p>User 1-Port</p>	<p>Softkey in the (CAL) menu when in S_{11} or S_{22} (reflection) measurement mode. Displays the one-port reflection cal menu which shows more calibration choices: Default 1-Port or User 1-Port . Press User 1-Port to perform a user-defined one-port calibration. Restores a previous user one-port calibration if current analyzer parameters are compatible with those used during the previous calibration. Corrects for directivity, source match, and frequency response errors.</p> <p>See "Measuring S11 Reflection Port 1 using a One-Port Calibration" on page 3-49 for more information.</p>

User 2-Port	<p>Softkey in the CAL or User 2-Port . Press User 2-Port to perform a user-defined two-port calibration. Restores a previous user two-port calibration if current analyzer parameters are compatible with those used during the previous calibration. Corrects for directivity, source match, load match and frequency response errors. Also corrects for crosstalk errors when the Isolation on OFF key is selected.</p> <p>See “Measuring S-Parameters using a Two-Port Calibration” on page 3-20 for more information.</p>
User BEGIN on OFF	<p>Softkey in the BEGIN menu.</p> <p>See “The User BEGIN Function” on page 3-19 for more information.</p>
User Cal Kit (A-J)	<p>Softkeys in the more cal kits menu. Assigns any of User Cal Kits A–J to the selected port in the cal kit table (viewable with Cal Kit and More Cal Kits).</p> <p>See “Calibration Kits” on page 6-23 for more information.</p> <p>Access Keys: CAL More Cal Cal Kit More Cal Kits</p>
User ID	<p>Softkey in the authentication menu. Allows you to enter a User ID for your NFS remote file system. The default User ID value is 2001.</p> <p>See <i>The LAN Interface User's Guide Supplement</i> for more information.</p> <p>Access Keys: SYSTEM OPTIONS LAN NFS Device Setup Authentication</p>
User Name	<p>Softkey in the add login user menu and delete login user menu. Displays a dialog box for entering a login user name to be added or deleted on the access list of your analyzer.</p> <p>See <i>The LAN Interface User's Guide Supplement</i> for more information.</p> <p>Access Keys: SYSTEM OPTIONS LAN Login User Setup , Add Login User or Delete Login User</p>

User Preset	<p>Softkey in the PRESET menu. Returns the analyzer to user-defined preset settings you may have saved as file <code>UPRESET.STA</code>. If this file doesn't exist, you can create it by following the instructions in the pop-up message that appears when the key is pressed.</p> <p>This key is for customers whose devices are damaged if subjected to the source conditions (power and frequency) of the factory preset.</p> <p>Reminder: the Pwr Level at Preset key allows you to modify the factory preset setting for power.</p>
User Response	<p>Softkey in the CAL menu when in S_{21}, or S_{12} (transmission) measurement mode. Displays the response calibration menu which shows more calibration choices: Default Response B, Response, Response & Isolation, or Enhanced Response.</p> <p>See Chapter 6 for more information on calibrating the analyzer.</p>
User TTL Config	<p>Softkey in the system config menu. Allows you to choose how the USER TTL IN/OUT rear panel connector will be utilized.</p> <p>See "Measurement Setup and Control with Fast Recall" in the <i>Automating Measurements User's Guide Supplement</i> for more information.</p> <p>Access Keys: SYSTEM OPTIONS System Config</p>
Utilities	<p>Softkey in the IBASIC menu. Enables user to clear program, set memory size, or secure programs.</p> <p>See the <i>HP Instrument BASIC User's Handbook Supplement</i> for more information.</p> <p>Access Keys: SYSTEM OPTIONS IBASIC</p>

V

Velocity Factor	<p>Softkey in the more cal menu. Enters the velocity factor used by the analyzer to calculate equivalent electrical length. Values entered should be less than 1, however the analyzer accepts values from 0.01 to 1.2.</p> <p>Access Keys: CAL More Cal</p>
Vertical Back Porch	<p>Softkey in the more CRT adjust menu. This is the CRT timing adjustment for use with external monitors. Also affects the network analyzer's internal CRT. Default setting is 31.84 μsec. This setting is not affected by an instrument preset.</p> <p>See “Using an External VGA Monitor” on page 4-89 for more information.</p> <p>Access Keys: SYSTEM OPTIONS System Config CRT Adjust More</p>
Vertical Frnt Porch	<p>Softkey in the more CRT adjust menu. This is the CRT timing adjustment for use with external monitors. Also affects the network analyzer's internal CRT. Default setting is 16.68416 msec. This setting is not affected by an instrument preset.</p> <p>See “Using an External VGA Monitor” on page 4-89 for more information.</p> <p>Access Keys: SYSTEM OPTIONS System Config CRT Adjust More</p>

<p>Vertical Position</p>	<p>Softkey in the CRT adjust menu. Changes the vertical positioning of the display on both the internal CRT and an external monitor. Accepts whole number values from 1 to 100, with 1 representing as far up as possible and with 100 representing as far down as possible. The default value set at the factory (and obtained by pressing Restore Defaults) is 74. This setting is not affected by an instrument preset.</p> <p>See “Using an External VGA Monitor” on page 4-89 for more information on using an external display.</p> <p>Access Keys: SYSTEM OPTIONS System Config CRT Adjust</p>
<p>Volatile RAM Disk</p>	<p>Softkey in the select disk menu. Selects the analyzer's internal volatile RAM as the place where information will be saved to or recalled from.</p> <p>CAUTION Any information stored on the volatile RAM disk will be lost if the analyzer's power is turned off.</p> <p>See “Saving and Recalling Measurement Results” on page 4-57 for more information.</p> <p>Access Keys: SAVE RECALL Select Disk</p>

W

Wide 6500 Hz

Softkey in the system bandwidth menu. This is the widest system bandwidth available. Medium wide bandwidth is the system default.

See [Chapter 5](#) for information on how system bandwidth can affect your measurements.

Access Keys: **AVG** **System Bandwidth**

X

X	<p>Softkey in the broadband external menu. Selects the diode detection type of measurement with an external detector connected to the EXT DET X-INPUT on the rear panel.</p> <p>Access Keys: MEAS 1 or MEAS 2, More Detection Options Broadband External</p>
X/Y	<p>Softkey in the broadband external menu. Selects the measurement of the ratio of external detectors at inputs X and Y.</p> <p>Access Keys: MEAS 1 or MEAS 2, More Detection Options Broadband External</p>
Xon/Xoff	<p>Softkey in the select copy port menu. A software handshake for some serial devices. Toggles with DTR/DSR.</p> <p>Access Keys: HARDCOPY Select Copy Port</p>

Y

Y	<p>Softkey in the broadband external menu. Selects the diode detection type of measurement with an external detector connected to the EXT DET Y-INPUT on the rear panel.</p> <p>Access Keys: MEAS 1 or MEAS 2 Detection Options Broadband External</p>
Y-Axis Lbl ON off	<p>Softkey in the more display menu. Toggle ON (default setting) to view the annotations to the left of the graticule: reference line indicator, graticule values, etc.</p> <p>NOTE</p> <p>Graticule values are limited to four characters including "." and "-". If any graticule value exceeds four characters, all values are blanked. For example, 23.45 blanks the values; it is not truncated as 23.4 or rounded up as 23.5. Similarly -1.23 blanks the graticule values.</p> <p>Access Keys: DISPLAY More Display Annotation Options</p>
Y-Axis Lbl rel ABS	<p>Softkey in the more display menu. Toggles the graticule value annotation and values: in ABS mode (default setting), the absolute value of each horizontal graticule line is indicated; in REL mode, the value of each horizontal graticule is indicated relative to the value of the reference line.</p> <p>Access Keys: DISPLAY More Display Annotation Options</p>

Y/R*	<p>Softkey in the broadband external menu. Selects the measurement of the ratio of the external detectors at inputs Y and R*.</p> <p>Access Keys: MEAS 1 or MEAS 2, More Detection Options Broadband External</p>
Y/X	<p>Softkey in the broadband external menu. Selects measurement of the ratio of the external detectors at inputs Y and X.</p> <p>Access Keys: MEAS 1 or MEAS 2, More Detection Options Broadband External</p>
YYYY-MM-DD HH:MM	<p>Softkey in the clock format menu. Formats the real-time internal clock to display time as Year-Month-Day Hour:Minute (YYYY-MM-DD HH:MM).</p> <p>Access Keys: SYSTEM OPTIONS System Config Set Clock Clock Format</p>

Z

Z0	<p>Softkey in the open, short, load, and through menus. Allows you to modify the Z_0 characteristic of the open, short, load, or through calibration standards in your calibration kit.</p> <p>See “Calibration Kits” on page 6-23 for more information.</p> <p>Access Keys: CAL More Cal Cal Kit Modify (connector type) , Open or Short or Load or Thru</p>
-----------	--

9 **Specifications**

Definitions

All specifications and characteristics apply over a $25\text{ }^{\circ}\text{C} \pm 5\text{ }^{\circ}\text{C}$ range (unless otherwise stated) and sixty minutes after the instrument has been turned on.

Specification (spec.): Warranted performance. Specifications include guardbands to account for the expected statistical distribution, measurement uncertainties, and changes in performance due to environmental conditions.

Characteristic (char.): A performance parameter that the product is expected to meet before it leaves the factory, but is not verified in the field and is not covered by the product warranty. A characteristic includes the same guardbands as a specification.

Typical (typ.): Expected performance of an average unit which does not include guardbands. It is not covered by the product warranty.

Nominal (nom.): A general descriptive term that does not imply a level of performance. It is not covered by the product warranty.

Calibration: The process of measuring known standards from a calibration kit to characterize the systematic (repeatable) errors of a network analyzer.

Corrected (residual) Performance: Indicates performance after error correction (calibration). It is determined by the quality of calibration standards and how well “known” they are, plus system repeatability, stability, and noise.

Uncorrected (raw) Performance: Indicates instrument performance without error correction. The uncorrected performance affects the stability of a calibration.

System Performance

Table 9-1 System Performance, Corrected, 50Ω, 2-Port Calibration

8712ES/8714ES (50 Ω) 85031B (7-mm, 50 Ω) Cal Kit, User 2-Port Calibration		
Description	Specification^a (in dB)	
	300 kHz to 1.3 GHz	1.3 GHz to 3 GHz
Directivity	55	51
Source Match	51	49
Load Match	55	51
Reflection Tracking	± 0.012	± 0.005
Transmission Tracking	± 0.033	± 0.035
Transmission Uncertainty (Specification)^{a,b}		
Magnitude		
Phase		
Reflection Uncertainty (Specification)^a		
Magnitude		
Phase		

- These specifications apply for measurements made using "fine" bandwidth, no averaging, and at an environmental temperature of $25^\circ \pm 5^\circ \text{C}$, with less than 1°C deviation from the calibration temperature.
- For transmission measurements, the effect of crosstalk is disregarded and $S_{12} = S_{21}$ for $S_{21} < 1.0$, $S_{12} = 1/S_{21}$ for $S_{21} > 1.0$.

Table 9-1 System Performance, Corrected, 50Ω, 2-Port Calibration (continued)

8712ES/8714ES (50 Ω) 85032B/E (Type-N, 50 Ω) Cal Kit, User 2-Port Calibration		
Description	Specification^a (in dB)	
	300 kHz to 1.3 GHz	1.3 GHz to 3 GHz
Directivity	50	47
Source Match	42	36
Load Match	50	47
Reflection Tracking	±0.02	±0.02
Transmission Tracking	±0.04	±0.055
Transmission Uncertainty (Specification)^{a,b}		
Magnitude		
Phase		
Reflection Uncertainty (Specification)^a		
Magnitude		
Phase		

- a. These specifications apply for measurements made using "fine" bandwidth, no averaging, and at an environmental temperature of 25° ± 5° C, with less than 1° C deviation from the calibration temperature.
- b. For transmission measurements, the effect of crosstalk is disregarded and $S_{12} = S_{21}$ for $S_{21} < 1.0$, $S_{12} = 1/S_{21}$ for $S_{21} > 1.0$.

Table 9-1 System Performance, Corrected, 50Ω, 2-Port Calibration (continued)

8712ES/8714ES (50 Ω) 85033D (3.5 mm, 50 Ω) Cal Kit, User 2-Port Calibration		
Description	Specification ^a (in dB)	
	300 kHz to 1.3 GHz	1.3 GHz to 3 GHz
Directivity	46	43
Source Match	44	41
Load Match	46	43
Reflection Tracking	±0.016	±0.008
Transmission Tracking	±0.04	±0.05
Transmission Uncertainty (Specification) ^{a,b}		
Magnitude 	Phase 	
Reflection Uncertainty (Specification) ^a		
Magnitude 	Phase 	

- These specifications apply for measurements made using “fine” bandwidth, no averaging, and at an environmental temperature of 25° ± 5° C, with less than 1° C deviation from the calibration temperature.
- For transmission measurements, the effect of crosstalk is disregarded and $S_{12} = S_{21}$ for $S_{21} < 1.0$, $S_{12} = 1 / S_{21}$ for $S_{21} > 1.0$.

Table 9-1 System Performance, Corrected, 50Ω, 2-Port Calibration (continued)

8712ES/8714ES (50 Ω) 85038A (7-16, 50 Ω) Cal Kit, User 2-Port Calibration		
Description	Specification^a (in dB)	
	300 kHz to 1.3 GHz	1.3 GHz to 3 GHz
Directivity	40	40
Source Match	37	37
Load Match	40	40
Reflection Tracking	±0.1	±0.09
Transmission Tracking	±0.054	±0.063
Transmission Uncertainty (Specification)^{a,b}		
Magnitude		
Phase		
Reflection Uncertainty (Specification)^a		
Magnitude		
Phase		

- a. These specifications apply for measurements made using “fine” bandwidth, no averaging, and at an environmental temperature of 25° ± 5° C, with less than 1° C deviation from the calibration temperature.
- b. For transmission measurements, the effect of crosstalk is disregarded and $S_{12} = S_{21}$ for $S_{21} < 1.0$, $S_{12} = 1 / S_{21}$ for $S_{21} > 1.0$.

Table 9-2 System Performance, Corrected, 75Ω, 2-Port Calibration

8712ES/8714ES (75 Ω) 85036B/E (Type-N, 75 Ω) Cal Kit, User 2-Port Calibration		
Description	Specification ^a (in dB)	
	300 kHz to 1.3 GHz	1.3 GHz to 3 GHz
Directivity	48	43
Source Match	41	35
Load Match	48	43
Reflection Tracking	±0.021	±0.02
Transmission Tracking	±0.042	±0.062
Transmission Uncertainty (Specification) ^{a,b}		
Magnitude 	Phase 	
Reflection Uncertainty (Specification) ^a		
Magnitude 	Phase 	

- a. These specifications apply for measurements made using “fine” bandwidth, no averaging, and at an environmental temperature of 25° ± 5° C, with less than 1° C deviation from the calibration temperature.
- b. For transmission measurements, the effect of crosstalk is disregarded and $S_{12} = S_{21}$ for $S_{21} < 1.0$, $S_{12} = 1 / S_{21}$ for $S_{21} > 1.0$.

Table 9-2 System Performance, Corrected, 75Ω, 2-Port Calibration (continued)

8712ES/8714ES (75 Ω) 85039B (Type-F, 75 Ω) Cal Kit, User 2-Port Calibration		
Description	Specification ^a (in dB)	
	300 kHz to 1.0 GHz	1.0 GHz to 3 GHz
Directivity	40	40
Source Match	30	30
Load Match	40	40
Reflection Tracking ^b	±0.071	±0.025
Transmission Tracking ^b	±0.073	±0.090
Transmission Uncertainty (Specification) ^{a,c}		
Magnitude 	Phase 	
Reflection Uncertainty (Specification) ^a		
Magnitude 	Phase 	

- a. These specifications apply for measurements made using “fine” bandwidth, no averaging, and at an environmental temperature of 25° ± 5° C, with less than 1° C deviation from the calibration temperature.
- b. Assumes using an 85039B cal kit, and a DUT with a center pin conforming to the 0.77 to 0.86 mm limits.
- c. For transmission measurements, the effect of crosstalk is disregarded and $S_{12} = S_{21}$ for $S_{21} < 1.0$, $S_{12} = 1 / S_{21}$ for $S_{21} > 1.0$.

Specifications

Table 9-3 System Performance, Corrected, 50Ω, T/R Calibration

8712ES/8714ES (50 Ω) 85032B/E (Type-N, 50 Ω) Cal Kit, T/R Calibration		
Description	Specification^a (in dB)	
	300 kHz to 1.3 GHz	1.3 GHz to 3 GHz
Directivity	50	47
Source Match:		
Reflection (One-Port Cal)	42	36
Transmission (Enhanced Response Cal)	42	36
Transmission (Response Cal)	18	15
Load Match	18	15
Reflection Tracking	±0.02	±0.02
Transmission Tracking:		
Enhanced Response Cal	±0.040	±0.055
Response Cal	±0.17	±0.3

- a. These specifications apply for measurements made using "fine" bandwidth, no averaging, and at an environmental temperature of $25^{\circ} \pm 5^{\circ} \text{C}$, with less than 1°C deviation from the calibration temperature.

Table 9-3 System Performance, Corrected, 50Ω, T/R Calibration (continued)

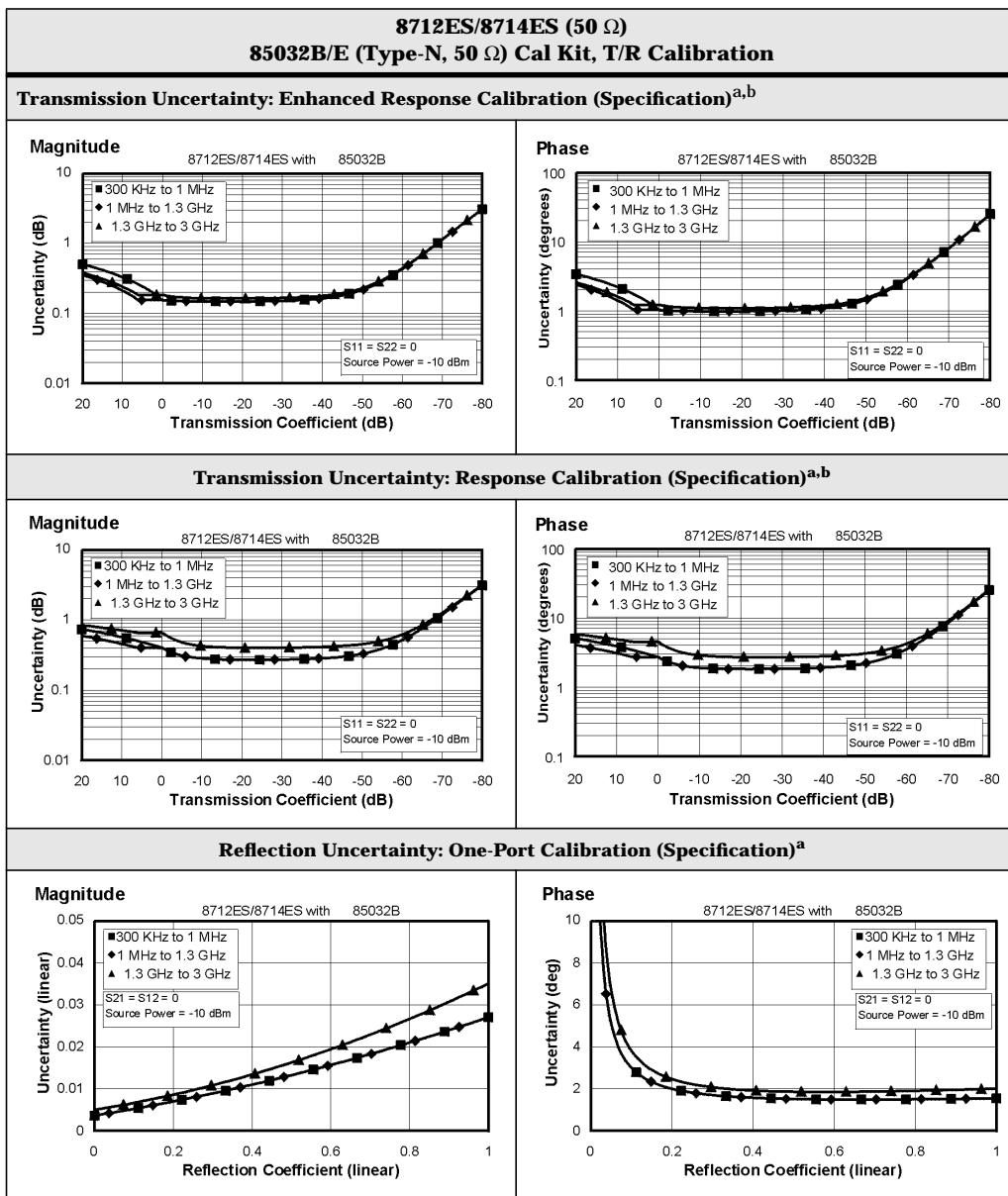

- a. These specifications apply for measurements made using "fine" bandwidth, no averaging, and at an environmental temperature of $25^{\circ} \pm 5^{\circ} \text{C}$, with less than 1°C deviation from the calibration temperature.
- b. For transmission measurements, the effect of crosstalk is disregarded and $S_{12} = S_{21}$ for $S_{21} < 1.0$, $S_{12} = 1/S_{21}$ for $S_{21} > 1.0$.

Specifications

Table 9-3 System Performance, Corrected, 50Ω, T/R Calibration (continued)

8712ET/8714ET (50 Ω) with Attenuator Option 1E1^a 85032B/E (Type-N, 50 Ω) Cal Kit, T/R Calibration		
Description	Specification^b (in dB)	
	300 kHz to 1.3 GHz	1.3 GHz to 3 GHz
Directivity	50	47
Source Match:		
Reflection (One-Port Cal)	42	36
Transmission (Enhanced Response Cal)	42	36
Transmission (Response Cal)	21	15
Load Match	18	15
Reflection Tracking	±0.02	±0.02
Transmission Tracking:		
Enhanced Response Cal	±0.039	±0.055
Response Cal	±0.13	±0.3

- a. Option 1E1 adds a 60 dB step attenuator to the 8712ET/8714ET.
- b. These specifications apply for measurements made using “fine” bandwidth, no averaging, and at an environmental temperature of $25^{\circ} \pm 5^{\circ}$ C, with less than 1° C deviation from the calibration temperature.

Table 9-3 System Performance, Corrected, 50Ω, T/R Calibration (continued)

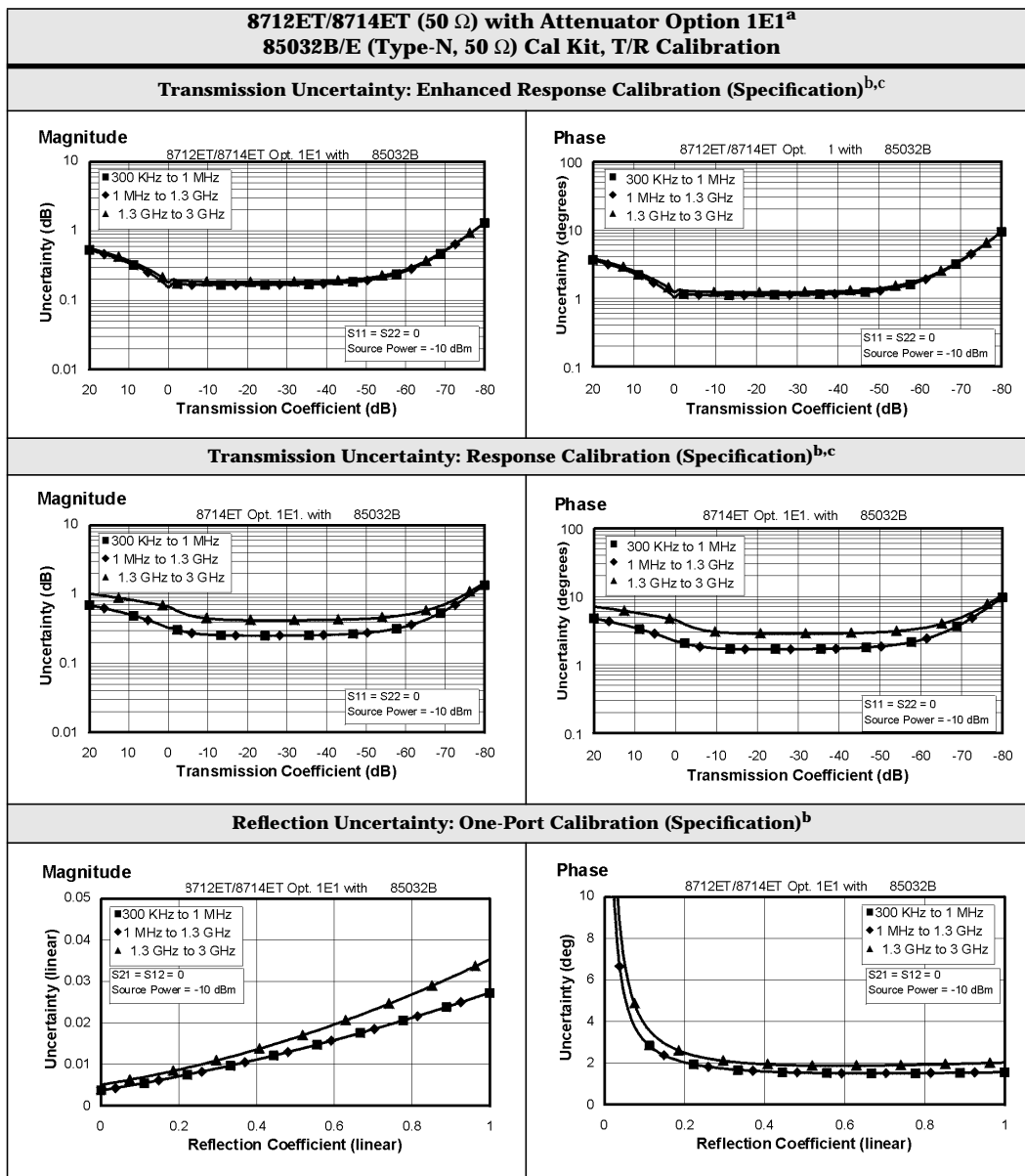

- a. Option 1E1 adds a 60 dB step attenuator to the 8712ET/8714ET.
- b. These specifications apply for measurements made using "fine" bandwidth, no averaging, and at an environmental temperature of 25° ± 5° C, with less than 1° C deviation from the calibration temperature.
- c. For transmission measurements, the effect of crosstalk is disregarded and $S_{12} = S_{21}$ for $S_{21} < 1.0$, $S_{12} = 1 / S_{21}$ for $S_{21} > 1.0$.

Specifications

Table 9-3 System Performance, Corrected, 50Ω, T/R Calibration (continued)

8712ET/8714ET (50 Ω) without Attenuator 85032B/E (Type-N, 50 Ω) Cal Kit, T/R Calibration		
Description	Specification^a (in dB)	
	300 kHz to 1.3 GHz	1.3 GHz to 3 GHz
Directivity	50	47
Source Match:		
Reflection (One-Port Cal)	42	36
Transmission (Enhanced Response Cal)	42	36
Transmission (Response Cal)	23	19
Load Match	18	15
Reflection Tracking	±0.02	±0.02
Transmission Tracking:		
Enhanced Response Cal	±0.039	±0.052
Response Cal	±0.105	±0.197

- a. These specifications apply for measurements made using “fine” bandwidth, no averaging, and at an environmental temperature of $25^{\circ} \pm 5^{\circ}$ C, with less than 1° C deviation from the calibration temperature.

Table 9-3 System Performance, Corrected, 50Ω, T/R Calibration (continued)

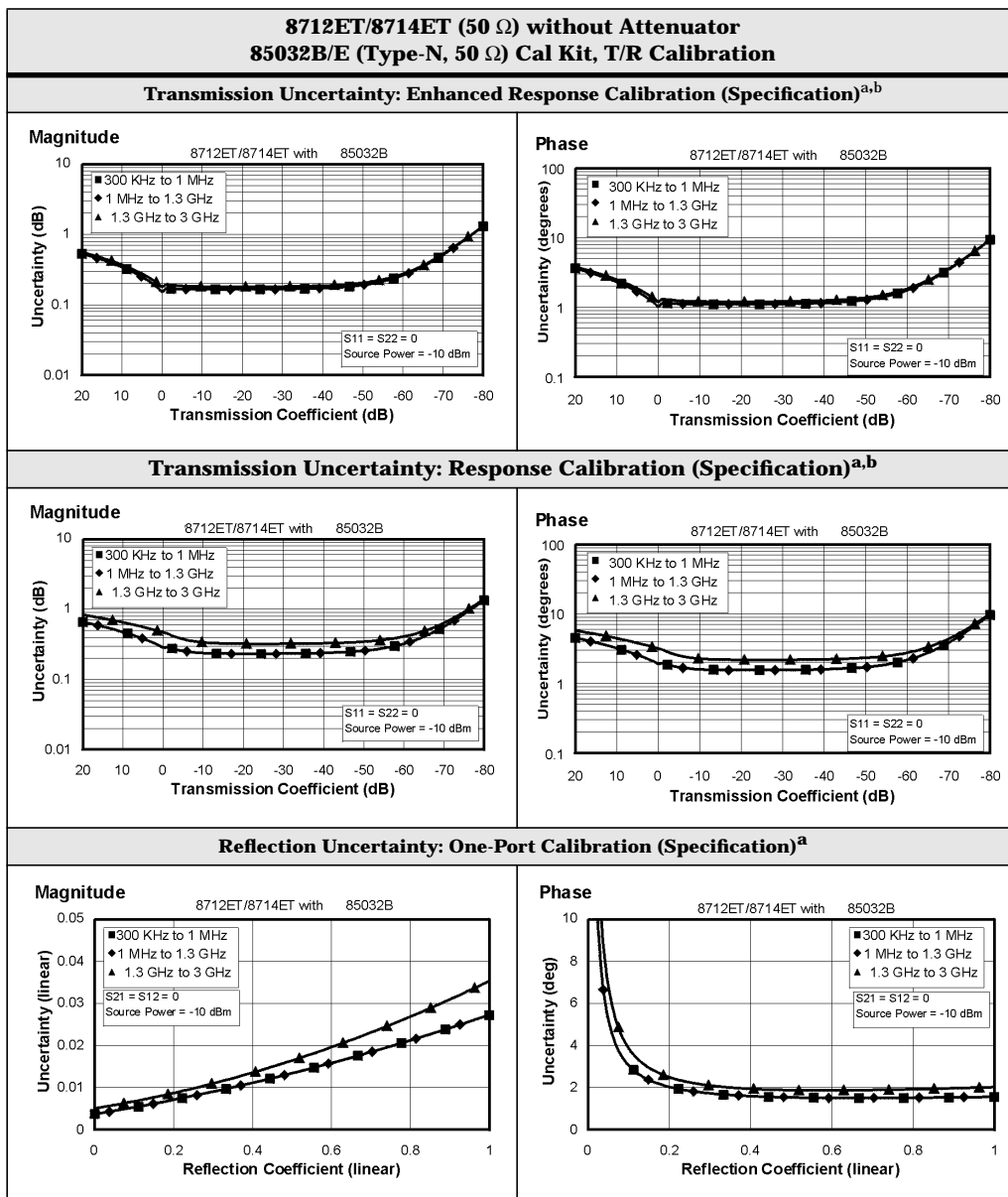

- a. These specifications apply for measurements made using "fine" bandwidth, no averaging, and at an environmental temperature of $25^{\circ} \pm 5^{\circ} \text{C}$, with less than 1°C deviation from the calibration temperature.
- b. For transmission measurements, the effect of crosstalk is disregarded and $S_{12} = S_{21}$ for $S_{21} < 1.0$, $S_{12} = 1/S_{21}$ for $S_{21} > 1.0$.

Specifications

Table 9-4 System Performance, Corrected, 75Ω, T/R Calibration

8712ES/8714ES (75 Ω) 85036B/E (Type-N, 75 Ω) Cal Kit, T/R Calibration		
Description	Specification^a (in dB)	
	300 kHz to 1.3 GHz	1.3 GHz to 3 GHz
Directivity	48	43
Source Match:		
Reflection (One-Port Cal)	41	35
Transmission (Enhanced Response Cal)	41	35
Transmission (Response Cal)	18	15
Load Match	18	15
Reflection Tracking	±0.021	±0.02
Transmission Tracking:		
Enhanced Response Cal	±0.042	±0.062
Response Cal	±0.17	±0.3

- a. These specifications apply for measurements made using "fine" bandwidth, no averaging, and at an environmental temperature of $25^{\circ} \pm 5^{\circ}$ C, with less than 1° C deviation from the calibration temperature.

Table 9-4 System Performance, Corrected, 75Ω, T/R Calibration (continued)

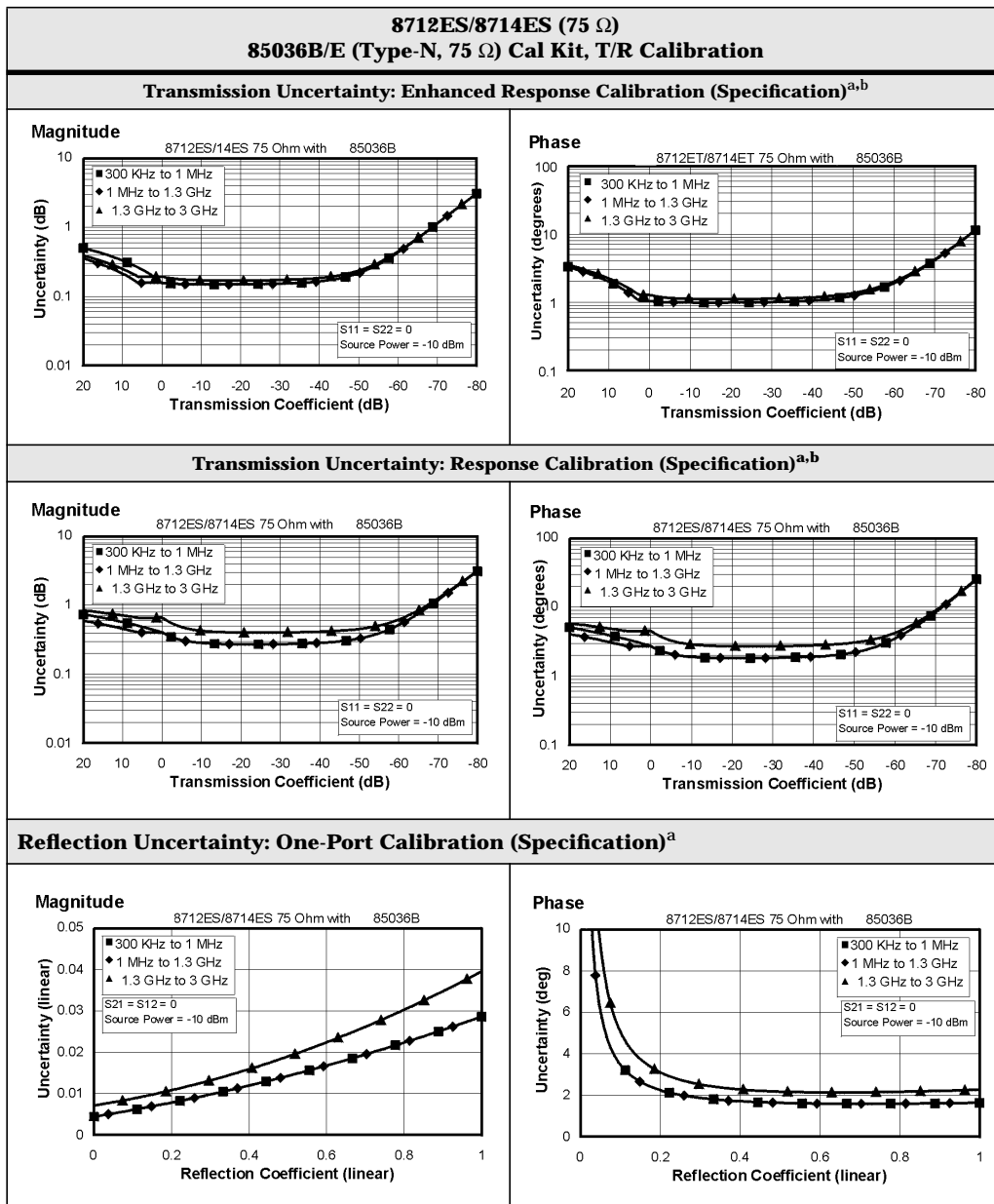

- a. These specifications apply for measurements made using “fine” bandwidth, no averaging, and at an environmental temperature of $25^{\circ} \pm 5^{\circ} \text{C}$, with less than 1°C deviation from the calibration temperature.
- b. For transmission measurements, the effect of crosstalk is disregarded and $S_{12} = S_{21}$ for $S_{21} < 1.0$, $S_{12} = 1/S_{21}$ for $S_{21} > 1.0$.

Specifications

Table 9-4 System Performance, Corrected, 75Ω, T/R Calibration (continued)

8712ET/8714ET (75 Ω) with Attenuator Option 1E1^a 85036B/E (Type-N, 75 Ω) Cal Kit, T/R Calibration		
Description	Specification^b (in dB)	
	300 kHz to 1.3 GHz	1.3 GHz to 3 GHz
Directivity	48	43
Source Match:		
Reflection (One-Port Cal)	41	35
Transmission (Enhanced Response Cal)	41	35
Transmission (Response Cal)	21	15
Load Match	18	15
Reflection Tracking	±0.021	±0.02
Transmission Tracking:		
Enhanced Response Cal	±0.04	±0.062
Response Cal	±0.125	±0.295

- a. Option 1E1 adds a 60 dB step attenuator to the 8712ET/8714ET.
- b. These specifications apply for measurements made using “fine” bandwidth, no averaging, and at an environmental temperature of $25^{\circ} \pm 5^{\circ}$ C, with less than 1° C deviation from the calibration temperature.

Table 9-4 System Performance, Corrected, 75Ω, T/R Calibration (continued)

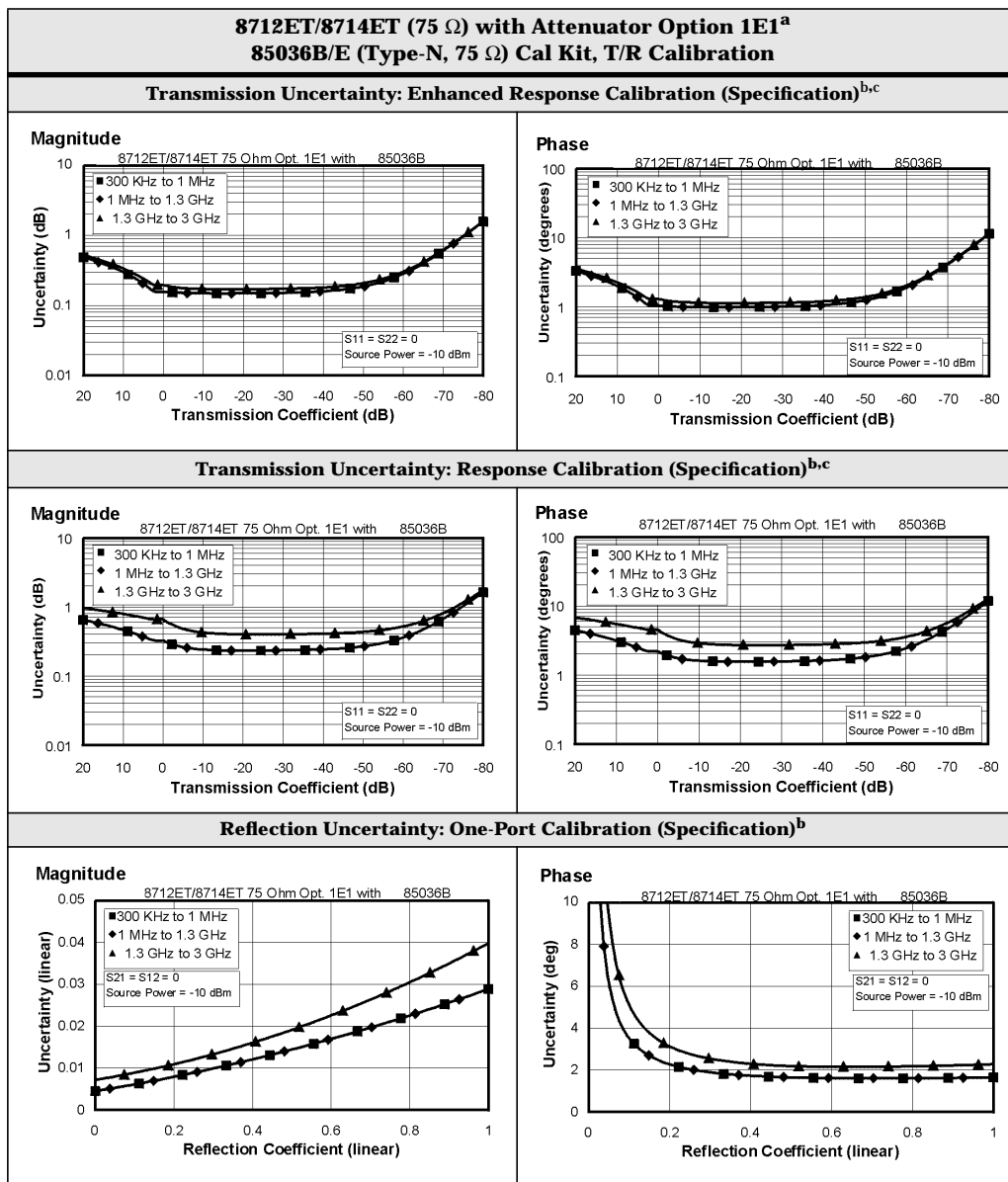

- a. Option 1E1 adds a 60 dB step attenuator to the 8712ET/8714ET.
- b. These specifications apply for measurements made using "fine" bandwidth, no averaging, and at an environmental temperature of $25^\circ \pm 5^\circ \text{C}$, with less than 1°C deviation from the calibration temperature.
- c. For transmission measurements, the effect of crosstalk is disregarded and $S_{12} = S_{21}$ for $S_{21} < 1.0$, $S_{12} = 1 / S_{21}$ for $S_{21} > 1.0$.

Specifications

Table 9-4 System Performance, Corrected, 75Ω, T/R Calibration (continued)

8712ET/8714ET (75 Ω) without Attenuator 85036B/E (Type-N, 75 Ω) Cal Kit, T/R Calibration		
Description	Specification^a (in dB)	
	300 kHz to 1.3 GHz	1.3 GHz to 3 GHz
Directivity	48	43
Source Match:		
Reflection (One-Port Cal)	41	35
Transmission (Enhanced Response Cal)	41	35
Transmission (Response Cal)	23	19
Load Match	18	15
Reflection Tracking	±0.021	±0.02
Transmission Tracking:		
Enhanced Response Cal	±0.04	±0.058
Response Cal	±0.11	±0.2

- a. These specifications apply for measurements made using “fine” bandwidth, no averaging, and at an environmental temperature of $25^{\circ} \pm 5^{\circ} \text{C}$, with less than 1°C deviation from the calibration temperature.

Table 9-4 System Performance, Corrected, 75Ω, T/R Calibration (continued)

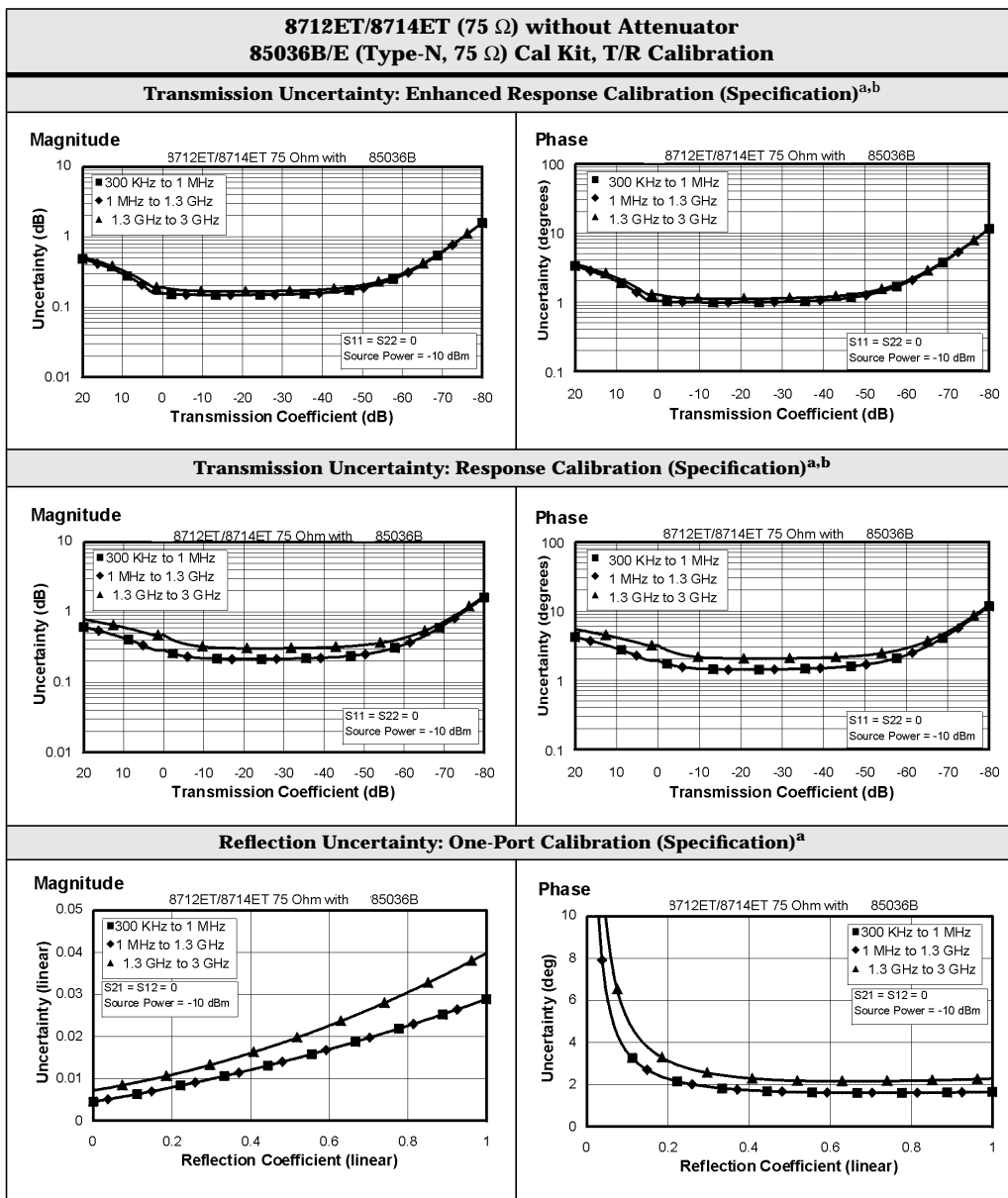

- a. These specifications apply for measurements made using "fine" bandwidth, no averaging, and at an environmental temperature of $25^{\circ} \pm 5^{\circ} \text{C}$, with less than 1°C deviation from the calibration temperature.
- b. For transmission measurements, the effect of crosstalk is disregarded and $S_{12} = S_{21}$ for $S_{21} < 1.0$, $S_{12} = 1/S_{21}$ for $S_{21} > 1.0$.

Table 9-5 System Performance, Uncorrected, 50Ω

8712ET/ES and 8714ET/ES (50 Ω)						
Description	8712ES/8714ES		8712ET/8714ET with Attenuator Option 1E1 ^a		8712ET/8714ET (without Attenuator)	
	300 kHz to 1.3 GHz	1.3 GHz to 3 GHz	300 kHz to 1.3 GHz	1.3 GHz to 3 GHz	300 kHz to 1.3 GHz	1.3 GHz to 3 GHz
Specification^b (in dB)						
Directivity ^c	29	23	29	21	29	23
Source Match (Ratio) ^d	18	15	21	15	23	19
Load Match ^e	18	15	18	15	18	15
Crosstalk ^f	88	88	97	97	97	97
Typical^b (in dB)						
Directivity	40	35	42	32	42	32
Source Match (Ratio)	23	20	26	21	30	23
Load Match	24	21	24	22	24	22
Reflection Tracking	±2.0	±2.0	±1.0	±1.5	±1.0	±1.0
Transmission Tracking	±2.0	±2.0	±1.5	±1.5	±1.5	±1.5
Crosstalk ^f	95	95	105	105	105	105

- a. Option 1E1 adds a 60 dB step attenuator to the 8712ET/8714ET.
- b. These numbers apply for a measurement made using the “Fine” bandwidth at an environmental temperature of 25° ± 5° C.
- c. The uncorrected directivity of a network analyzer is calculated in linear terms by dividing the reflection measurement of an ideal load by the average of the reflection measurements of an ideal short and an ideal open.
- d. The uncorrected source match is the source match of the network analyzer when making a ratioed, uncalibrated measurement.
- e. The uncorrected load match is the match of the network analyzer port used on the load side of a measurement.
- f. Measured by setting output power to the maximum specified setting, connecting shorts to both ports, and measuring transmission. Typical and specified crosstalk values are 5 dB worse than those shown in the table below 1 MHz (for all models) and above 2.2 GHz (for 8714ET/ES models).

Table 9-6 System Performance, Uncorrected, 75Ω

8712ET/ES and 8714ET/ES (75 Ω)						
Description	8712ES/8714ES		8712ET/8714ET with Attenuator Option 1E1 ^a		8712ET/8714ET (without Attenuator)	
	300 kHz to 1.3 GHz	1.3 GHz to 3 GHz	300 kHz to 1.3 GHz	1.3 GHz to 3 GHz	300 kHz to 1.3 GHz	1.3 GHz to 3 GHz
Specification^b (in dB)						
Directivity ^c	27	19	27	19	27	18
Source Match (Ratio) ^d	18	15	21	15	23	19
Load Match ^e	18	15	18	15	18	15
Crosstalk ^f	88	88	97	97	97	97
Typical^b (in dB)						
Directivity	40	30	40	30	40	30
Source Match (Ratio)	23	20	24	20	28	23
Load Match	24	22	24	22	24	22
Reflection Tracking	±1.5	±1.5	±1.0	±1.5	±1.0	±1.0
Transmission Tracking	±1.5	±1.5	±1.5	±1.5	±1.0	±1.0
Crosstalk ^f	95	95	105	105	105	105

a. Option 1E1 adds a 60 dB step attenuator to the 8712ET/8714ET.

b. These numbers apply for a measurement made using the “Fine” bandwidth at an environmental temperature of $25^{\circ} \pm 5^{\circ} \text{C}$.

c. The uncorrected directivity of a network analyzer is calculated in linear terms by dividing the reflection measurement of a perfect load by the average of the reflection measurements of an ideal short and an ideal open.

d. The uncorrected source match is the source match of the network analyzer when making a ratioed, uncalibrated measurement.

e. The uncorrected load match is the match of the network analyzer port used on the load side of a measurement.

f. Measured by setting output power to the maximum specified setting, connecting shorts to both ports, and measuring transmission. Typical and specified crosstalk values are 5 dB worse than those shown in the table below 1 MHz (for all models) and above 2.2 GHz (for 8714ET/ES models).

Test Port Output

Table 9-7 Test Port Output

8712ET/ES and 8714ET/ES Test Port Output		
Description	Specification	Supplemental Information
Frequency		
Range:		
8712ET/ES	300 kHz to 1.3 GHz	
8714ET/ES	300 kHz to 3.0 GHz	
Resolution	1 Hz	
Stability		±5 ppm, 0° to 55° C, typ.
CW Accuracy	±5 ppm at 25° ±5° C	<1Hz at 10% change in line voltage, typ.
Signal Purity		
Harmonics:		
8712ET/ES	<-20 dBc at <1 MHz <-30 dBc at >1 MHz	
8714ET/ES	<-30 dBc	
Nonharmonic Spurious:		
8712ET/ES, <50 kHz from carrier		<-25 dBc, char.
8712ET/ES, >50 kHz from carrier		<-20 dBc at <1MHz, char. <-30 dBc at >1MHz, char.
8714ET/ES, <50 kHz from carrier		<-25 dBc, char.
8714ET/ES, >50 kHz from carrier		<-30 dBc, char.
Phase Noise (at 10 kHz offset):		
8712ET/ES		<-67 dBc/Hz, char.
8714ET/ES		<-67 dBc/Hz, char.
Residual AM (in 100 kHz bandwidth)		<-50 dBc, nom.
Residual FM (30 Hz to 15 kHz)		<1.5 kHz peak, nom.

Table 9-7 Test Port Output (continued)

8712ET/ES and 8714ET/ES Test Port Output		
Description	Specification	Supplemental Information
Output Power		
Level Accuracy:		
8712ET:		
50 Ω :		
With Attenuator Option 1E1 ^a	± 2.0 dB	
Without Attenuator Option 1E1	± 1.0 dB	
75 Ω :		
With Attenuator Option 1E1 ^a	± 3.0 dB	
Without Attenuator Option 1E1	± 1.5 dB	
8712ES:		
50 Ω	± 2.0 dB	
75 Ω	± 3.0 dB	
8714ET:		
50 Ω :		
With Attenuator Option 1E1 ^a	± 2.0 dB	
Without Attenuator Option 1E1	± 1.0 dB	
75 Ω :		
With Attenuator Option 1E1 ^a	± 3.0 dB at <2 GHz	± 3.0 dB at >2 GHz, char.
Without Attenuator Option 1E1	± 1.5 dB at <2 GHz	± 1.5 dB at >2 GHz, char.
8714ES:		
50 Ω	± 2.0 dB	
75 Ω	± 3.0 dB at <2 GHz	± 3.0 dB at >2 GHz, char.

a. Option 1E1 adds a 60 dB step attenuator to the 8712ET/8714ET.

Table 9-7 Test Port Output (continued)

8712ET/ES and 8714ET/ES Test Port Output		
Description	Specification	Supplemental Information
Output Power (continued)		
Minimum Power Setting:		
8712ET:		
50 Ω:		
With Attenuator Option 1E1 ^a		-60 dBm, nom.
Without Attenuator Option 1E1		0 dBm, nom.
75 Ω:		
With Attenuator Option 1E1 ^a		-60 dBm, nom.
Without Attenuator Option 1E1		-3 dBm, nom.
8712ES:		
50 Ω		-60 dBm, nom.
75 Ω		-60 dBm, nom.
8714ET:		
50 Ω:		
With Attenuator Option 1E1 ^a		-60 dBm, nom.
Without Attenuator Option 1E1		-5 dBm, nom.
75 Ω:		
With Attenuator Option 1E1 ^a		-60 dBm, nom.
Without Attenuator Option 1E1		-8 dBm, nom.
8714ES:		
50 Ω		-60 dBm, nom.
75 Ω		-60 dBm, nom.

a. Option 1E1 adds a 60 dB step attenuator to the 8712ET/8714ET.

Table 9-7 Test Port Output (continued)

8712ET/ES and 8714ET/ES Test Port Output			
Description	Specification		Supplemental Information
Output Power (continued)			
	<1 GHz	>1 GHz	
Maximum Power Setting: ^a			
8712ET:			
50 Ω:			
With Attenuator Option 1E1 ^b	15 dBm	12 dBm	
Without Attenuator Option 1E1	16 dBm	13 dBm	
75 Ω:			
With Attenuator Option 1E1 ^b	12 dBm	9 dBm	
Without Attenuator Option 1E1	13 dBm	10 dBm	
8712ES:			
50 Ω	13 dBm	10 dBm	
75 Ω	10 dBm	7 dBm	
8714ET:			
50 Ω:			
With Attenuator Option 1E1 ^b	10 dBm	9 dBm	
Without Attenuator Option 1E1	11 dBm	10 dBm	
75 Ω:			
With Attenuator Option 1E1 ^b	7 dBm	6 dBm at <2 GHz	6 dBm at >2 GHz, char.
Without Attenuator Option 1E1	8 dBm	7 dBm at <2 GHz	7 dBm at >2 GHz, char.
8714ES:			
50 Ω	9 dBm	7 dBm	
75 Ω	6 dBm	4 dBm at <2 GHz	4 dBm at >2 GHz, char.

a. Maximum power setting is the highest power setting allowed that maintains the network analyzer's specified level accuracy.

b. Option 1E1 adds a 60 dB step attenuator to the 8712ET/8714ET.

Table 9-7 Test Port Output (continued)

8712ET/ES and 8714ET/ES Test Port Output							
Description	Nominal (in dBm)						
	Attn = 0 dB	Attn = 10 dB	Attn = 20 dB	Attn = 30 dB	Attn = 40 dB	Attn = 50 dB	Attn = 60 dB
Power Sweep Ranges:							
8712ET:							
50 Ω:							
With Attenuator Option 1E1 ^a	-1 to P _{max} ^b	-11 to 2	-21 to -8	-31 to -18	-41 to -28	-51 to -38	-60 to -48
Without Attenuator Option 1E1	0 to P _{max} ^b						
75 Ω:							
With Attenuator Option 1E1 ^a	-4 to P _{max} ^b	-14 to -1	-24 to -11	-34 to -21	-44 to -31	-54 to -41	-60 to -51
Without Attenuator Option 1E1	-3 to P _{max} ^b						
8712ES:							
50 Ω	-3 to P _{max} ^b	-13 to 0	-23 to -10	-33 to -20	-43 to -30	-53 to -40	-60 to -50
75 Ω	-6 to P _{max} ^b	-16 to -3	-26 to -13	-36 to -23	-46 to -33	-56 to -43	-60 to -53
8714ET:							
50 Ω:							
With Attenuator Option 1E1 ^a	-6 to P _{max} ^b	-16 to -1	-26 to -11	-36 to -21	-46 to -31	-56 to -41	-60 to -51
Without Attenuator Option 1E1	-5 to P _{max} ^b						
75 Ω:							
With Attenuator Option 1E1 ^a	-9 to P _{max} ^b	-19 to -4	-29 to -14	-39 to -24	-49 to -34	-59 to -44	-60 to -54
Without Attenuator Option 1E1	-8 to P _{max} ^b						
8714ES:							
50 Ω	-8 to P _{max} ^b	-18 to -3	-28 to -13	-38 to -23	-48 to -33	-58 to -43	-60 to -53
75 Ω	-11 to P _{max} ^b	-21 to -6	-31 to -16	-41 to -26	-51 to -36	-60 to -46	-60 to -56

- a. Option 1E1 adds a 60 dB step attenuator to the 8712ET/8714ET.
- b. P_{max} = maximum power setting

Table 9-7 Test Port Output (continued)

8712ET/ES and 8714ET/ES Test Port Output		
Description	Specification	Supplemental Information
Output Power (continued)		
Power Resolution	0.01 dB	
Attenuator Switch Points:		
8712ET:		
50 Ω		-1, -11, -21, -31, -41, -51 dBm, nom.
75 Ω		-4, -14, -24, -34, -44, -54 dBm, nom.
8712ES:		
50 Ω		-3, -13, -23, -33, -43, -53 dBm, nom.
75 Ω		-6, -16, -26, -36, -46, -56 dBm, nom.
8714ET:		
50 Ω		-6, -16, -26, -36, -46, -56 dBm, nom.
75 Ω		-9, -19, -29, -39, -49, -59 dBm, nom.
8714ES:		
50 Ω		-8, -18, -28, -38, -48, -58 dBm, nom.
75 Ω		-11, -21, -31, -41, -51 dBm, nom.

Test Port Input

Table 9-8 Test Port Input

8712ET/ES and 8714ET/ES Test Port Input		
Description	Specification	Supplemental Information
Frequency Range		
8712ET/ES:		
Narrowband	300 kHz to 1.3 GHz	
Broadband	10 MHz to 1.3 GHz	
8714ET/ES:		
Narrowband	300 kHz to 3.0 GHz	
Broadband	10 MHz to 3.0 GHz	
Maximum Input Level		
8712ET/8714ET	+10 dBm at 0.5 dB compression	
8712ES and 8714ES:		
Narrowband, Frequency >1 MHz	+10 dBm at 0.3 dB compression	
Narrowband, Frequency <1 MHz	+10 dBm at 0.5 dB compression	
Broadband		+16 dBm at 0.55 dB compression
Damage Level		
8712ET/8714ET	+20 dBm; ± 30 VDC	
8712ES/8714ES	+26 dBm; ± 30 VDC	
Broadband Flatness		
8712ET/ES and 8714ET/ES		± 1 dB, characteristic

Table 9-8 Test Port Input (continued)

8712ET/ES and 8714ET/ES Test Port Input				
Description	Spec. (in dBm)	Typical (in dBm)		
	System Bandwidths:			
	Fine (15 Hz)	Fine (15 Hz)	Med Wide (4000 Hz)	Wide (6500 Hz)
Noise Floor^a				
8712ET/8714ET:				
50 Ω:				
Narrowband	-105	-111	-86	-48
Broadband (Internal)	-50	-55	-48	-32
75 Ω:				
Narrowband	-104	-109	-84	-46
Broadband (Internal)	-47	-52	-45	-30
8712ES/8714ES:				
50 Ω:				
Narrowband	-96	-105	-80	-47
Broadband (Internal)	-38	-43	-36	-23
75 Ω:				
Narrowband	-95	-104	-80	-47
Broadband (Internal)	-35	-40	-33	-20

- a. Noise floor is defined as the RMS value of the trace (in linear format) for a transmission measurement in CW Frequency mode, with the RF connectors terminated in loads, output power set to 0 dBm, and no averaging. The noise floor specifications and typicals for narrowband detection measurements assume that an isolation calibration has been performed using an average factor of 16. For the 8712ES/8714ES, external broadband detectors will provide a lower noise floor than the internal broadband detectors.

Table 9-8 Test Port Input (continued)

8712ET/ES and 8714ET/ES Test Port Input				
Description	Spec. (in dB)	Typical (in dB)		
	System Bandwidths:			
	Fine (15 Hz)	Fine (15 Hz)	Med Wide (4000 Hz)	Wide (6500 Hz)
System Dynamic Range^a				
8712ET:				
50 Ω:				
With Attenuator Option 1E1 ^b :				
Narrowband	115	121	96	58
Broadband (Internal)	60	67	60	44
Without Attenuator Option 1E1				
Narrowband	115	121	96	58
Broadband (Internal)	62	68	61	45
75 Ω:				
With Attenuator Option 1E1 ^b :				
Narrowband	110	118	93	55
Broadband (Internal)	53	61	54	39
Without Attenuator Option 1E1				
Narrowband	113	119	94	56
Broadband (Internal)	56	62	55	40

- a. The System Dynamic Range is calculated as the difference between the receiver noise floor and the minimum of either the source maximum output (maximum power setting minus output power level accuracy) or the receiver maximum input. System Dynamic Range applies to transmission measurements only, since reflection measurements are limited by directivity. The System Dynamic Range for 8714 ET/ES 75 Ω analyzers is not a specification for frequencies >2 GHz; it is a characteristic. For the 8712ES/8714ES, external broadband detectors will provide more dynamic range than the internal broadband detectors.
- b. Option 1E1 adds a 60 dB step attenuator to the 8712ET/8714ET.

Table 9-8 Test Port Input (continued)

8712ET/ES and 8714ET/ES Test Port Input				
Description	Spec. (in dB)	Typical (in dB)		
	System Bandwidths:			
	Fine (15 Hz)	Fine (15 Hz)	Med Wide (4000 Hz)	Wide (6500 Hz)
System Dynamic Range ^a (continued)				
8714ET:				
50 Ω:				
With Attenuator Option 1E1 ^b :				
Narrowband	112	120	95	57
Broadband (Internal)	57	64	57	41
Without Attenuator Option 1E1				
Narrowband	114	121	96	58
Broadband (Internal)	59	65	58	42
75 Ω:				
With Attenuator Option 1E1 ^b :				
Narrowband	107	115	90	52
Broadband (Internal)	50	58	51	36
Without Attenuator Option 1E1				
Narrowband	110	116	91	53
Broadband (Internal)	53	59	52	37

- a. The System Dynamic Range is calculated as the difference between the receiver noise floor and the minimum of either the source maximum output (maximum power setting minus output power level accuracy) or the receiver maximum input. System Dynamic Range applies to transmission measurements only, since reflection measurements are limited by directivity. The System Dynamic Range for 8714 ET/ES 75 W analyzers is not a specification for frequencies >2 GHz; it is a characteristic. For the 8712ES/8714ES, external broadband detectors will provide more dynamic range than the internal broadband detectors.
- b. Option 1E1 adds a 60 dB step attenuator to the 8712ET/8714ET.

Table 9-8 Test Port Input (continued)

8712ET/ES and 8714ET/ES Test Port Input				
Description	Spec. (in dB)	Typical (in dB)		
	System Bandwidths:			
	Fine (15 Hz)	Fine (15 Hz)	Med Wide (4000 Hz)	Wide (6500 Hz)
System Dynamic Range^a (continued)				
8712ES:				
50 Ω:				
Narrowband	104	115	90	57
Broadband (Internal)	46	53	46	33
75 Ω:				
Narrowband	99	111	87	54
Broadband (Internal)	39	47	40	27
8714ES:				
50 Ω:				
Narrowband	101	112	87	54
Broadband (Internal)	43	50	43	30
75 Ω:				
Narrowband	96	108	84	51
Broadband (Internal)	36	44	37	24

a. The System Dynamic Range is calculated as the difference between the receiver noise floor and the minimum of either the source maximum output (maximum power setting minus output power level accuracy) or the receiver maximum input. System Dynamic Range applies to transmission measurements only, since reflection measurements are limited by directivity. The System Dynamic Range for 8714 ET/ES 75 Ω analyzers is not a specification for frequencies >2 GHz; it is a characteristic. For the 8712ES/8714ES, external broadband detectors will provide more dynamic range than the internal broadband detectors.

Table 9-8 Test Port Input (continued)

8712ET/ES and 8714ET/ES Test Port Input				
Description	Spec. (in dB)	Typical (in dB)		
	System Bandwidths:			
	Fine (15 Hz)	Fine (15 Hz)	Med Wide (4000 Hz)	Wide (6500 Hz)
Receiver Dynamic Range^a				
8712ET/8714ET:				
50 Ω:				
Narrowband	115	121	96	58
Broadband (Internal)	66	71	64	48
75 Ω:				
Narrowband	114	119	94	56
Broadband (Internal)	63	68	61	46
8712ES/8714ES:				
50 Ω:				
Narrowband	106	115	90	57
Broadband (Internal)	54	59	52	39
75 Ω:				
Narrowband	105	114	90	57
Broadband (Internal)	51	56	49	36

- a. The Receiver Dynamic Range is calculated as the difference between the receiver noise floor and the receiver maximum input. Receiver Dynamic Range applies to transmission measurements only, since reflection measurements are limited by directivity. The Receiver Dynamic Range for 8714ET/ES 75 Ω analyzers is not a specification for frequencies >2 GHz; it is a characteristic. For the 8712ES/8714ES, external broadband detectors will provide more dynamic range than the internal broadband detectors.

Table 9-8 Test Port Input (continued)

8712ET/ES and 8714ET/ES Test Port Input				
Description	Spec.	Typical		
		System Bandwidths:		
	Narrow (250 Hz)	Narrow (250 Hz)	Med Wide (4000 Hz)	Wide (6500 Hz)
Trace Noise^a				
8712ET/8712ES:				
Narrowband:				
Magnitude	0.01 dB rms	0.03 dB-pp	0.12 dB-pp	0.28 dB-pp
Phase		0.2 Deg-pp	2.5 Deg-pp	3.4 Deg-pp
Broadband:				
Magnitude	0.01 dB rms	0.01 dB-pp	0.02 dB-pp	0.15 dB-pp
8714ET/8714ES:				
Narrowband:				
Magnitude	0.01 dB rms	0.02 dB-pp	0.06 dB-pp	0.23 dB-pp
Phase		0.2 Deg-pp	0.8 Deg-pp	1.8 Deg-pp
Broadband:				
Magnitude	0.01 dB rms	0.01 dB-pp	0.03 dB-pp	0.16 dB-pp

a. Trace noise is defined for a transmission measurement in CW mode, using a “through” cable having 0 dB loss, with the source set to 0 dBm, and the analyzer’s averaging function toggled off.

Table 9-8 Test Port Input (continued)

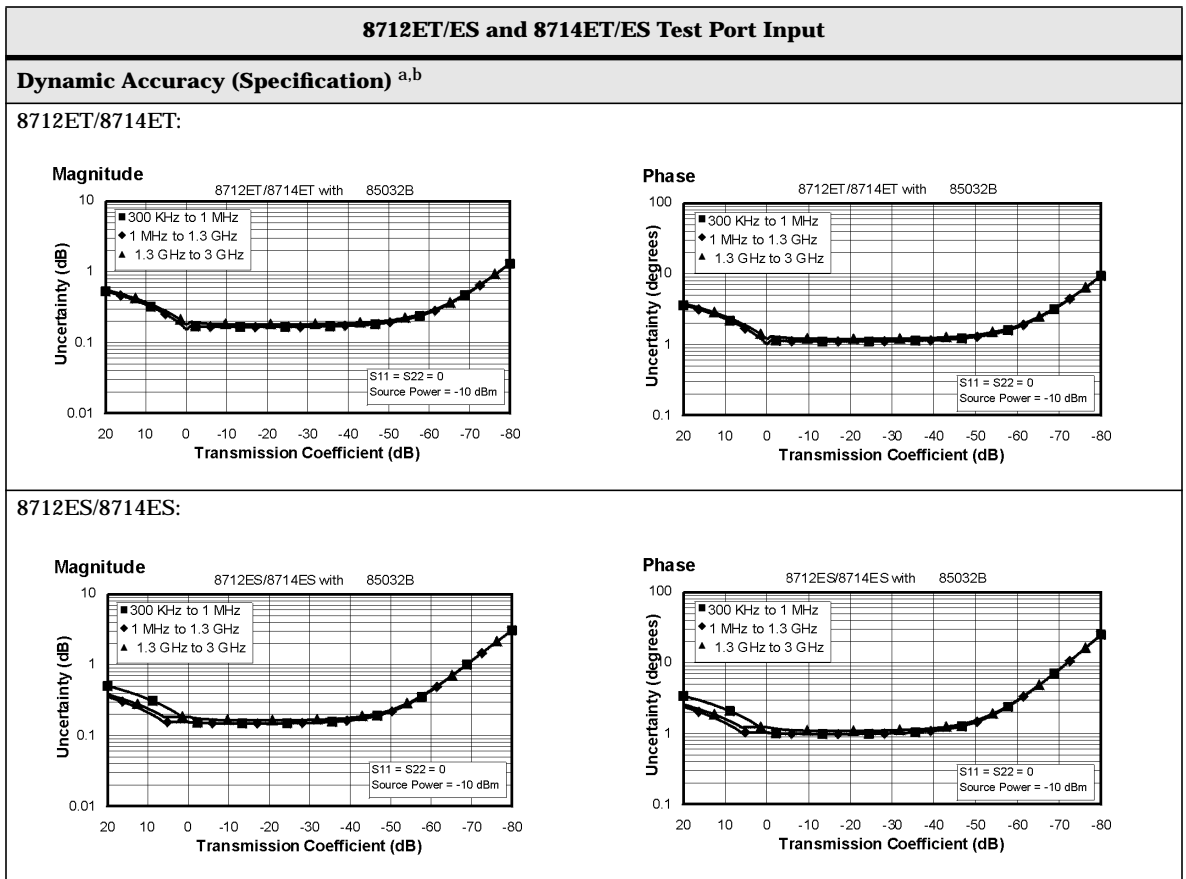

- a. Narrowband detection mode
- b. The reference power for dynamic accuracy is -20 dBm.

Table 9-8 Test Port Input (continued)

8712ET/ES and 8714ET/ES Test Port Input	
Power Accuracy: (Characteristic)	
8712ET/8714ET ^a :	
<p>Magnitude</p> <p style="text-align: left; margin-left: 100px;">pp6122ee</p>	
8712ES/8714ES ^a :	
<p>Magnitude</p> <p style="text-align: left; margin-left: 100px;">pp6123ee</p>	

a. At 30 MHz, broadband mode, internal detectors

Table 9-8 Test Port Input (continued)

8712ET/ES and 8714ET/ES Test Port Input
Group Delay Accuracy^a (Characteristic)
8712ET/ES and 8714ET/ES

- a. Valid for 85032B/E (type-N 50 Ω) and 85036B/E (type-N 75 Ω) cal kits using either a two-port or enhanced response calibration.

General Information

Table 9-9 General Information

8712ET/ES and 8714ET/ES General Information		
Description	Specification	Supplemental Information
Display Range		
Magnitude	200 dB (at 20 dB/div), max	
Phase	1800° (at 180°/div), max	
Polar	1 MUnit, max	
Display Resolution		
Magnitude	0.01 dB/div, min	
Phase	0.1°/div, min	
Polar	10 μUnit Full Scale, min	
Reference Level Range		
Magnitude	500 dB, max	
Phase	360°, max	
Reference Level Resolution		
Magnitude	0.01 dB, min	
Phase	0.01°, min	
Marker Resolution		
Magnitude	0.001 dB, min	
Phase	0.01°, min	
Polar	0.01 μUnit, min; 0.01°, min	
Group Delay Aperture		
Minimum	20% of frequency span	
Maximum	frequency span ÷ (# of points – 1)	
Group Delay Range		
	1 ÷ (2 x minimum aperture)	The maximum delay is limited to measuring no more than 180° of phase change within the minimum aperture.

Table 9-9 General Information (continued)

8712ET/ES and 8714ET/ES General Information		
Description	Specification	Supplemental Information
System Bandwidths		
Wide (6500 Hz)		6500 Hz, nom
Medium Wide (4000 Hz)		4000 Hz, nom
Medium (3700 Hz)		3700 Hz, nom
Medium Narrow (1200 Hz)		1200 Hz, nom
Narrow (250 Hz)		250 Hz, nom
Fine (15 Hz)		15 Hz, nom
Rear Panel		
Auxiliary Input: Connector Impedance Range Accuracy Damage Level	± 10 V $\pm 3\%$ (reading) + 20 mV >+15 V; <-15 V	Female BNC 10 k Ω , nom.
External Trigger In/Out: Damage Level	 <-0.2 V; >+5.2 V	Female BNC; Open-collector with 681 Ω nom. pullup resistor to +5 V, nom. Normally high, pulsed low after each data point is measured.
Limit Test Output: Damage Level	 <-0.2 V; >+5.2 V	Female BNC; Open-collector with 681 Ω nom. pullup resistor to +5 V, nom. Normally high, pulled low when limit test fails.
User TTL Input/Output: Damage Level	 <-0.2 V; >+5.2 V	Female BNC; Open-collector with 681 Ω nom. pullup resistor to +5 V nom. Programmable as: high-sweep output; trigger input; general I/O for IBASIC.

Table 9-9 General Information (continued)

8712ET/ES and 8714ET/ES General Information		
Description	Specification	Supplemental Information
Rear Panel (continued)		
External Reference In: Input Frequency Input Power Input Impedance		10 MHz, nom. -5 dBm to +12 dBm, nom. 50 Ω , nom.
VGA Video Output		15-pin mini D-Sub; female. Firmware supports normal and inverse video color formats.
GPIB		Type-57, 24-pin; Microribbon female
X and Y External Detector Inputs		12-pin circular; female
Parallel Port		25-pin D-Sub (DB-25); female
LAN		8-pin RJ45; female
RS232		9-pin D-Sub (DB-9); male
Mini-DIN Keyboard/Barcode Reader		6-pin mini DIN (PS/2); female
Line Power ^a :		
Frequency	47 Hz to 63 Hz	
Voltage at 115 V setting	90 V to 132 V	115 V, nom.
Voltage at 220 V setting	198 V to 264 VAC	230 V, nom.
Power	300 VA, max	230 W, nom.
Front Panel		
RF Connectors		Type-N female; 50 Ω , nom. (<i>With Option 1EC only: Type-N female; 75 Ω, nom.</i>)
Probe Power: Positive Supply Negative Supply	200 mA, max 250 mA, max	3-pin connector; male +15 V, nom; 0.75 A fuse, nom; -12.6 V, nom; 0.75 A fuse, nom.

a. A third-wire ground is required.

Table 9-9 General Information (continued)

8712ET/ES and 8714ET/ES General Information		
Description	Specification	Supplemental Information
General Environmental		
ESD		Minimize using static-safe work procedures and an antistatic bench mat (part number 9300-0797).
Dust		Minimize for optimum reliability.
Operating Environment		
Temperature	0 °C to +55 °C	
Humidity	5% to 95% at +40° C	
Altitude	0 to 4.5 km (15,000 ft)	
Storage Conditions		
Temperature	-40° C to +70° C	
Humidity	0% to 95% RH at +65° C (noncondensing)	
Altitude	0 to 15.24 km (50,000 ft)	
Cabinet Dimensions		
Height × Width × Depth		179 × 425 × 514 mm, nom. (7.0 × 16.75 × 20.25 in, nom.) Cabinet dimensions exclude front and rear protrusions.
Weight		
Shipping		38 kg (84 lb.), nom.
Net		24.4 kg (54 lb.), nom.

Table 9-9 General Information (continued)

8712ET/ES and 8714ET/ES General Information								
Measurement Speed Conditions ^a					Typical			
Cal Type	Number of Chans	Meas BW	Number of Points	Freq Span ^b	Cycle Time ^c	Recall State & Cal ^d	Data Xfer ^e	Meas Cycle ^f
1-Port	1	6500	201	100 MHz	72 ms			
1-Port	1	6500	201	2 GHz	0.16 s			
1-Port	1	4000	11	100 MHz	37 ms			
1-Port	1	4000	21	100 MHz	42 ms			
1-Port	1	4000	51	100 MHz	55 ms	0.47 s	26 ms	0.63 s
1-Port	1	4000	101	100 MHz	76 ms			
1-Port	1	4000	201	100 MHz	0.12 s	0.58 s	38 ms	0.76 s
1-Port	1	4000	201	2 GHz	0.18 s			
1-Port	1	4000	401	100 MHz	0.21 s			
1-Port	1	4000	801	100 MHz	0.38 s			
1-Port	1	4000	1601	100 MHz	0.73 s	1.6 s	0.16 s	2.5 s
1-Port	1	3700	201	100 MHz	0.16 s			
1-Port	1	3700	201	2 GHz	0.22 s			
1-Port	1	1200	201	100 MHz	0.33 s			
1-Port	1	1200	201	2 GHz	0.40 s			
1-Port	1	250	201	100 MHz	1.5 s			
1-Port	1	250	201	2 GHz	1.6 s			
1-Port	1	15	201	100 MHz	12.3 s			
1-Port	1	15	201	2 GHz	12.3 s			
1-Port	2	4000	51	100 MHz	56 ms	0.63 s	58 ms	0.84 s
1-Port	2	4000	201	100 MHz	0.12 s	0.84 s	80 ms	1.1 s
1-Port	2	4000	1601	100 MHz	0.74 s	2.6 s	0.31 s	3.7 s
2-Port	1	4000	51	100 MHz	0.11 s	0.5 s	26 ms	0.72 s
2-Port	1	4000	201	100 MHz	0.24 s	0.67 s	38 ms	1.04 s
2-Port	1	4000	1601	100 MHz	1.5 s	2.2 s	0.16 s	3.95 s
2-Port	2	4000	51	100 MHz	0.11 s	0.71 s	60 ms	1.13 s
2-Port	2	4000	201	100 MHz	0.25 s	0.94 s	78 ms	1.47 s
2-Port	2	4000	1601	100 MHz	1.5 s	3.5 s	0.31 s	5.48 s

See footnotes on the following page.

- a. Measurements are always made with error correction enabled.
- b. Center frequency is set to 1 GHz.
- c. "Cycle Time" is the time required for the analyzer to finish one complete sweep cycle including the forward sweep, retrace, bandcrossings, and calculation time when in the "Continuous Sweep" mode.
- d. This is the time to recall both the system state and calibration data.
- e. "Data Transfer" is performed using an HP S700 workstation. The GPIB port is used to transfer "corrected" 64-bit, floating point numbers (real and imaginary).
- f. A "Measurement Cycle" is defined as the time required for an HP S700 workstation to control the analyzer to: (1) recall the state and calibration (analyzer is now in "sweep hold" mode), (2) sweep (using the ":INIT1;*OPC?" command), and (3) transfer data. This may be less than the sum of the other columns since a complete "Cycle Time" doesn't need to be done for the controller to transfer data.

Features

Measurement

Number of Display Measurements

Two measurement displays are available. Each measurement can have independent instrument sweep and control parameters (including frequency settings, IF bandwidth, power level, number of trace points, averaging, format, and scale). The instrument can display a single measurement or dual measurements, on a split (two graticules) or overlaid (one graticule) screen.

Measurement Choices

- **Narrowband:**

ET models: reflection (A/R), transmission (B/R), A, B, R

ES models: S_{11} (A/R), S_{22} (B/R), S_{21} (B/R), S_{12} (A/R), A, B, R

- **Broadband:** X, Y, Y/X, X/Y, Y/R*, power (B*, R*), conversion loss (B*/R*)

NOTE: X and Y denote external broadband-detector inputs; * denotes internal broadband detectors.

Formats

- rectilinear: log or linear magnitude, SWR
- phase, group delay, real and imaginary, Smith chart, and polar

Trace Functions

The analyzer can display current-measurement data, memory data or current-measurement with memory data simultaneously. Division of current-measurement data by memory data is also available.

Display Annotations

Analyzer display annotations include start/stop, center/span, or CW frequency, scale/division, reference level, marker data, softkey labels, warning and caution messages, screen titles, time and date, and pass/fail indication.

Limits

Measurement data can be compared to any combination of line or point limits for pass/fail testing. User-defined limits can also be applied to an amplitude- or frequency-reference marker. A limit-test TTL output is available on the rear panel for external control or indication. Limits are only available in rectilinear formats.

Data Markers

Each measurement channel has eight markers. Markers are coupled between channels. Any one of eight markers can be the reference marker for delta-marker operation. Annotation for up to four markers can be displayed at one time.

Marker Functions

Markers can be used in absolute or delta modes. Other marker functions include: mkr→center, mkr→reference, mkr→electrical delay, searches, tracking, and statistics. Marker searches include: mkr to max, mkr to min, mkr→target, mkr bandwidth, notch, multi-peak, and multi-notch. The marker-tracking function enables continuous update of marker search values on each sweep. Marker statistics enable measurement of the mean, peak-to-peak, and standard deviation of the data between two markers. For rapid tuning and testing of cable-TV broadband amplifiers, slope and flatness functions are also available.

Storage

Internal Memory

1.5 Mbytes of nonvolatile storage is available to store instrument states, measurement data, screen images, and IBASIC programs. Instrument states can include all control settings, limit lines, memory data, calibration coefficients, and custom display titles. If no other data files are saved in nonvolatile memory, between about 30 and 150 instrument states (depending on the instrument parameters) can be saved. Approximately 32 Mbytes of volatile memory is also available for temporary storage of instrument states, measurement data, screen images, and IBASIC programs.

Disk Drive

Trace data, instrument states (including calibration data), and IBASIC programs can also be saved on floppy disks using the built-in 3.5" disk drive. All files are stored in MS-DOS® -compatible format. Instrument data can be stored in binary or ASCII format (including Touchstone/.s1p format), and screen graphics can be saved as PCX (bit mapped), HP-GL (vector), or PCL5 (printer) files.

Network File System (NFS)

Remote files and directories, such as those stored on a computer, can behave like local files and directories stored within the analyzer through the use of NFS and the LAN interface. This allows test data from the analyzer to be saved directly to a remote directory—the remote machine does not have to initiate an ftp session to retrieve the data. The analyzer has a built-in bootp client. For Windows-based applications, third-party NFS-server software must be installed on the PC. NFS is fully supported in most versions of UNIX.

Data Hardcopy

Hardcopy prints can be made using PCL and PCL5 printers (such as HP DeskJet or LaserJet series of printers), or Epson-compatible graphics printers. Single color and multicolored formats are supported. Hardcopy plots can be automatically produced with HP-GL-compatible plotters such as the HP 7475A, or with printers that support HP-GL. The analyzer provides Centronics (parallel), RS-232C, GPIB, and LAN interfaces.

Automation

Controlling via GPIB

Interface: GPIB interface operates to IEEE 488.2 and SCPI standard interface commands.

Control: The analyzer can either be the system controller, or pass bus control to another active controller.

Data Transfer Formats:

- ASCII
- 32- or 64-bit IEEE 754 floating-point format
- mass memory-transfer commands allow file transfer between external controller and analyzer

Controlling via LAN

The built-in LAN interface and firmware support data transfer and control via direct connection to a 10 Base-T (Ethernet) network. A variety of standard protocols are supported, including TCP/IP, sockets, ftp, http, telnet, bootp, and NFS. The LAN interface is a standard feature.

SCPI: The analyzer can be controlled by sending Standard Commands for Programmable Instruments (SCPI) commands within a telnet session or via a socket connection and TCP/IP (the default socket port is 5025). The analyzer's socket applications programming interface (API) is compatible with Berkeley sockets, Winsock and other standard socket APIs. Socket programming can be done in a variety of environments, including C programs, HP VEE, SICL LAN, or Java applets. A standard web browser and the analyzer's built-in web page can be used to remotely enter SCPI commands via a Java applet.

FTP: Instrument state and data files can be transferred via file-transfer protocol (ftp). An internal dynamic data disk, which is an ftp directory, provides direct access to instrument states, screen dumps, trace data, and operating parameters.

HTTP: The instrument's built-in web page can be accessed with any standard web browser using hypertext transfer protocol (http) and the analyzer's IP address. The built-in web page can be used to control the network analyzer, view screen images, download documentation, and link to other sites for firmware upgrades and *VXIplug&play* drivers. Some word processor and spreadsheet programs, such as Microsoft Word 97® and Excel 97®, provide methods to directly import graphics and data with http via a LAN connection.

SICL LAN: SICL LAN is a LAN protocol using the Standard Instrument Control Library (SICL). It provides control of your analyzer over the LAN using a variety of computing platforms, I/O interfaces, and operating systems. With SICL LAN, a remote analyzer can be controlled over the LAN with the same methods used for a local analyzer connected directly to the controller with GPIB. SICL LAN can also be used with Windows 95/98/NT, or HP-UX.

Bootp: Bootstrap protocol (bootp) allows a network analyzer to automatically configure itself at power-on with the necessary information to operate on the network. After a bootp request is sent by the analyzer, the host server downloads an IP address, a gateway address, and a subnet mask. In addition, the analyzer can request an IBASIC file, which automatically executes after the transfer is complete. For Windows-based applications, third-party bootp-server software must be installed on the PC. Bootp is fully supported in most versions of UNIX.

Programming using IBASIC

As a standard feature, all 8712ET/ES and 8714ET/ES network analyzers come with the Instrument BASIC programming language (IBASIC). IBASIC facilitates automated measurements and control of other test equipment, improving productivity. For simpler applications, you can use IBASIC as a keystroke recorder to easily automate manual measurements. Or, you can use an optional, standard PC keyboard to write custom test applications that include:

- special softkey labels
- tailored user prompts
- graphical setup diagrams
- barcode-reading capability
- control of other test instruments via the GPIB, serial or parallel interfaces

Measurement Calibration

Measurement calibration significantly reduces measurement uncertainty due to errors caused by system directivity, source match, load match, frequency response, and crosstalk. The analyzer features factory-installed default calibrations that use vector error correction, so that measurements can be made on many devices without performing a user calibration.

For greater accuracy, especially for special test setups with significant loss or reflection, user calibrations should be performed. For reflection measurements, both one-port and two-port calibrations are available (two-port calibration requires an ES model). For transmission measurements, the following calibrations are available: response, response and isolation, enhanced response, and two-port (two-port calibration requires an ES model).

Calibration Interpolation

Calibration interpolation is always active. The analyzer automatically recalculates the error coefficients when the test frequencies or the number of points have changed. The resulting frequency range must be within the frequency range used during the user calibration. If this is not the case, the analyzer reverts to the factory default calibration. When calibration interpolation is used, the analyzer displays the C? annotation. System performance is not specified for measurements using calibration interpolation.

Available Calibrations

ES models only

- **Two-Port Calibration**

Compensates for frequency response, load match, source match, and directivity errors while making S-parameter measurements of transmission (S_{21} , S_{12}) and reflection (S_{11} , S_{22}). Compensates for crosstalk when the **Isolation on OFF** softkey is toggled ON. Requires open, short, load, and through standards.

ET and ES models: transmission measurements

- **Normalization**

Simultaneous magnitude and phase correction of frequency response errors. Requires a through connection. Used for both narrowband and broadband detection. Does not support calibration interpolation.

- **Response**

Simultaneous magnitude and phase correction of frequency response errors. Requires a through connection.

- **Response and Isolation**

Compensates for frequency response and crosstalk errors. Requires a load termination on both test ports and a through standard.

- **Enhanced Response**

Compensates for frequency response and source match errors. Requires open, short, load and through standards.

ET and ES models: reflection measurements

- **One-Port calibration**

Compensates for frequency response, directivity, and source match errors. Requires an open, short, and load standards.

Calibration Kits

Data for several standard calibration kits are stored in the instrument for use by calibration routines. They include:

- 3.5 mm (85033D with Option 001^a)
- type-F 75 ohm (85039B)
- type-N 50 ohm (85032B with Option 001^a, or 85032E^b)
- type-N 75 ohm (85036B/E^b)
- 7 mm (APC-7) (85031B)
- 7-16 (85038A^c/F^d/M^e)

In addition, you can also describe the standards for a user defined kit (for example, open-circuit capacitance coefficients, offset short length, or through-standard loss).

For more information about calibration kits available from Agilent Technologies, consult the RF Economy Network Analyzers Configuration Guide, literature number 5967-6315E.

-
- a. Option 001 doesn't include 7 mm adaptors.
 - b. "E" version doesn't include adaptors or cal standards with female connectors.
 - c. Contains cal standards with female connectors and male connectors.
 - d. Contains cal standards with female connectors only.
 - e. Contains cal standards with male connectors only.

Options

75 Ohms (Option 1EC)

Provides 75 ohm system impedance.

Fault location and structural return loss (Option 100)

For fully characterizing cable performance and antenna-feedline systems, this option provides both fault location and structural return loss capability. Fault-location measurements help identify where cable or system faults, such as bends, shorts, or corroded or damaged connectors, occur. In addition to displaying faults in terms of distance into the cable or feedline, the magnitude of the fault is also displayed.

Structural return loss is a special case of return loss (reflection) measurements, optimized for measuring periodic reflections of small magnitude. These periodic reflections can occur from physical damage to the cable caused by rough handling, or from minor imperfections imparted during the manufacturing process. Structural return loss problems occur when these periodic reflections sum at half-wavelength intervals, causing high signal reflection (and low transmission) at the corresponding frequency.

Step Attenuator (Option 1E1): *8712ET/8714ET only*

This option adds a built-in 60 dB step attenuator, extending the source output power low-end range to -60 dBm. This attenuator is a standard feature on the 8712ES/8714ES.

Transport case and fault location and structural return loss (Option 101)

Combines a rugged transport and operation case (part number 08712-60059) with Option 100 for field measurements of fault location and structural return loss.

Test Sets

87050E multiport test sets

Provides a complete solution for testing 50 ohm multiport devices like duplexers, power dividers, or multi-couplers. Test sets can be configured with four, eight, or twelve test ports (for more information, please consult the product brochure, literature number 5968-4763E).

87075C multiport test sets

Provides a complete solution for testing 75 ohm multiport devices like CATV distribution amplifiers or multi-taps. Test sets can be configured with six or twelve test ports (for more information, please consult the product brochure, literature number 5968-4766E).

Switching test sets

Switching test sets enhance productivity by allowing multiple measurements with a single connection to the device under test. They are available in 50 and 75 ohm versions, in a variety of configurations and connector types. Please contact your Agilent Technologies sales representative for more information.

Warranty

NOTE The actual warranty on your instrument depends on the date it was ordered as well as whether or not any warranty options were purchased at that time. To determine the exact warranty on your instrument, contact the nearest Agilent Technologies sales or service office with the model and serial number of your instrument. See [Table 9-10](#) for a list of sales and service offices.

This Agilent Technologies instrument product is warranted against defects in material and workmanship for the warranty period. During the warranty period, Agilent Technologies will, at its option, either repair or replace products which prove to be defective.

If the warranty covers repair or service to be performed at the Buyer's facility, then the service or repair will be performed at the Buyer's facility at no charge within Agilent service travel areas. Outside Agilent service travel areas, warranty service will be performed at Buyer's facility only upon Agilent's prior agreement, and Buyer shall pay Agilent's round-trip travel expenses. In all other areas, products must be returned to a service facility designated by Agilent.

If the product is to be returned to Agilent Technologies for service or repair, it must be returned to a service facility designated by Agilent. Buyer shall prepay shipping charges to Agilent and Agilent shall pay shipping charges to return the product to Buyer. However, Buyer shall pay all shipping charges, duties, and taxes for products returned to Agilent from another country.

Agilent Technologies warrants that its software and firmware designated by Agilent for use with an instrument will execute its programming instructions when properly installed on that instrument. Agilent does not warrant that the operation of the instrument, or software, or firmware will be uninterrupted or error-free.

Limitation of Warranty

The foregoing warranty shall not apply to defects resulting from improper or inadequate maintenance by Buyer, Buyer-supplied software or interfacing, unauthorized modification or misuse, operation outside of the environmental specifications for the product, or improper site preparation or maintenance.

NO OTHER WARRANTY IS EXPRESSED OR IMPLIED.
HEWLETT- PACKARD SPECIFICALLY DISCLAIMS THE IMPLIED WARRANTIES OF MERCHANTABILITY AND FITNESS FOR A PARTICULAR PURPOSE.

Exclusive Remedies

THE REMEDIES PROVIDED HEREIN ARE BUYER'S SOLE AND EXCLUSIVE REMEDIES. AGILENT TECHNOLOGIES SHALL NOT BE LIABLE FOR ANY DIRECT, INDIRECT, SPECIAL, INCIDENTAL, OR CONSEQUENTIAL DAMAGES, WHETHER BASED ON CONTRACT, TORT, OR ANY OTHER LEGAL THEORY.

Agilent Technologies Sales and Service Offices

If you should need technical assistance, contact the nearest Agilent Technologies sales or service office. See [Table 9-10](#) on the next page.

Table 9-10 Agilent Technologies Sales and Service Offices

UNITED STATES		
Instrument Support Center Agilent Technologies, Inc. (800) 403-0801		
EUROPEAN FIELD OPERATIONS		
Headquarters Agilent Technologies S.A. 150, Route du Nant-d'Avril 1217 Meyrin 2/ Geneva Switzerland (41 22) 780.8111	France Agilent Technologies France 1 Avenue Du Canada Zone D'Activite De Courtaboeuf F-91947 Les Ulis Cedex France (33 1) 69 82 60 60	Germany Agilent Technologies GmbH Agilent Technologies Strasse 61352 Bad Homburg v.d.H Germany (49 6172) 16-0
Great Britain Agilent Technologies Ltd. Eskdale Road, Winnersh Triangle Wokingham, Berkshire RG41 5DZ England (44 118) 9696622		
INTERCON FIELD OPERATIONS		
Headquarters Agilent Technologies Inc. 3495 Deer Creek Rd. Palo Alto, CA 94304-1316 USA (650) 857-5027	Australia Agilent Technologies Australia Ltd. 31-41 Joseph Street Blackburn, Victoria 3130 (61 3) 895-2895	Canada Agilent Technologies (Canada) Ltd. 17500 South Service Road Trans-Canada Highway Kirkland, Quebec H9J 2X8 Canada (514) 697-4232
Japan Agilent Technologies Japan, Ltd. Measurement Assistance Center 9-1, Takakura-Cho, Hachioji-Shi Tokyo 192-8510, Japan TEL (81)- 426-56-7832 FAX (81)- 426-56-7840	Singapore Agilent Technologies Singapore (Pte.) Ltd. 150 Beach Road #29-00 Gateway West Singapore 0718 (65) 291-9088	Taiwan Agilent Technologies Taiwan 8th Floor, H-P Building 337 Fu Hsing North Road Taipei, Taiwan (886 2) 712-0404
China China Agilent Technologies Co. 38 Bei San Huan X1 Road Shuang Yu Shu Hai Dian District Beijing, China (86 1) 256-6888		

10

Safety and Regulatory Information

Safety and Regulatory Information

This chapter contains required safety and regulatory information that is not included elsewhere in the manual.

Safety Information

Much of the required safety information is distributed throughout this manual in appropriate places. This section contains all required safety information that is not included elsewhere in this manual.

Warnings

Warning Definition

Warning denotes a hazard. It calls attention to a procedure which, if not correctly performed or adhered to, could result in injury or loss of life. Do not proceed beyond a warning note until the indicated conditions are fully understood and met.

Warnings applicable to this instrument are:

WARNING

No operator serviceable parts inside. Refer servicing to qualified personnel. To prevent electrical shock, do not remove covers.

WARNING

If this product is not used as specified, the protection provided by the equipment could be impaired. This instrument must be used in a normal condition (in which all means for protection are intact) only.

WARNING

For continued protection against fire hazard replace line fuse only with same type and rating (T 5 A/250 V). The use of other fuses or material is prohibited.

WARNING

This is a Safety Class I product (provided with a protective earthing ground incorporated in the power cord). The mains plug shall only be inserted in a socket outlet provided with a protective earth contact. Any interruption of the protective conductor, inside or outside the instrument, is likely to make the instrument dangerous. Intentional interruption is prohibited.

Cautions

Caution Definition Caution denotes a hazard. It calls attention to a procedure that, if not correctly performed or adhered to, would result in damage to or destruction of the instrument. Do not proceed beyond a caution sign until the indicated conditions are fully understood and met.

Cautions applicable to this instrument are:

CAUTION

Always use the three-prong ac power cord supplied with this instrument. Failure to ensure adequate earth grounding by not using this cord may cause product damage.

Statement of Compliance

This instrument has been designed and tested in accordance with IEC Publication 1010, Safety Requirements for Electronic Measuring Apparatus, and has been supplied in a safe condition. The instruction documentation contains information and warnings which must be followed by the user to ensure safe operation and to maintain the instrument in a safe condition.

Cleaning Instructions









WARNING

To prevent electrical shock, disconnect the analyzer from mains before cleaning. Use a dry cloth or one slightly dampened with water to clean the external case parts. Do not attempt to clean internally.

Shipping Instructions

Always transport or ship the instrument using the original packaging or comparable.

Instrument Markings

	The instruction manual symbol. The product is marked with this symbol when it is necessary for the user to refer to the instructions in the manual.
	The CE mark is the registered trademark of the European Community.
	The CSA mark is a registered trademark of the Canadian Standards Association.
	This is a symbol of an Industrial Scientific and Medical Group 1, Class A product.
	The "ON" symbol is used to mark the position of the analyzer's line power switch.
	The "STANDBY" symbol is used to mark the position of the analyzer's power switch.
	The AC symbol is used to indicate the required nature of the line module input power.
	The C-Tick mark signifies compliance with an EMC requirement. It is a registered trademark of the Australian Spectrum Management Agency.

Regulatory Information

Notice for Germany: Noise Declaration

LpA < 70 dB
am Arbeitsplatz (operator position)
normaler Betrieb (normal position)
nach DIN 45635 T. 19 (per ISO 7779)

Declaration of Conformity

DECLARATION OF CONFORMITY

According to ISO/IEC Guide 22 and CEN/CENELEC EN 45014

Manufacturer's Name: Agilent Technologies, Inc.

Manufacturer's Address: 1400 Fountaingrove Parkway
Santa Rosa, CA 95403-1799
USA

Declares that the products

Product Name: RF Network Analyzer

Model Number: 8712ES, 8712ET, 8714ES, 8714ET

Product Options: This declaration covers all options of the above products.

Conform to the following product specifications:

EMC: IEC 61326-1:1997+A1:1998 / EN 61326-1:1997+A1:1998

<u>Standard</u>	<u>Limit</u>
CISPR 11:1990 / EN 55011-1991	Group 1, Class A
IEC 61000-4-2:1995+A1998 / EN 61000-4-2:1995	4 kV CD, 8 kV AD
IEC 61000-4-3:1995 / EN 61000-4-3:1995	3 V/m, 80 - 1000 MHz
IEC 61000-4-4:1995 / EN 61000-4-4:1995	0.5 kV sig., 1 kV power
IEC 61000-4-5:1995 / EN 61000-4-5:1996	0.5 kV L-L, 1 kV L-G
IEC 61000-4-6:1996 / EN 61000-4-6:1998	3 V, 0.15 – 80 MHz
IEC 61000-4-11:1994 / EN 61000-4-11:1998	1 cycle, 100%

Safety: IEC 61010-1:1990 + A1:1992 + A2:1995 / EN 61010-1:1993 +A2:1995
CAN/CSA-C22.2 No. 1010.1-92

Supplementary Information:

The products herewith comply with the requirements of the Low Voltage Directive 73/23/EEC and the EMC Directive 89/336/EEC and carry the CE-marking accordingly.



Santa Rosa, CA, USA 17 May 2000

Greg Pfeiffer/Quality Engineering Manager

For further information, please contact your local Agilent Technologies sales office, agent or distributor.

11 **Factory Preset State and Memory Allocation**

Factory Preset and Peripheral States

Factory Preset State

When the network analyzer is preset with the **PRESET** and **Factory Preset** keys, or with the SCPI command "SYST:PRESET", it sets itself to the pre-defined conditions shown below.

NOTE

The GPIB command "*RST" is not the same as "SYST:PRESET".

BEGIN Key Settings

BEGIN key device	None
-------------------------	------

MEAS Key Settings

MEAS 1 On/Off Measurement	On S ₂₁ Fwd Trans
MEAS 2 On/Off Measurement	Off S ₂₁ Fwd Trans

SOURCE Key Settings

FREQ	
Start frequency	0.3 MHz
Stop frequency ¹	1300 MHz
Stop frequency ²	3000 MHz
Low pass/Band pass ³	Low pass
Band pass max span ^{1,3}	1299.700 MHz
Band pass max span ^{2,3}	2999.700 MHz
Frequency resolution	kHz
SWEEP	
Sweep type	Frequency
Alternate sweep	Off
Sweep time	Auto (fastest possible)
POWER	
Power level	preset power level ⁴
RF power	On
Power sweep start power	0.0 dBm
Power sweep stop power	1.0 dBm

1. 8712ES
2. 8714ES
3. Analyzers with Option 100 only
4. Preset power level is user-defined by using the **Pwr Level at Preset** key. The factory default is 0 dBm.

SOURCE Key Settings (continued)

MENU	
Trigger source	Internal
Trigger mode	Continuous
Number of points	201
Start distance ¹	0.00 ft (0.00 m)
Stop distance ¹	100.00 ft (30.48 m)
External reference	Off
Spur avoid options	None

1. Analyzers with Option 100 only

CONFIGURE Key Settings

SCALE	
Scale/div	10 dB/div
Reference level	0 dB
Reference position	5
Reference tracking	Off
Electrical delay	0 seconds
Phase offset	0 degrees
DISPLAY	
Full/split display	Full
Display trace	Data
Graticule	On
Measurement channel annotation	On
Frequency annotation	On
Marker annotation	On
Marker numbers	On
Y-axis label state	On
Y-axis label mode	Absolute
Title + Clock	Off
Clock title line	Clock on line 2
Title line 1	Blank
Title line 2	Blank
Limit lines	On
Limit pass/fail text	On

CONFIGURE Key Settings (continued)

Limit fail icon	On
Limit pass/fail indicator "X" position	80%
Limit pass/fail indicator "Y" position	60%
Marker limits	Off
Limit test	Off
Previously set limits	Deleted
CAL	
Active calibration	Last active cal if valid; otherwise, default cal
Detector zero	Autozero
Cal kit	Type-N female
System Z_0	50 ohms ¹
Velocity factor ²	1.0 (speed of light)
Smith chart Z_0	50 ohms ¹
Port extensions	Off
Refl port extensions	0 s
Trans port extensions	0 s
MARKER	
On/off	All off
Delta marker state	Off
Search	Off
Bandwidth search level	-3

1. 75 ohms if your analyzer is Option 1EC (75 ohm test ports)
2. See "Peripheral State" on page 11-8 for analyzers with Option 100.

CONFIGURE Key Settings (continued)

Notch search level	-6
Target search level	-3
Tracking	Off
FORMAT	
Format type	Log mag
AVG	
Averaging	Off
Average factor	16
System bandwidth	Medium Wide
Fault Window ¹	Medium
Delay Aperture	0.5% (minimum)

1. Analyzers with Option 100 only

SYSTEM Key Settings

SAVE RECALL	
Define save	Instrument state = On Cal = Off Data = Off
HARDCOPY	
See "Peripheral State"	
SYSTEM OPTIONS	
Beeper volume	90%
IBASIC display	None

Peripheral State

The analyzer is shipped from the factory with the settings in the following table. These settings will remain as shown, until you change them. When they have been changed and you then preset the analyzer with the **PRESET** hardkey, or the SCPI command "SYST:PRESET", or cycle power, the settings are saved in non-volatile memory and thus are not lost.

NOTE

These settings can be restored by pressing the **PRESET** key several times during power-up. This procedure clears all information in non-volatile memory, including calibrations. Refer to the **PRESET** key definition on [page 8-39](#) for more information.

BEGIN Key Settings

User BEGIN menu	Off
-----------------	-----

MENU Key Settings

Distance Units ¹	Feet
-----------------------------	------

1. Analyzers with Option 100 only

DISPLAY Key Settings

Color options (for external monitor)	Factory default
--------------------------------------	-----------------

CAL Key Settings

Velocity factor ¹	1.0 (speed of light)
------------------------------	----------------------

1. Option 100 only. For analyzers without Option 100, see "[Factory Preset State](#)" on [page 11-2](#).

SAVE RECALL Key Settings

Save ASCII format	Lotus
Select Disk	Non-Vol RAM disk
Volatile RAM disk percent	20%
IBASIC file type	ASCII

SYSTEM OPTIONS Key Settings

Analyzer GPIB Address	16
System Controller/Talker Listener	Talker Listener
Power Meter GPIB Address ¹	13
System Controller Address ²	21
User TTL Config	Softkey Auto-Step
Clock:	
Format	YYYY-MM-DD HH:MM:SS
Numeric/Alpha	Numeric
Seconds	On
GPIB:	
Status	Talker/Listener
SRE Register	0
ESE Register	0
PSC Flag	1
LAN	
LAN state	On
87xxx IP Address	0.0.0.0
Gateway IP Address	0.0.0.0
Subnet Mask	0.0.0.0

1. This address cannot be changed.
2. This address cannot be changed from the front panel of your analyzer. It can only be changed using the "*PCB" command. See your *Programmer's Guide* for details.

HARDCOPY Key Settings

Select Copy Port:	
Hardcopy Device	HP printer
Printer Language	PCL
Hardcopy Port	parallel
Printer/Plotter GPIB Address	5
Baud Rate	19200
Handshake	Xon/Xoff
Define Hardcopy	Graph and Marker Table
Define Graph:	
Trace Data	On
Graticule	On
Annotation	On
Marker Symbol	On
Title + Clock	On
Define PCL5	
Mono/Color	Monochrome
Orientation	Portrait
Auto Feed	On
Top Margin	0 mm
Left Margin	0 mm
Print Width	150 mm (5.9 in)

HARDCOPY Key Settings (continued)

Define Printer:	
Mono/Color	Monochrome
Orientation	Portrait
Auto Feed	On
Resolution	96 dpi
Top Margin	0 mm
Left Margin	0 mm
Print Width	150 mm (5.9 in)
Define Plotter:	
Mono/Color	Monochrome
Auto Feed	On
Pen Numbers:	
Monochrome	Pen 1
Trace 1	Pen 1
Trace 2	Pen 2
Memory 1	Pen 3
Memory 2	Pen 4
Graticule	Pen 5
Graphics	Pen 6

Volatile Settings

A few of the analyzer's settings that are not included in the previous sections are volatile. These settings survive when the **PRESET** key is pressed, but *not* when the analyzer's power is cycled.

Examples of volatile settings are:

File Format

always returns to "8712E Compatible" format after a power cycle.

IP Address to Ping

always returns to 0.0.0.0 after a power cycle.

Save/Recall Memory Allocation

Before reading this section, please refer to “Using Instrument Functions” in Chapter 4 for an overview of the Save/Recall functions.

This section provides details on the size of Save/Recall instrument state files. Since disks have limited storage capacities, it is often important to know how many instrument state files will fit on a disk, and how to reduce the size of each file in order to maximize storage.

Types of Storage Disks

The analyzer is capable of saving complete instrument states for later retrieval. It can store these instrument states to any one of the following:

Table 11-1

Disk Capacities

Disk	Capacity
Internal non-volatile RAM disk	950 KB
Internal volatile RAM disk	over 5 MB to 23 MB
Internal 3.5” floppy disk	1.44 MB

The non-volatile RAM disk is powered by a battery, to provide short term storage of data when the analyzer is not connected to ac power. With this battery protection, data can typically be retained in memory for approximately 250 days at 70 °C and for more than 5 years at 25 °C.

The number of files that can be saved to disk is limited by the space available on the disk.

The number of bytes available for storage are displayed in the upper right-hand portion of the disk catalog window, after the words "Bytes Free."

In addition, each directory can only hold a limited number of files or directories. The following table shows these limits:

Table 11-2 **Maximum Number of Files and Directories**

	Root Directory	Any Subdirectory
Non-volatile RAM Disk	128	>1000
Volatile RAM Disk	256	>1000

If you have more files than will fit in a single directory, use additional subdirectories. With fewer files in each directory, your disk access time will be faster.

The **SAVE RECALL** disk catalog window can display at most nine pages of files, with 21 files or directories per page, for a total of 189. This means that if you have over 188 files (in addition to the parent directory), you will not be able to see all of the files. However, even though you cannot see all of the files using the disk catalog window, you can still access them programmatically using SCPI or IBASIC.

Types of Storable Information

The instrument states can contain the instrument state, calibration data, and trace data.

- Inst State** (Instrument state) Data sufficient to set up the network analyzer. The amount of memory used is independent of the number of measurement points unless memory trace functions are used. Memory trace functions are **Data/Mem** and **Data and Memory** . You should save instrument states when you want to return to the same instrument setup.
- Cal** (Calibration data) Error correction arrays. The amount of memory used increases with the number of data points. Reflection cals are larger than transmission cals. The instrument state is automatically saved with cal data. You should save calibrations to avoid having to repeat the calibration procedure.
- Data** (Measurement or trace data) The amount of memory used increases with the number of data points. When data is put into memory (by pressing **Data->Mem**) it becomes a memory trace.
- Save ASCII** Saves trace data in ASCII format for output to spreadsheets or to CAE programs.

How to Determine the Size of Disk Files

This section explains how to calculate the size of the files that you save to disk when using **SAVE RECALL**.

As mentioned earlier, there are three types of information that can be saved:

- Instrument state
- Cal
- Data

Each of these can be enabled or disabled using **SAVE RECALL** **Define Save**, based on your needs.

The following table shows how much space is required to save each of the three components of the instrument state. By adding the numbers for the items which you are saving, you can calculate, approximately, the size of the instrument state file that will be saved to disk.

Table 11-3 Sizes of Instrument State Components

Item Saved	Size ¹ (bytes)
File header ²	0
State header	140
Instrument state	
off	0
without memory trace	9580
with 1 memory trace ³	$9580 + 1 \times 8 \times N_{pts}$
with 2 memory traces ³	$9580 + 2 \times 8 \times N_{pts}$
Data (per active channel)	
off	0
each channel active ³	$178 + 8 \times N_{pts}$
Cal (per active channel)	
off	0
response ⁴	$246 + 4 \times 8 \times Cal_{pts}$
response and isolation ⁴	$246 + 4 \times 8 \times Cal_{pts}$
enhanced response ⁴	$246 + 4 \times 8 \times Cal_{pts}$
reflection ⁴	$246 + 3 \times 8 \times Cal_{pts}$
two-port ⁴	$246 + 12 \times 8 \times Cal_{pts}$

1. Sizes are subject to change with future firmware revisions.
2. If the file format chosen is "8711A/B Compatible," the file header size is 768.
3. N_{pts} = number of measurement points
4. Cal_{pts} = number of points over which the calibration was performed

Memory traces are saved with the instrument state for each active channel whose display is set to Memory, Data/Mem, or Data and Memory in the **DISPLAY** menu.

Following are some examples:

- **PRESET** state, saving instrument state only:

$$\text{Size} = 0 + 140 + 9580 = 9720$$

- Using 201 points, with Data/Mem on channel 1, channel 2 off:

$$\text{Size} = 0 + 140 + 9580 + (8 \times 201) = 11,328$$

- Using 201 points, with Data/Mem on channel 1, channel 2 off, and saving both the instrument state and data:

$$\text{Size} = 0 + 140 + 9580 + (8 \times 201) + 178 + (8 \times 201) = 13,114$$

- Same as above, but after performing a two-port calibration and saving the calibration:

$$\text{Size} = 0 + 140 + 9580 + (8 \times 201) + 178 + (8 \times 201) + 246 + (12 \times 8 \times 201) = 32,656$$

NOTE

Most disks use a sector size of 256 or 512 bytes, so there will usually be a small amount of wasted space on the disk.

Memory Usage Notes

In general, memory usage increases with number of points and complexity of information saved.

One-port reflection calibrations use more memory than transmission calibrations because they use more error arrays.

Two-port calibrations use more memory than other calibration types.

When multiple types of information are saved together, the total can be less than indicated above because redundant internal information is eliminated.

Numerics

1 key ... 8 key, 8-3
10 MHz reference, 7-4
3.5 mm cal kit, 8-3
3.5 mm key, 8-3
50 ohm key, 8-3
7-16 cal kit, 8-4
7-16 key, 8-4
75 ohm key, 8-3
8711A/B Compatible key, 8-4
8711C Compatible key, 8-4
8712E Compatible key, 8-4
8712ES Address key, 8-5
8712ES IP Address key, 8-5
8714ES Address key, 8-5
8714ES IP Address key, 8-5

A

A detector, 3-4
A key, 8-6
A/R key, 8-6
Abort key, 8-6
Abort Kit key, 8-6
absolute output power,
 measuring, 3-57
accessing files from disk, 4-66
activating spur avoidance, 5-13
Active Marker Off key, 8-6
active measurement channel, 2-7
Add Kit Description key, 8-7
Add Limit key, 8-7
Add Login User key, 8-7
Add Max Line key, 8-7
Add Max Point key, 8-7
Add Min Line key, 8-8
Add Min Point key, 8-8
address
 GPIB, 1-14
 plotter, 1-14
 printer, 1-14

Agilent Technologies sales and
 service offices, 9-58
All Off key, 8-8
allocations, memory, changing,
 4-59
Alpha key, 8-8
Alt Sweep key, 8-8
alternate sweep, 5-7
alternate sweep key, 8-8
amplification, when to use in a
 measurement, 3-12
Amplifier key, 8-8
amplitude, delta marker limit, 4-35
annotation
 frequency, 4-51
 marker number, 4-51
 measurement channel, 4-51
 options, 4-45
 x-axis, 4-51
Annotation ON off key, 8-9
Annotation Options key, 8-9
APC-7 cal kit, 8-9
APC-7 key, 8-9
aperture, 3-70
Aperture (%) key, 8-9
Aperture (Hz) key, 8-9
arrays, error correction, 6-3
ASCII file, calibration kit, 6-30
attenuation, when to use in a
 measurement, 3-12
Authentication key, 8-9
Auto Feed ON off key, 8-10
Automount At Powerup, 8-10
Automount Dev Table key, 8-10
Automount Setup key, 8-10
Autoscale, 2-6
Autoscale key, 8-10
AUTOST files, 3-19
Autost key, 3-19, 8-10
auto-step, 4-64
Autozero, 6-22
Autozero key, 8-11

AUX INPUT connector, 3-68, 7-4
Aux Input key, 8-11
auxiliary input, 3-68, 7-4
Average Factor key, 8-11
Average on OFF key, 5-11, 8-11
averaging
 changing, 5-11
 explanation, 5-12
 indicator, 5-11
AVG key, 8-11

B

B detector, 3-4
B key, 8-12
B* detector, 3-6
B* key, 8-12
B*/R* key, 8-12
B/R key, 8-12
bandwidth change, 5-10, 5-12
Bandwidth key, 8-13
bandwidth, marker search, 4-10
bandwidth, system, 5-10
basic functions, front panel, 2-3
battery, 11-13
baud rate, 4-74
Baud Rate key, 8-13
Beeper Volume key, 8-13
Begin Frequency key, 8-13
BEGIN key, 3-15, 8-13
 customized, 3-19
 measurement configurations,
 3-15
 network analyzer internal
 configurations, 3-18
 user defined, 3-19
Begin Limit key, 8-13
BNC connectors, 7-4, 7-6
BOOTP on OFF key, 8-13
BOOTP Setup key, 8-14
broadband detection mode, 3-6
Broadband External key, 8-14
Broadband Internal key, 8-14

Broadband Passive key, 8-14
broadband power measurement,
3-57
built-in disk drive
MS-DOS formatting, 4-69

C

C notation, 7-17
C? notation, 7-17
C0 key, 8-15
C1 key, 8-15
C2 key, 8-15
C3 key, 8-15
cabinet installation, 1-16
Cable key, 8-15
cables, interface, 4-71
CAL key, 8-15
Cal Kit key, 8-16
cal kit. *See* calibration kit
Cal on OFF key, 8-16
calibration
choices, 6-10
conversion loss, 6-22
crosstalk, 8-44
default, 6-8
default one-port, 6-19, 8-22
default response, 6-15, 8-24
default two-port, 6-16, 8-22
enhanced response, 3-42, 6-17,
8-29
group delay measurement, 3-
72
impedance measurement, 3-75
insertable devices, 3-22
isolation, 6-16, 6-17, 6-20, 6-
21, 8-44, 8-73
noninsertable devices
modify the cal kit definition
method, 3-26
DUT has different connector
types, 3-36
DUT has same connecto

types, 3-30
swap equal adapters method,
3-26
normalize, 6-14, 8-62
one-port. *See* calibration, user
one-port.
phase-derived delay
measurement, 3-72
presetting the analyzer, 6-13
reflection, 6-19
response, 6-16, 8-73
response and isolation, 6-17
retrieving previous
calibrations, 6-12
S₁₁, 3-50, 3-52, 6-19
S₁₂, 3-42, 6-15
S₂₁, 3-42, 6-15
S₂₂, 3-50, 6-19
saving, 4-60, 6-33
S-parameter measurements, 3-
21
theory, 6-3
transmission, 6-15
two-port. *See* calibration, user
two-port.
user one-port, 3-50, 6-21, 8-94
user response, 8-96
user two-port, 3-21, 3-23, 3-72,
3-75, 6-5, 6-17, 6-21, 8-95
user-defined versus default, 6-
8
calibration information
to save, 4-57
calibration kit, 6-23
3.5 mm, 6-24
7-16, 6-24
7-16, 8-4
aborting a modification, 8-6
APC-7, 6-24, 8-9
ASCII file, 6-30
downloading standards, 6-31
modifying, 8-58
sex of connectors, 3-22

stored in analyzer, 6-23
type-F, 6-24, 8-93
type-N(f), 6-24, 8-93
type-N(m), 6-24, 8-93
user cal kit (A-J), 8-95
user-defined, 6-25
creating, 6-28
calibration reference plane, 6-7
calibration standard, 6-26
load, 6-26, 8-49
open, 6-26, 8-63
short, 6-26, 8-81
through, 6-26, 8-90
calibration standard
characteristic, 6-26
C0, C1, C2, C3, 6-28, 8-15
delay, 6-27, 8-24
loss, 6-27, 8-50
Z0, 8-103
Z₀, 6-27
Cancel key, 8-16
caution
definition, 10-4
receiver input damage level, 5-
9
CE mark definition, 10-5
Center key, 2-6, 8-16
change directories, 4-68
Change Directory key, 8-16
changing directories, 4-68
channel
selecting, 2-7
viewing, 2-8
characteristics of calibration
standards, 6-26
check, operator's, 2-10
checking the shipment, 1-3
choices, calibration, 6-10
cleaning instructions, 10-4
Clear Entry key, 8-16
Clear Program key, 8-17
clock, 4-50
Clock Format key, 8-17

Index

- Clock Off key, 8-17
- coaxial connectors, 7-4, 7-6
- color display, 4-89
- Color key, 8-17
- Color Options key, 4-89, 8-18
- compatible printers, 4-70
- confidence check, 2-10
- confidence check, failure, 2-17
- configure the hardcopy port, 4-73
- Configure VOL_RAM key, 8-18
- configuring
 - measurements from the BEGIN key, 3-15
 - memory allocations, 4-59
 - the analyzer, 1-10
- Confirm Password key, 8-18
- connecting
 - computers, 1-11
 - controllers, 1-11
 - peripherals, 1-11
- connectors, 7-2
 - care, 1-17
 - coaxial, 7-4, 7-6
 - damage levels, 7-4, 7-6
 - front panel, 7-3
 - GPIB, 7-7
 - impedances, 7-4, 7-6
 - multi-pin, 7-7, 7-14
 - rear panel, 7-4
 - specs, 1-17
- contents of shipment, 1-3
- Continue key, 8-18
- Continuous key, 8-18
- control, intensity, 7-20
- controllers, connecting, 1-11
- conversion loss
 - calibration, 6-22
 - formula, 3-66
 - measuring, 3-62
- Conversion Loss key, 8-18
- Copy All Files key, 8-19
- Copy File key, 8-19
- Copy to 3.5 Disk key, 8-19
- Copy to NonVol RAM key, 8-19
- Copy to Vol RAM key, 8-19
- crosstalk, 8-73
- crosstalk calibration, 8-44
- CRT Adjust, 4-91
- CRT Adjust key, 8-19
- CRT adjustment, for external monitor, 4-91
- CSA mark definition, 10-5
- Current Size key, 8-20
- Custom Colors key, 8-20
- CW key, 8-20
- Cx notation, 7-17
- D**
- Data and Memory key, 8-21
- Data key, 8-21
- Data on OFF key, 8-21
- data storage, 11-13
- data traces, storing to memory, 4-55
- Data/Mem key, 8-21
- Data>Mem key, 8-21
- date, 4-50
- date, format, 8-17
- DD-MM-YYYY HH
 - MM key, 8-21
- declaration of conformity, 10-6
- Default 1-Port key, 8-22
- Default 2 key, 4-89, 8-22
- Default 2-Port key, 8-22
- default conditions, presetting the analyzer, 2-5
- Default key, 8-22
- default one-port calibration, 6-19, 8-22
- Default Pen Colors key, 8-23
- default response calibration, 6-15, 8-24
- Default Response key, 8-24
- default two-port calibration, 6-16, 6-20, 8-22
- Define Graph key, 8-23
- Define Hardcopy key, 8-23
- Define PCL5 key, 8-23
- Define Plotter key, 8-23
- Define Printer key, 8-23
- Define Save key, 8-24
- defining a printing device, 4-75
- defining what you save, 4-60
- definitions, specifications, 9-2
- delay
 - aperture, 3-70
 - electrical
 - effect on measurements, 5-21
 - group, 3-70
 - phase-derived, 3-70
- Delay Aperture key, 8-24
- Delay key, 8-24
- delay, calibration standard characteristic, 8-24
- Delete All Files key, 8-24
- Delete All Limits key, 8-24
- Delete All Users key, 8-25
- Delete Char key, 8-25
- Delete File key, 8-25
- Delete Limit, 4-37
- Delete Limit key, 8-25
- Delete Line key, 8-25
- Delete Login User key, 8-25
- deleting files, 4-65
- deleting limit segments, 4-37
- delta amplitude limit test, 4-35
- delta frequency limit test, 4-35
- delta markers, 4-24
- Delta Mkr on OFF key, 4-24, 8-25
- detection
 - broadband, 3-6
 - narrowband, 3-6
- detection modes, 3-4, 3-6
- Detection Options key, 8-26
- detector

- "A", 3-4
- "B", 3-4
- "R", 3-4
- B*, 3-6
- connectors, 1-11
- R*, 3-6
- zeroing, 6-22
- detectors
 - external, 1-11, 7-13
 - internal, 3-4
- device measurement, 3-3
- Diagnostic Utilities key, 8-26
- Directory Utilities key, 8-26
- directory, to make or change, 4-67
- disk
 - accessing files from, 4-66
 - dynamic data, 4-66
 - formatting, 4-69
 - internal 3.5", 4-66
 - memory recall, 4-62
 - MS-DOS formatting, 4-69
 - non-volatile RAM, 4-66
 - selecting, 4-59
 - volatile RAM, 4-66
- disk storage capacity, 11-13
- Disp Freq Resolution key, 8-26
- display, 7-16
 - annotation, modifying, 4-48
 - color, 4-89
 - customization, 4-45, 4-47
 - expanded, 4-52
 - features, 4-47
 - intensity control, 7-20
 - split, 4-46
- DISPLAY key, 8-26
- Display User List key, 8-26
- Distance key, 8-27
- Dither key, 8-27
- dithering, 5-13
- DOS formatted disks, 4-69
- downloading calibration kit standards, 6-31
- drift compensation, detectors, 6-22
- DTR/DSR key, 8-27
- dual channel measurements, 2-8
- dynamic range
 - changing measurement averaging, 5-11
 - changing system bandwidth, 5-10
 - factors, 5-9
 - increasing, 5-9
 - receiver input power, 5-9
 - reducing receiver floor, 5-10
- E**
- Edit key, 8-28
- edit limit example, 4-29
- Edit limit key, 8-28
- Edit Limit Min/Max key, 8-28
- electrical delay, 5-20
 - effect on measurements, 5-21
- Electrical Delay key, 8-28
- electrical requirements, 1-4
- electrostatic
 - discharge, 1-8
 - precautions, 1-8
- eliminating receiver spurious responses, 5-13
- End Frequency key, 8-28
- End Limit key, 8-29
- End Line # key, 8-29
- enhanced response calibration, 3-42, 6-17, 8-29
- Enhanced Response key, 8-29
- Enter Line 1 key, 8-29
- Enter Line 2 key, 8-29
- entering parameters, 2-4
- environmental requirements, 1-4
- Epson printers, 4-74
- error, unrecoverable (message), 8-66
- errors
 - frequency response, 6-4
 - leakage, 6-4
 - measurement, 6-3
 - mismatch, 6-4
 - systematic, 6-3
- ESD precautions, 1-8
- Ethernet Address key, 8-30
- Expand on OFF key, 8-30
- expanded display, 4-52
- explanation of S-parameter measurements, 3-10
- EXT REF IN, 7-4
- Ext Ref on OFF key, 8-30
- EXT TRIG IN/OUT, 7-4
- extensions, port, 5-18
- external auxiliary input (AUX INPUT), 3-68, 7-4
- external detector connectors, 1-11, 7-13
- external monitor, 4-89
- external monitor connector, 7-12
- external reference input, 7-4
- external trigger input, 7-4
- F**
- Factory Default key, 4-89, 8-31
- factory preset, 2-5
- factory preset conditions, 11-2
- Factory Preset key, 8-31
- FAIL! indicator, 4-29, 4-37, 4-51
- FastRecall on OFF key, 8-31
- Fault Loc Frequency key, 8-31
- Fault Location key, 8-31
- Fault Window key, 8-31
- features, specifications, 9-46
- file
 - format, 4-60
 - renaming, 4-65
 - saving, 4-59
 - to delete, 4-65
 - to rename, 4-65

- File Format, 11-12
- File Format key, 8-32
- File Type bin ASCII key, 8-32
- File Utilities key, 8-32
- Filter key, 8-32
- filter, multi-pole, 4-14
- Fine 15 Hz key, 8-33
- fine bandwidth, 5-10
- flat limit lines, 4-29
- flatness, 4-20
- Flatness key, 8-33
- flatness, marker limit test, 4-34
- floppy disk, 4-59
 - formatting, 4-69
- Format 3.5" Disk key, 8-33
- Format Disk Menu key, 8-33
- Format key, 8-33
- format markers
 - polar, 4-27
 - Smith, 4-27
- Format NonVol RAM key, 8-33
- Format Vol RAM key, 8-34
- format, file, 4-60
- Freq Annot ON off, 4-51
- FREQ key, 8-34
- Frequency Annot ON off key, 8-34
 - frequency annotation, 4-51
 - frequency change to increase sweep speed, 5-4
- Frequency key, 8-34
- frequency range
 - entering, 2-6
- frequency response errors, 6-4, 8-24, 8-73
- frequency shift
 - due to long electrical delay, 5-21
 - how to minimize, 5-21
- frequency tracking, 4-44
- frequency, delta marker limit, 4-35
- frequency, of data point, 4-39
- front and rear panel connectors, 7-2
- front and rear panel features, 7-2, 7-25
- front panel
 - display, 7-16
 - features, 7-2
 - knob, 7-18
 - tour, 2-3
- FTP key, 8-34
- FTP Password key, 8-35
- FTP User Name key, 8-35
- Full key, 8-35
- fuse
 - line, 1-4, 7-24
 - part number, 7-24
- G**
- Gateway IP Address key, 8-36
- general information, specifications, 9-40
- GPIB
 - addresses, 1-14
 - cables, 4-71
 - connector, 7-7
 - extender instruments, 7-8
 - interconnections, 1-12, 7-7
 - interface capabilities, 7-8
 - plotter address, 1-14
 - port, 1-11
 - printer address, 1-14
 - restrictions, 7-7
- GPIB Dev. Address key, 8-36
- GPIB Echo on OFF key, 8-36
- GPIB key, 8-36
- GPIB Log. Unit key, 8-36
- GPIB Name key, 8-36
- Graph and Mkr Table key, 8-37
- Graph Only key, 8-37
- Graphics Pen key, 8-37
- graticule, 4-47
- Graticule ON off key, 4-47, 8-37
- Graticule Pen key, 8-38
- Grey Scale key, 8-38
- group delay, 3-70
- Group ID key, 8-38
- H**
- hardcopy
 - typical times, 4-84
- Hardcopy All key, 8-39
- HARDCOPY key, 8-39
- hardcopy port configuration, 4-73
- Hardcopy Screen key, 8-39
- hardcopy speed, 4-84
- Help Message key, 8-39
- Hold key, 8-39
- horizontal back porch, 4-91
- Horizontal Back Porch key, 8-40
- Horizontal Frnt Porch key, 8-40
- horizontal front porch, 4-91
- Horizontal Position key, 8-40
- how to
 - create flat limit lines, 4-29
 - create single point limits, 4-32
 - delete limit segments, 4-37
 - use delta markers, 4-24
 - use limit lines, 4-28
 - use polar format markers, 4-27
 - use Smith chart markers, 4-27
- HP 7440A ColorPro Eight-Pen Color Graphics Plotter, 4-70
- HP 7470A Two-Pen Graphics Plotter, 4-70
- HP 7475A Six-Pen Graphics Plotter, 4-70
- HP 7550A/B High-Speed Eight-Pen Graphics Plotter, 4-70
- HP-IB
 - cable length, 1-14
- Hue key, 8-40
- Hz key, 8-41

- I**
- IBASIC display key, 8-42
 - IBASIC key, 8-42
 - icon
 - fail indicator, 4-38, 4-51
 - measurement display, 3-8
 - Imaginary key, 8-42
 - impedance magnitude, 3-81
 - Impedance Magnitude key, 8-42
 - impedance matching errors
 - how to reduce, 5-15
 - impedance measurement,
 - calibration example, 3-75
 - impedance, system, 3-13
 - incident signal, 3-3
 - increasing
 - dynamic range, 5-9
 - receiver input power, 5-9
 - start frequency, 5-4
 - increasing sweep speed, 5-3
 - indicator, averaging, 5-11
 - information saved, 4-57
 - initializing a disk, 4-69
 - input
 - auxiliary, 3-68, 7-4
 - external reference, 7-4
 - external trigger, 7-4
 - Insert Char key, 8-42
 - Insert Line key, 8-43
 - insertable devices, calibrating
 - for, 3-22
 - insertion loss, 3-47
 - Inst State ON off key, 8-43
 - Install CC From Disk key, 8-43
 - installation category, 1-5
 - installing
 - the analyzer, 1-2
 - the rack, 1-16
 - instruction manual symbol
 - defined, 10-5
 - Instrument Info key, 8-43
 - instrument markings and symbols, 10-5
 - instrument state settings,
 - saving, 4-57
 - instrument states
 - recalling, 4-57
 - Int Disp Intensity key, 8-43
 - intensity control, 7-20
 - interface
 - cables, 4-71
 - interface capabilities
 - GPIO, 7-8
 - Internal 3.5" Disk key, 8-44
 - internal detectors, 3-4
 - internal disk, 4-59
 - Internal key, 8-43
 - interpolation
 - reflection calibration, 6-22
 - transmission calibration, 6-18
 - introduction
 - front panel, 2-3
 - Inverse Video key, 8-44
 - IP Address to Ping, 11-12
 - IP Address to Ping key, 8-44
 - ISM1-A mark definition, 10-5
 - isolation calibration, 8-44, 8-73
 - Isolation on OFF key, 6-5, 6-16, 6-17, 6-20, 6-21, 8-44
- K**
- Key Record on OFF key, 8-45
 - keyboard connector, 1-11, 4-85, 7-13
 - keyboards
 - to connect, 4-85
 - using, 4-85
 - kHz key, 8-45
 - kits, calibration. *See* calibration kit.
 - knob, 7-18
- L**
- LAN key, 8-46
 - LAN port, 4-73
 - LAN Port Setup key, 8-46
 - LAN Printr IP Address key, 8-46
 - LAN State ON off key, 8-46
 - Landscape key, 8-46
 - leakage errors, 6-4
 - level
 - power, 2-6
 - reference, 2-6
 - Level key, 8-47
 - limit icon
 - explanation, 4-51
 - X Position, 4-37
 - Y Position, 4-37
 - Limit Icon ON off key, 8-47
 - limit indicator, 4-38
 - Limit key, 8-47
 - Limit Line ON off key, 4-37, 4-47
 - limit lines, 4-47
 - stimulus and amplitude values, 4-39
 - limit lines testing, 4-28
 - limit pass/fail indicator, 4-37, 4-51
 - limit test output, 7-5
 - LIMIT TEST TTL IN/OUT, 7-5
 - LIMIT TEST TTL IN/OUT connector, 4-28
 - limit testing
 - creating flat limit lines, 4-29
 - creating single point limits, 4-32
 - deleting limit segments, 4-37
 - flatness, 4-34
 - using markers, 4-32
 - Limit Text ON off key, 8-48
 - limit, edit example, 4-29
 - limit, marker, 4-32
 - limits and reference tracking, 4-36, 4-42
 - Lin Mag key, 8-48
 - line fuse
 - location, 7-24
 - ratings, 10-3
-

Index

- type, 1-4
- module, 7-22
- power requirements, 1-5, 7-25
- voltage requirements, 1-4
- voltage selector, 7-25
- voltage selector switch, 1-4
- List Trace Values key, 8-49
- Load CC From Disk key, 8-49
- Load key, 8-49
- load, calibration standard, 6-26
- Local Path key, 8-50, 8-71
- lock-up
 - how to fix, 8-66
 - system, 8-66
- Log Mag key, 8-50
- Login User Setup key, 8-50
- Loss key, 8-50
- loss, calibration standard
 - characteristic, 8-50
- loss, conversion, 3-62
- Lotus 123 ASCII file format, 4-61
- Lotus 123 Format key, 8-51
- Lower key, 8-51
- Luminance key, 8-51

M

- Mag Units key, 8-52
- magnitude, impedance, 3-81
- maintenance, preventive, 1-17
- make and change directories, 4-67
- Make Directory key, 8-52
- Manual Zero key, 8-52
- Marker > Center key, 8-52
- Marker > Elec Delay key, 8-53
- Marker > Reference key, 8-53
- marker flatness search, 4-20
- Marker Functions key, 8-53
- MARKER key, 8-52
- Marker key, 8-52
- marker limit, 4-32

- marker limit test
 - delta amplitude, 4-35
 - delta frequency, 4-35
 - flatness, 4-34
 - peak-to-peak ripple, 4-33
 - statistical mean, 4-33
- marker math, 4-18
- Marker Math key, 8-53
- marker number annotation, 4-51
- marker search, 4-7
 - max search, 4-7
 - min search, 4-7
 - next peak left, 4-8
 - next peak right, 4-8
 - RF filter, 4-22
 - sweep time, 5-7
 - tracking function, 4-7
- Marker Search key, 8-53
- marker statistics, 4-18
- marker tracking and sweep time, 5-7
- markers
 - polar format, 4-27
 - reference, 4-24
 - relative mode, 4-24
 - search
 - bandwidth values, 4-10
 - notch values, 4-13
 - Smith chart markers, 4-27
 - use with limit lines, 4-38
- markers and reference tracking, 4-42
- markers and sweep time, 5-7
- math, marker, 4-18
- Max Limit key, 8-54
- max search, 4-7
- Max Search key, 8-54
- mean, statistical, 4-18, 4-33
- MEAS 1 key, 8-54
- MEAS 2 key, 8-54
- Meas Annot ON off key, 8-54
- Measure Standard key, 8-54
- measurement

- absolute output power, 3-57
- annotation, 4-51
- averaging, 5-11
- broadband power, 3-57
- channel, 2-7
- channel annotation, 4-51
- choosing a calibration, 6-8
- detection modes, 3-6
- display icon, 3-8
- errors, 6-3
- group delay, 3-70
- impedance, 3-74
- impedance magnitude, 3-81
- narrowband power, 3-57
- optimizing, 5-2
- phase-derived delay, 3-70
- port 1 reflection, 8-75
- port 2 reflection, 8-76
- S₁₁, 3-49, 8-75
- S₁₂, 8-75
- S₂₁, 3-42, 8-75
- S₂₂, 3-49, 8-76
- saving data, 4-57
- S-parameters, 3-21
- speed with hardcopy, 4-84
- steps, 3-14
- theory, 3-3, 3-13
- typical sequence, 3-14
- using limit lines, 4-28
- using the BEGIN key, 3-15
- measuring devices, 3-3
- Med Narrow 1200 Hz key, 8-55
- Med Wide 4000 Hz key, 8-55
- Medium 3700 Hz key, 8-55
- medium bandwidth, 5-10
- medium narrow bandwidth, 5-10
- medium wide bandwidth, 5-10
- Memory 1 Pen key, 8-55
- Memory 2 Pen key, 8-55
- memory allocations, changing, 4-59
- Memory key, 8-55
- memory or disk recall, 4-62

memory traces, 4-55
MENU key, 8-55
MHz key, 8-56
Min Limit key, 8-56
min search, 4-7
Min Search key, 8-56
mismatch errors, 6-4
 how to reduce, 5-15
Mixer key, 8-56
Mkr > Max key, 8-57
Mkr > Min key, 8-58
Mkr Annot ON off key, 8-56
Mkr Limit on OFF key, 8-57
Mkr Limits, 4-32
Mkr Limits key, 8-57
Mkr Number ON off key, 8-57
Mkr Symbol ON off key, 8-57
Mkr Table Only key, 8-57
MM-DD-YYYY-HH
 MM key, 8-58
Mod Kit SaveRecall key, 8-58
Modify (connector type) key, 8-58
modify calibration kit, 8-58
 DUT has different connector types, 3-36
 DUT has same connector types, 3-30
Modify Size key, 8-58
monitor
 adjustments, 4-91
 external, 4-89, 7-12
 synchronization, 4-91
Monochrome key, 8-58
Monochrome Pen key, 8-59
Mount NFS key, 8-59
MS-DOS formatting, 4-69
Multi Notch key, 8-59
Multi Peak key, 8-59
multi-notch marker search, 4-14
multi-peak marker search, 4-14
multi-pin connectors, 7-7, 7-14
Multiport on OFF key, 8-59

N

Narrow 250 Hz key, 8-60
narrow bandwidth, 5-10
narrowband detection mode, 3-6
Narrowband Internal key, 8-60
narrowband power
 measurement, 3-57
Next Min Left key, 8-60
next min left marker search, 4-8
Next Min Right key, 8-60
next min right marker search, 4-8
Next Peak Left key, 8-61
next peak left marker search, 4-8
Next Peak Right key, 8-61
next peak right marker search, 4-8
NFS Device key, 8-61
NFS Device Setup key, 8-60, 8-61
NFS Device Table key, 8-61
noise floor reduction, 5-10
noise, trace
 activating averaging, 5-12
 changing system bandwidth, 5-12
 eliminating receiver spurious responses, 5-13
 reduction, 5-12
None key, 8-62
noninsertable devices,
 calibrating for, 3-26
Non-Vol RAM Disk key, 8-61
non-volatile memory
 battery powered, 11-13
normalization calibration, 6-14
normalize, 6-14
Normalize key, 8-62
notch, 4-13
Notch key, 8-62
Number of Points key, 8-62
numbering convention for S-parameters, 3-10

Numeric key, 8-62

O

one-port calibration. *See*
 calibration, user one-port
Open key, 8-63
open, calibration standard, 6-26,
 8-63
Operating Parameters key, 8-63
operational check, 2-10
operator's check, 2-10
operator's check, failure, 2-10
optimizing measurements, 5-2
Optional Boot Host key, 8-63
Optional File Name key, 8-63

P

page protection, 4-76
panel
 front and rear, 7-25
panel, front and rear, 7-2
parallel port, 1-11, 4-73, 4-74
Parameters Received key, 8-64
part number
 rack kit, 1-16
 static-safe equipment, 1-8
parts supplied with shipment, 1-3
pass/fail indicator, 4-37, 4-38, 4-51
Password key, 8-64
Path FWD rev key, 8-64
PCL5 setup, 4-75
peak tracking, 4-43
peak-to-peak ripple, marker
 limit test, 4-33
Perform Ping key, 8-64
Perform Secure key, 8-64
peripherals, connecting, 1-11
Phase key, 8-64
Phase Offset key, 8-65
phase-derived delay, 3-70

Index

- plane, calibration reference, 6-7
 - plotter
 - HP 7440A ColorPro Eight-Pen Color Graphics, 4-70
 - HP 7470A Two-Pen Graphics, 4-70
 - HP 7475A Six-Pen Graphics, 4-70
 - HP 7550A/B High-Speed Eight-Pen Graphics, 4-70
 - plotter address, 1-14
 - point limit creation, 4-32
 - point, frequency calculation, 4-39
 - points reduction, 5-5
 - polar format markers, 4-27
 - Polar key, 8-65
 - pollution degree rating, 1-5
 - port
 - GPIB, 1-11
 - LAN, 4-73
 - LIMIT TEST TTL IN/OUT, 4-28
 - parallel, 1-11, 4-73, 4-74
 - RS-232, 1-11
 - serial, 1-11, 4-73, 4-74
 - USER TTL IN/OUT, 4-64
 - Port 1 Extension key, 8-65, 8-92
 - Port 2 Extension key, 8-65, 8-92
 - port configuration for hardcopy, 4-73
 - Port Ext's on OFF key, 8-65
 - port extensions, 5-18
 - Portrait key, 8-65
 - position, reference, 2-6, 4-43
 - power
 - absolute, 3-57, 3-60
 - broadband, 3-57
 - narrowband, 3-57
 - probe, 7-14
 - power cable configurations, 7-22
 - POWER key, 8-66
 - Power key, 8-66
 - power level
 - entering, 2-6
 - preset, 2-6
 - power module, 7-22
 - power requirements, 1-5, 7-25
 - Power Sweep key, 8-66
 - power switch, 7-19
 - precautions, electrostatic, 1-8
 - preset
 - conditions, 2-5
 - factory, 2-5, 11-2
 - power level, 2-6
 - user-defined, 2-5
 - Preset (Factory) key, 8-31
 - Preset (User) key, 8-96
 - Preset All User Kits key, 8-67
 - preset conditions, 11-2
 - PRESET key, 8-66
 - preset power level, 2-6
 - Preset User Kit key, 8-67
 - preset, how calibration is affected, 6-13
 - preventive maintenance, 1-17
 - print overrun error, 4-76
 - print times, 4-84
 - Print Width key, 8-67
 - Print/Plot GPIB Addr key, 8-67
 - printer address, 1-14
 - printer compatibility guide, 4-70
 - Printer Resolution key, 8-68
 - printing and plotting, 4-80
 - baud rate, 4-74
 - printing device definition, 4-75
 - printing speed, 4-84
 - probe power, 7-14
 - procedure
 - creating flat limit lines, 4-29
 - creating single point limits, 4-32
 - deleting limiting segments, 4-37
 - increasing dynamic range, 5-9
 - increasing sweep speed, 5-3
 - setting sweep to auto mode, 5-4
 - testing with limit lines, 4-28
 - turning off alternate sweep, 5-7
 - using delta markers, 4-24
 - using polar format markers, 4-27
 - widening system bandwidth, 5-4
 - Programs key, 8-68
 - Pwr Level at Preset key, 8-68
 - Pwr Sweep Range key, 8-68
- ## R
- R detector, 3-4
 - R key, 8-69
 - R* detector, 3-6
 - R* key, 8-69
 - rack
 - installation, 1-16
 - part number, 1-16
 - range, frequency, 2-6
 - Real key, 8-69
 - rear panel features, 7-2, 7-25
 - recall from a disk or memory, 4-62
 - Recall Program key, 8-70
 - Recall State key, 8-70
 - recalling measurements, 4-57
 - receiver input damage level, 5-9
 - receiver input power increase, 5-9
 - receiver inputs, 3-4
 - receiver noise
 - dithering, 5-13
 - spur avoidance, 5-13
 - receiver noise floor reduction, 5-10
 - reducing mismatch errors, 5-15
 - reducing number of measurement points, 5-5

Index

- reducing receiver noise floor, 5-10
- reducing the amount of
 - averaging, 5-5
- reducing trace noise, 5-12
- Reference Level key, 2-6, 8-70
- reference markers, 4-24
- reference plane adjustment, 5-18
- reference plane, calibration, 6-7
- reference position, 4-43
- Reference Position key, 2-6, 8-70
- reference signal, 3-4
- reference signal, external, 7-4
- reference tracking, 4-44
 - using limits with, 4-36, 4-42
 - using markers with, 4-42
- Reference Tracking key, 8-70
- reflection
 - calibration, 6-19
 - calibration interpolation, 6-22
 - formula, 3-55
 - measurements, 8-75, 8-76
- Reflection key, 8-70
- relative marker mode, 4-24
- Remote IP Addr/Host key, 8-71
- remote path host, 8-72
- Remove Automount key, 8-72
- Remove Directory key, 8-72
- Remove Pattern key, 8-72
- Rename File key, 8-72
- renaming a file, 4-65
- requirements, electrical and environmental, 1-4
- Re-Save Program key, 8-69
- Re-Save State key, 8-69
- Response & Isolation key, 8-73
- response and isolation
 - calibration, 6-17
- response calibration, 6-16, 8-73
- response errors, frequency, 6-4
- Response key, 8-73
- Restart Average key, 8-73
- Restore Defaults key, 8-74
- restrictions
 - GPIB, 7-7
- retrieving previous calibrations, 6-12
- return loss, 3-56
- RF connectors, 7-15
- RF Filter Stats, 4-22
- RF Filter Stats key, 8-74
- RF ON off key, 8-74
- RF power out, setting, 2-6
- ripple, marker limit test, 4-33
- Round Seconds key, 8-74
- rpg knob, 7-18
- RS-232 (serial) port, 1-11, 4-73, 4-74, 7-11
- Run key, 8-74
- S**
- S₁₁
 - calibration, 3-50, 6-19
 - measurement, 3-49
- S₁₁ Refl Port 1 key, 8-75
- S₁₂
 - calibration, 6-15
 - measurement, 3-42
- S₁₂ Rev Trans key, 8-75
- S₂₁
 - calibration, 6-15
 - measurement, 3-42
- S₂₁ Fwd Trans key, 8-75
- S₂₂
 - calibration, 3-50, 6-19
 - measurement, 3-49
- S₂₂ Refl Port 2 key, 8-76
- S2P ASCII file format, 4-61
- safety information, 10-3
- safety warnings, 10-3
- sales and service offices, Agilent Technologies, 9-58
- Saturation key, 8-76
- Save AUTOST key, 8-76
- save definition, 4-60
- Save Meas 1 key, 8-77
- Save Meas 2 key, 8-77
- Save Program key, 8-77
- SAVE RECALL key, 8-77
- Save State key, 8-77
- saving a calibration, 4-60, 6-33
- saving and recalling
 - measurement results, 4-57
- saving data, 4-59
- SCALE key, 8-77
- Scale/Div key, 8-78
- screen annotation, 8-9
- search left, 4-10
- Search Left key, 8-78
- Search Off key, 8-78
- search right, 4-10
- Search Right key, 8-78
- search, marker, 4-7
- Seconds ON off key, 8-78
- Secure key, 8-79
- segment deleting, 4-37
- Select Char key, 8-79
- Select Char/Word key, 8-79
- Select Copy Port key, 8-79
- select disk, 4-59
- Select Disk key, 8-79
- Select Item key, 8-80
- Select key, 8-79
- selecting the disk, 4-59
- selector switch
 - voltage, 7-25
- serial port, 1-11, 4-73, 4-74, 7-11
- Service key, 8-80
- Service Utilities key, 8-80
- Set Clock key, 8-80
- Set Day key, 8-80
- Set Hour key, 8-80
- Set Minute key, 8-80
- Set Month key, 8-81
- Set Pen Numbers key, 8-81
- Set Track Frequency, 4-44
- Set Track Frequency key, 8-81

Index

- Set Year key, 8-81
- setting GPIB addresses, 1-14
- setting the line voltage, 1-4
- setting up the analyzer, 1-10
- shift spurs, 5-13
- shipment contents, 1-3
- shipping instructions, 10-4
- Short key, 8-81
- short, calibration standard, 6-26, 8-81
- Show Clock on Line 1 key, 8-82
- Show Clock on Line 2 key, 8-82
- SICL LAN Setup key, 8-82
- signal detection, 3-6
- signal path icon, 3-8
- Single key, 8-82
- single point limits, 4-32
- Smith Chart key, 8-82
- Smith chart markers, 4-27
- Smith Chart Z0 key, 8-82
- Socket Port No. key, 8-82
- softkey auto-step, 4-64
- Softkey Auto-Step key, 8-83
- source power, entering, 2-6
- Space key, 8-83
- Span key, 2-6, 8-83
- S-parameter measurements, calibration example, 3-21
- S-parameters
 - explanation, 3-10
 - measuring, 3-10
 - numbering convention, 3-10
- specifications, 9-1, 9-2
 - definitions, 9-2
 - features, 9-46
 - general information, 9-40
 - system performance, corrected,
 - 50 ohm
 - 2-port cal, 9-4
 - T/R cal, 9-10
 - system performance, corrected,
 - 75 ohm
 - 2-port cal, 9-8
 - T/R cal, 9-16
 - system performance,
 - uncorrected
 - 50 ohm, 9-22
 - 75 ohm, 9-23
 - test port input, 9-30
 - test port output, 9-24
 - speed increase of sweep, 5-3
 - speed with hardcopy, 4-84
 - Split Disp FULL split key, 8-83
 - split display, 2-8, 4-46
 - Spur Avoid key, 8-83
 - Spur Avoid Options key, 8-84
 - spur avoidance, 5-8, 5-13
 - SRL key, 8-84
 - Stack Size key, 8-84
 - standard deviation, 4-18
 - standards, calibration, 6-26
 - standby, 7-19
 - start frequency, change to increase sweep speed, 5-4
 - Start key, 2-6, 8-84
 - Start Line # key, 8-84
 - Start Power key, 8-84
 - static-safe equipment
 - part numbers, 1-8
 - statistical mean, marker limit test, 4-33
 - Statistics key, 8-85
 - statistics, marker, 4-18
 - statistics, peak-to-peak, 4-33
 - Step key, 8-85
 - Step Sweep on OFF key, 8-85
 - Stop key, 2-6, 8-85
 - Stop Power key, 8-85
 - stop printer, 8-6
 - Store CC To Disk key, 8-85
 - Store CC To EPROM key, 8-86
 - storing measurement results, 4-57
 - Subnet Mask key, 8-86
 - swap equal adapters method of calibration, 3-26
 - SWEEP key, 8-86
 - Sweep Out key, 8-86
 - sweep speed
 - increase start frequency, 5-4
 - increasing, 5-3
 - reducing averaging, 5-5
 - reducing number of points, 5-5
 - turning off alternate sweep, 5-7
 - turning off spur avoidance, 5-8
 - using auto mode, 5-4
 - viewing single measurement channel, 5-6
 - Sweep Time AUTO man key, 8-86
 - Sweep Time key, 8-86
 - switch
 - line voltage selector, 1-4
 - power, 7-19
 - Switching Test Set key, 8-87
 - SWR key, 8-87
 - symbol, instruction manual, 10-5
 - symbols and markings
 - instrument, 10-5
 - Sync Green on OFF key, 8-87
 - synchronization of external monitor, 4-91
 - sync-on-green capability, 4-91
 - system bandwidth, 5-10
 - changing, 5-12
 - how it works, 5-10
 - System Bandwidth key, 8-87
 - System Config key, 8-88
 - System Controller key, 8-88
 - system impedance, 3-13
 - system lock-up, how to recover, 8-66
 - SYSTEM OPTIONS key, 8-88
 - system performance,
 - specifications, 9-4
 - System Z0 key, 8-88
 - systematic errors, 6-3

T

Talker Listener key, 8-89
target search, 4-10
Target Search key, 8-89
Target Value, 4-10
Target Value key, 8-89
techniques for optimizing measurements, 5-2
ten error-term correction, 6-5
test pattern, 4-91
test port input, specifications, 9-30
test port output, specifications, 9-24
testing with limit lines, 4-28
Tests and Adjustments key, 8-89
TFTP key, 8-89
theory, measurement, 3-3
through, calibration standard, 6-26, 8-90
Thru key, 8-90
time, 4-50
time, format, 8-17
Timeout key, 8-90
Title and Clock key, 4-50
Title+Clk ON off key, 8-90
Top Margin key, 8-90
total cycle time, graph, 5-6
Touchstone ASCII file format, 4-61
Touchstone Format key, 8-90
Trace 1 Pen key, 8-91
Trace 2 Pen key, 8-91
Trace Data ON off key, 8-91
trace noise
 activating averaging, 5-12
 changing system bandwidth, 5-12
 eliminating receiver spurious responses, 5-13
 factors, 5-12
 reduction, 5-12
Track Frequency key, 8-91
Track Peak key, 8-91
track peak point, 4-43
tracking, 4-7
 frequency, 4-44
 peak, 4-43
Tracking on OFF key, 4-7, 8-92
tracking, marker, 5-7
transmission
 calibration, 6-15
 calibration interpolation, 6-18
 formula, 3-47
 measurements, 8-75
Transmissn key, 8-92
transporting instructions, 10-4
trigger
 external, 7-4
Trigger key, 8-92
Trigger Source key, 8-92
TSet Cal on OFF key, 8-93
twelve error-term correction, 6-5
two-port calibration. *See*
 calibration, user two-port
type-F cal kit, 8-93
Type-F key, 8-93
type-N(f) cal kit, 8-93
Type-N(f)(Default) key, 8-93
type-N(m) cal kit, 8-93
Type-N(m) key, 8-93
types of calibration, 6-10
types of calibration standards, 6-26

U

Unmount NFS Device key, 8-94
unpacking the analyzer, 1-3
unrecoverable-error message, 8-66
Update Corr Const key, 8-94
Upper key, 8-94
User 1-Port key, 8-94
User 2-Port key, 8-95
User BEGIN, 3-19

User BEGIN on OFF key, 8-95
User Cal Kit (A–J) key, 8-95
User ID key, 8-95
User Name key, 8-95
user one-port calibration, 3-50, 6-21, 8-94
user preset, 2-5
User Preset key, 8-96
user response calibration, 8-96
User Response key, 8-96
User TTL Config key, 8-96
USER TTL IN/OUT rear panel connector, 4-64, 7-6
user two-port calibration, 3-21, 3-23, 3-72, 3-75, 6-5, 6-17, 6-21, 8-95
user-defined calibration kit, 6-25
using memory traces, 4-55
Utilities key, 8-96

V

Velocity Factor key, 8-97
vertical back porch, 4-91
Vertical Back Porch key, 8-97
Vertical Frnt Porch key, 8-97
vertical front porch, 4-91
Vertical Position key, 8-98
vertical scale, how to set, 8-10
VGA monitor, 4-89, 7-12
VIDEO OUT COLOR VGA connector, 1-11, 7-12
viewing a single measurement channel, 5-6
Volatile RAM Disk key, 8-98
volatile settings, 11-12
voltage requirements, 1-5
voltage selector switch, 7-25

W

warning definition, 10-3
warranty, 9-56
Wide 6500 Hz key, 8-99

wide bandwidth, [5-10](#)

X

X key, [8-100](#)

X/Y key, [8-100](#)

x-axis annotation, [4-51](#)

Xon/Xoff key, [8-100](#)

Y

Y key, [8-101](#)

Y/R* key, [8-102](#)

Y/X key, [8-102](#)

y-axis annotation, [4-51](#)

Y-Axis Lbl ON off key, [8-101](#)

Y-Axis Lbl rel ABS key, [8-101](#)

YYYY-MM-DD HH

MM key, [8-102](#)

Z

Z0 key, [8-103](#)

Z0, calibration standard
characteristic, [8-103](#)

zeroing detectors, [6-22](#)