

Agilent De-embedding and Embedding S-Parameter Networks Using a Vector Network Analyzer

Application Note 1364-1

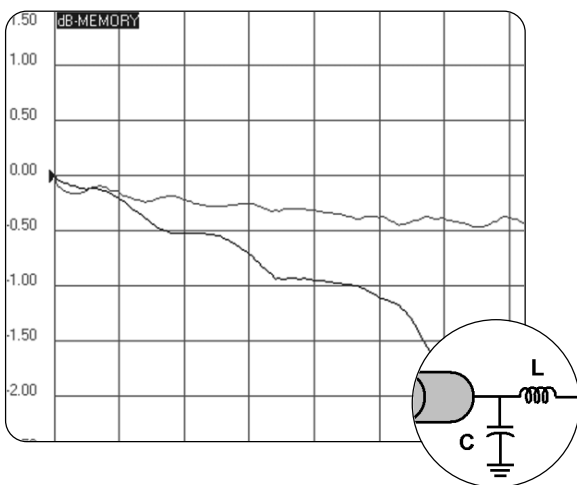
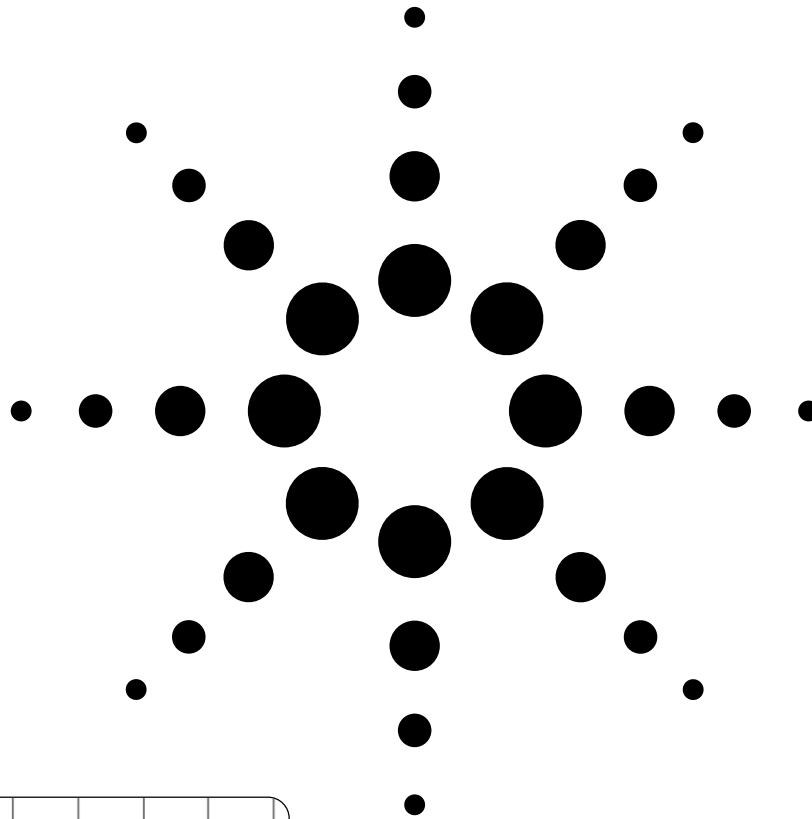

Introduction

Traditionally RF and microwave components have been designed in packages with coaxial interfaces. Complex systems can be easily manufactured by connecting a series of these separate coaxial devices. Measuring the performance of these components and systems is easily performed with standard test equipment that uses similar coaxial interfaces.

However, modern systems demand a higher level of component integration, lower power consumption, and reduced manufacturing cost. RF components are rapidly shifting away from designs that use expensive coaxial interfaces, and are moving toward designs that use printed circuit board and surface mount technologies (SMT). The traditional coaxial interface may even be eliminated from the final product. This leaves the designer with the problem of measuring the performance of these RF and microwave components with test equipment that requires coaxial interfaces. The solution is to use a test fixture that interfaces the coaxial and non-coaxial transmission lines.

The large variety of printed circuit transmission lines makes it difficult to create test equipment that can easily interface to all the different types and dimensions of microstrip and coplanar transmission lines¹ (Figure 1). The test equipment requires an interface to the selected transmission media through a test fixture.

Accurate characterization of the surface mount device under test (DUT) requires the test fixture characteristics to be removed from the measured results. The test equipment typically used for characterizing the RF and microwave component is the vector network analyzer (VNA) which uses standard 50 or 75 ohm coaxial interfaces at the test ports. The test equipment is calibrated at the coaxial interface defined as the “measurement plane,” and the required measurements are at the point where the surface-mount device attaches to the printed circuit board, or the “device plane” (Figure 2). When the VNA is calibrated at the coaxial interface using any standard calibration kit, the DUT measurements include the test fixture effects.

Over the years, many different approaches have been developed for removing the effects of the test fixture from the measurement, which fall into two fundamental categories: direct measurement and de-embedding. Direct measurement requires specialized calibration standards that are inserted into the test fixture and measured. The accuracy of the device measurement relies on the quality of these physical standards.² De-embedding uses a model of the test fixture and mathematically removes the fixture characteristics from the overall measurement. This fixture “de-embedding” procedure can produce very accurate results for the non-coaxial DUT, without complex non-coaxial calibration standards.

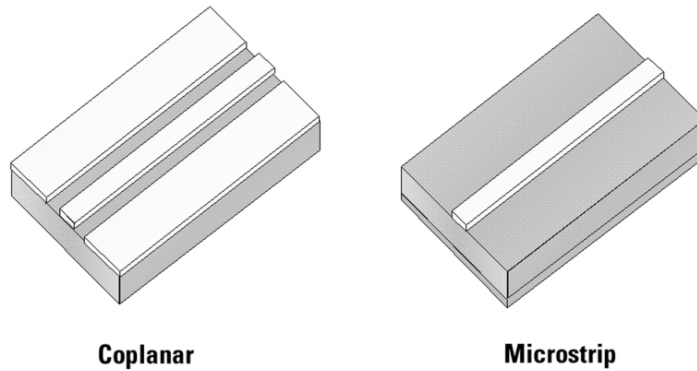

Figure 1. Types of printed circuit transmission lines

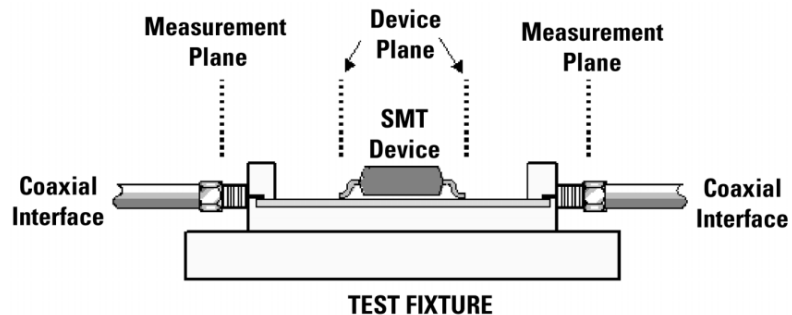

Figure 2. Test fixture configuration showing the measurement and device planes

The process of de-embedding a test fixture from the DUT measurement can be performed using scattering transfer parameters (T-parameter) matrices.³ For this case, the de-embedded measurements can be post-processed from the measurements made on the test fixture and DUT together. Also modern CAE tools such as Agilent EEsof Advanced Design System (ADS) have the ability to directly de-embed the test fixture from the VNA measurements using a negation component model in the simulation.³ Unfortunately these approaches do not allow for real-time feedback to the operator because the measured data needs to be captured and post-processed in order to remove the effects of the test fixture. If real-time de-embedded measurements are required, an alternate technique must be used.

It is possible to perform the de-embedding calculation directly on the VNA using a different calibration model. If we include the test fixture effects as part of the VNA calibration error coefficients, real time de-embedded measurements can be displayed directly on the VNA. This allows for real-time tuning of components without including the fixture as part of the measurement.

The following sections of this paper will review S-parameter matrices, signal flow graphs, and the error correction process used in standard one and two-port calibrations on all Agilent vector network analyzers such as the E8358A PNA Series Network Analyzer. The de-embedding process will then be detailed for removing the effects of a test fixture placed between the measurement and device planes. Also included will be a description on how the same process can be used to embed a hypothetical or “virtual” network into the measurement of the DUT.

S-parameters and signal flow graphs

RF and microwave networks are often characterized using scattering or S-parameters.⁴ The S-parameters of a network provide a clear physical interpretation of the transmission and reflection performance of the device. The S-parameters for a two-port network are defined using the reflected or emanating waves, b_1 and b_2 , as the dependent variables, and the incident waves, a_1 and a_2 , as the independent variables (Figure 3). The general equations for these waves as a function of the S-parameters is shown below:

$$\begin{aligned} b_1 &= S_{11}a_1 + S_{12}a_2 \\ b_2 &= S_{21}a_1 + S_{22}a_2 \end{aligned}$$

Using these equations, the individual S-parameters can be determined by taking the ratio of the reflected or transmitted wave to the incident wave with a perfect termination placed at the output. For example, to determine the reflection parameter from Port 1, defined as S_{11} , we take the ratio of the reflected wave, b_1 to the incident wave, a_1 , using a perfect termination on Port 2. The perfect termination guarantees that $a_2 = 0$ since there is no reflection from an ideal load. The remaining S-parameters, S_{21} , S_{22} and S_{12} , are defined in a similar manner.⁵ These four S-parameters completely define the two-port network characteristics. All modern vector network analyzers, such as the Agilent E8358A, can easily measure the S-parameters of a two-port device.

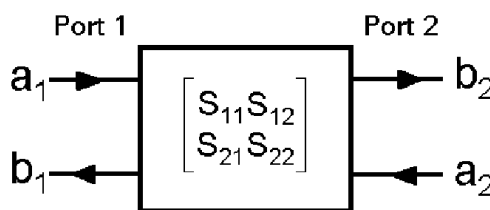

$$\begin{bmatrix} b_1 \\ b_2 \end{bmatrix} = \begin{bmatrix} S_{11} & S_{12} \\ S_{21} & S_{22} \end{bmatrix} \begin{bmatrix} a_1 \\ a_2 \end{bmatrix}$$

Figure 3. Definition of a two-port S-Parameter network

Another way to represent the S-parameters of any network is with a signal flow graph (Figure 4). A flow graph is used to represent and analyze the transmitted and reflected signals from a network. Directed lines in the flow graph represent the signal flow through the two-port device. For example, the signal flowing from node a_1 to b_1 is defined as the reflection from Port 1 or S_{11} . When two-port networks are cascaded, it can be shown that connecting the flow graphs of adjacent networks can be done because the outgoing waves from one network are the same as the incoming waves of the next.⁶ Analysis of the complete cascaded network can be accomplished using Mason’s Rule.⁶ It is the application of signal flow graphs that will be used to develop the mathematics behind network de-embedding and modifying the error coefficients in the VNA.

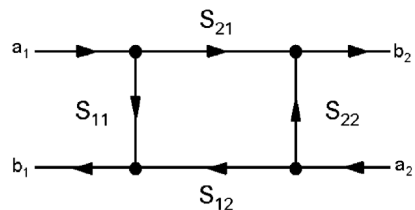

Figure 4. Signal flow graph representation of a two-port S-parameter network

Defining the test fixture and DUT

Before the mathematical process of de-embedding is developed, the test fixture and the DUT must be represented in a convenient form. Using signal flow graphs, the fixture and device can be represented as three separate two-port networks (Figure 5). In this way, the test fixture is divided in half to represent the coaxial to non-coaxial interfaces on each side of the DUT. The two fixture halves will be designated as Fixture A and Fixture B for the left-hand and right-hand sides of the fixture respectively. The S-parameters FA_{xx} ($xx = 11, 21, 12, 22$) will be used to represent the S-parameters for the left half of the test fixture and FB_{xx} will be used to represent the right half.

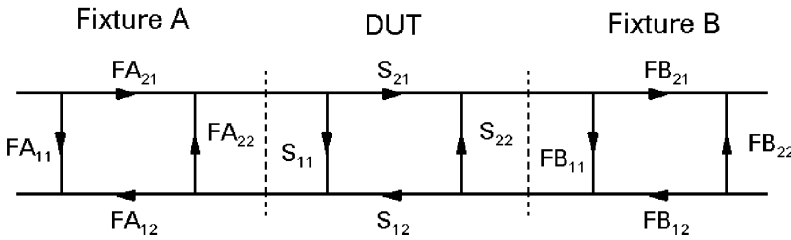

Figure 5. Signal flow graph representing the test fixture halves and the device under test (DUT)

If we wish to directly multiply the matrices of the three networks, we find it mathematically more convenient to convert the S-parameter matrices to scattering transfer matrices or T-parameters. The mathematical relationship between S-parameter and T-parameter matrices is given in Appendix A. The two-port T-parameter matrix can be represented as $[T]$, where $[T]$ is defined as having the four parameters of the network.

$$[T] = \begin{bmatrix} T_{11} & T_{12} \\ T_{21} & T_{22} \end{bmatrix}$$

Because we defined the test fixture and DUT as three cascaded networks, we can easily multiply their respective T-parameter networks, T_A , T_{DUT} and T_B . It is only through the use of T-parameters that this simple matrix equation be written in this form.

$$[T_{MEASURED}] = [T_A] [T_{DUT}] [T_B]$$

This matrix operation will represent the T-parameters of the test fixture and DUT when measured by the VNA at the measurement plane.

It is our goal to de-embed the two sides of the fixture, T_A and T_B , and gather the information from the DUT or T_{DUT} . Extending this matrix inversion to the case of the cascaded fixture and DUT matrices, we can multiply each side of the measured result by the inverse T-parameter matrix of the fixture and yield the T-parameter for the DUT only. The T-parameter matrix can then be converted back to the desired S-parameter matrix using the equations in Appendix A.

$$[T_A]^{-1} [T_A] [T_{DUT}] [T_B] [T_B]^{-1} = [T_{DUT}]$$

Using the S or T-parameter model of the test fixture and VNA measurements of the total combination of the fixture and DUT, we can apply the above matrix equation to de-embed the fixture from the measurement. The above process is typically implemented after the measurements are captured from the VNA. It is often desirable that the de-embedded measurements be displayed real-time on the VNA. This can be accomplished using techniques that provide some level of modification to the error coefficients used in the VNA calibration process.

General matrix theory states that if a matrix determinate is not equal to zero, then the matrix has an inverse, and any matrix multiplied by its inverse will result in the identity matrix. For example, if we multiply the following T-parameter matrix by its inverse matrix, we obtain the identity matrix.

$$[T] [T]^{-1} = \begin{bmatrix} 1 & 0 \\ 0 & 1 \end{bmatrix}$$

Test Fixture Models

Before we can mathematically de-embed the test fixture from the device measurements, the S or T-parameter network for each fixture half needs to be modeled. Because of the variety of printed circuit types and test fixture designs, there are no simple textbook formulations for creating an exact model. Looking at the whole process of de-embedding, the most difficult part is creating an accurate model of the test fixture. There are many techniques that can be used to aid in the creation of fixture models, including simulation tools such as Agilent Advanced Design System (ADS) and Agilent High Frequency Structure Simulator (HFSS). Often observation of the physical structure of the test fixture is required for the initial fixture model. Measurements made on the fixture can be used to optimize the fixture model in an iterative manner. Time domain techniques, available on most network analyzers, can also be very useful when optimizing the fixture model.²

Let's examine several fixture models that can be used in the de-embedding process. We will later show that some of the simpler models are used in the firmware of many vector network analyzers to directly perform the appropriate de-embedding without requiring the T-parameter matrix mathematics.

The simplest model assumes that the fixture halves consist of perfect transmission lines of known electrical length. For this case, we simply shift the measurement plane to the DUT plane by rotating the phase angle of the measured S-parameters (Figure 6). If we assume the phase angles, θ_A and θ_B , represent the phase of the right and left test fixture halves respectively, then the S-parameter model of the fixture can be represented by the following equations.

$$S_A = \begin{bmatrix} 0 & e^{-j\theta_A} \\ e^{-j\theta_A} & 0 \end{bmatrix}$$

$$S_B = \begin{bmatrix} 0 & e^{-j\theta_B} \\ e^{-j\theta_B} & 0 \end{bmatrix}$$

The phase angle is a function of the length of the fixture multiplied by the phase constant of the transmission line. The phase constant, β , is defined as the phase velocity divided by the frequency in radians. This simple model assumes that the fixture is a lossless transmission line that is matched to the characteristic impedance of the system. An easy way to calculate the S-parameter values for this ideal transmission line is to use a software simulator such as Agilent ADS. Here, each side of the test fixture can be modeled as a 50-ohm transmission line using the appropriate phase angle and reference frequency (Figure 7). Once the simulator calculates all the S-parameters for the circuit, the information can be saved to data file for use in the de-embedding process.

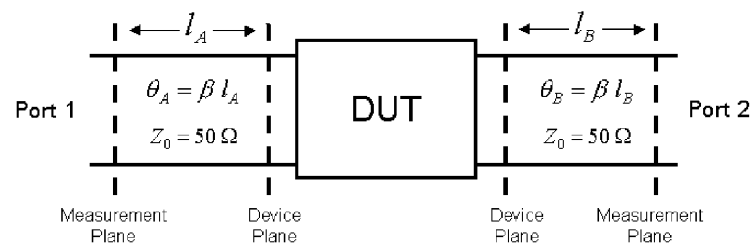

Figure 6. Modeling the fixture using an ideal transmission line

This model only accounts for the phase length between the measurement and device planes. In some cases, when the fixture is manufactured with low-loss dielectric materials and uses well-matched transitions from the coaxial to non-coaxial media, this model may provide acceptable measurement accuracy when performing de-embedding.

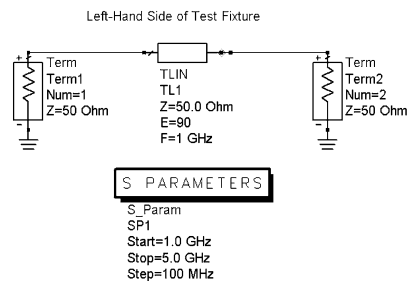

Figure 7. Agilent ADS model for the test fixture using an ideal two-port transmission line

An improved fixture model modifies the above case to include the insertion loss of the fixture. It can also include an arbitrary characteristic impedance, Z_A , or Z_B , of the non-coaxial transmission line (Figure 8). The insertion loss is a function of the transmission line characteristics and can include dielectric and conductor losses. This loss can be represented using the attenuation factor, α , or the loss tangent, $\tan\delta$.

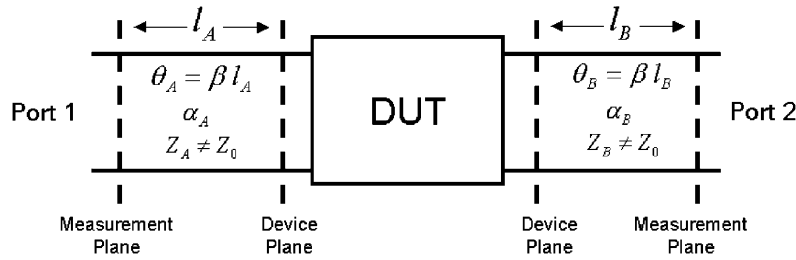

Figure 8. Modeling the fixture using a lossy transmission line

To improve the fixture model, it may be possible to determine the actual characteristic impedance of the test fixture's transmission lines, Z_A and Z_B , by measuring the physical characteristics of the fixture and calculating the impedance using the known dielectric constant for the material. If the dielectric constant is specified by the manufacturer with a nominal value and a large tolerance, then the actual line impedance may vary over a wide range. For this case, you can either make a best guess to the actual dielectric constant or use a measurement technique for determining the characteristic impedance of the line. One technique uses the time domain option on the vector network analyzer. By measuring the frequency response of the fixture using a straight section of transmission line, the analyzer will convert this measurement into a Time Domain Reflectometer (TDR) response that can be used to determine the impedance of the transmission line. Refer to the analyzer's User's Guide for more information.

Once again, a software simulator can be used to calculate the required S-parameters for this model. Figure 9 shows the model for the test fixture half using a lossy transmission line with the attenuation specified using the loss tangent. For this model, the line impedance was modified to a value of 48-ohms based on physical measurements of the transmission line width and dielectric thickness and using a nominal value for the dielectric constant.

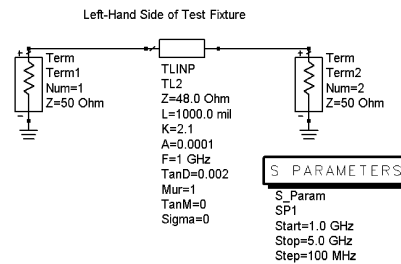

Figure 9. Agilent ADS model for the test fixture using a lossy two-port transmission line

We will later find that many vector network analyzers, such as the Agilent E8358A, can easily implement this model by allowing the user to enter the loss, electrical delay and characteristic impedance directly into the analyzers "calibration thru" definition.

The last model we will discuss includes the complex effects of the coax-to-non-coaxial transitions as well as the fixture losses and impedance differences we previously discussed. While this model can be the most accurate, it is the hardest one to create because we need to include all of the non-linear effects such as dispersion, radiation and coupling that can occur in the fixture. One way to determine the model is by using a combination of measurements of known devices placed in the fixture (which can be as simple as a straight piece of transmission line) and a computer model whose values are optimized to the measurements. A more rigorous approach uses an electromagnetic (EM) simulator, such as Agilent HFSS, to calculate the S-parameters of the test fixture. The EM approach can be very accurate as long as the physical test fixture characteristics are modeled correctly in the simulator.

As an example, we will show a model created by optimizing a computer simulation based on a series of measurements made using the actual test fixture. We begin by modeling a coax-to-microstrip transition as a lumped series inductance and shunt capacitance (Figure 10). The values for the inductance and capacitance will be optimized using the measured results from the straight 50-ohm microstrip line placed in the test fixture. An ADS model is then created for the test fixture and microstrip line using this lumped element model.

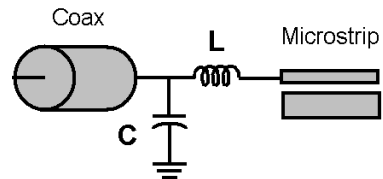

Figure 10. Simplified model of a coax to microstrip transition

The Agilent ADS model, shown in Figure 11, use the same lumped element components placed on each side to model the two test fixture transitions. A small length of coax is used to represent the coaxial section for each coax-to-microstrip connector. A microstrip thru line is placed in the center whose physical and electrical parameters match the line measured in the actual test fixture. This microstrip model requires an accurate value for dielectric constant and loss tangent for the substrate material used. Uncertainty in these values will directly affect the accuracy of the model.

S-parameters measurements are then made on the test fixture and the microstrip thru line using a vector network analyzer such as the Agilent E8358A. The four S-parameters can be directly imported into the ADS software over the GPIB. The model values for inductance and capacitance are optimized using ADS until a good fit is obtained between the measurements and the simulated results. As an example, Figure 12 shows the measured and optimized results for the magnitude of S11 using the test fixture with a microstrip thru line. All four S-parameters should be optimized

and compared to the measured S-parameters to verify the accuracy of the model values. Because of non-linear effects in the transition, this simplified lumped element model for the transition may only be valid only over a small frequency range. If broadband operation is required, an improved model must be implemented to incorporate the non-linear behavior of the measured S-parameters as a function of frequency.

Once the lumped element parameters are optimized, the S-parameters for each half of the test fixture can be simulated and saved for use by the de-embedding algorithm. Keep in mind that it is necessary to include the actual length of microstrip line between the transition and device when calculating the S-parameters for the test fixture halves.

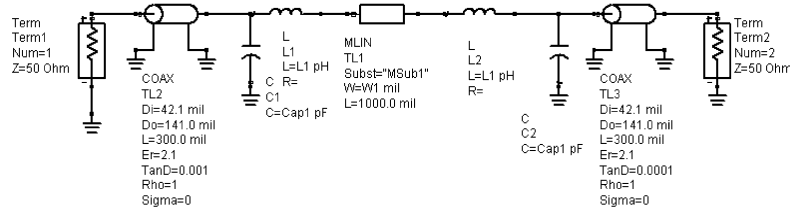

Figure 11. Agilent ADS model of test fixture and microstrip line

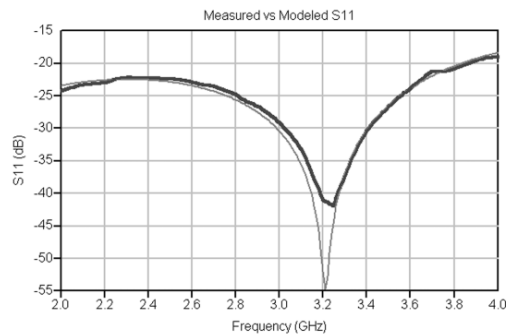

Figure 12. Comparison of S11 for the measured and modeled microstrip thru line

The de-embedding process

Whether a simplified model, such as a length of ideal transmission line, or a complex model, created using an EM simulator, is used for the test fixture, it is now necessary to perform the de-embedding process using this S-parameter model. There are two main ways the de-embedding process can be implemented. The first technique uses measured data from a network analyzer and processes the data using the T-parameter matrix calculations discussed in the previous section. The second technique uses the network analyzer to directly perform the de-embedding calculations, allowing the user to examine the de-embedding response in real-time. This technique is accomplished by modifying the calibration error terms in the analyzer's memory.

The Static Approach

This approach uses measured data from the test fixture and DUT gathered at the measurement plane. The data can be exported from the network analyzer or directly imported into a simulation tool, such as ADS, over the GPIB. Using the fixture model, the de-embedding process is performed using T-parameter matrix calculations or the negation model in ADS.³ Once the measurements are de-embedded, the data is displayed statically on a computer screen or can be downloaded into the analyzer's memory for display.

There are five steps for the process of de-embedding the test fixture using T-parameters:

Step 1: Create a mathematical model of the test fixture using S or T-parameters to represent each half of the fixture.

Step 2: Using a vector network analyzer, calibrate the analyzer using a standard coaxial calibration kit and measure the S-parameters of the device and fixture together. The S-parameters are represented as complex numbers.

Step 3: Convert the measured S-parameters to T-parameters.

Step 4: Using the T-parameter model of the test fixture, apply the de-embedding equation to the measured T-parameters.

$$\left[\mathbf{T}_{\text{DUT}} \right] = \left[\mathbf{T}_A \right]^{-1} \left[\mathbf{T}_M \right] \left[\mathbf{T}_B \right]^{-1}$$

Step 5: Convert the final T-parameters back to S-parameters and display the results. This matrix represents the S-parameters of the device only. The test fixture effects have been removed.

The Real-Time Approach

This real-time approach will be detailed in the following sections of this application note. For this technique, we wish to incorporate the test fixture S-parameter model into the calibration error terms in the vector network analyzer. In this way, the analyzer is performing all the de-embedding calculations, which allows the users to view real-time measurements of the DUT without the effects of the test fixture.

Most vector network analyzers are capable of performing some modification to the error terms directly from the front panel. These include port extension and modifying the calibration "thru" definition. Each of these techniques will now be discussed, including a technique to modify the traditional twelve-term error model to include the complete S-parameter model for each side of the test fixture.

Simple corrections for fixture effects

Port extensions

The simplest form of de-embedding is port extensions, which mathematically extends the measurement plane towards the DUT. This feature is included in the firmware of most modern network analyzers such as the Agilent E8358A. Port extensions assume that the test fixture looks like a perfect transmission line of some known phase length. It assumes the fixture has no loss, a linear phase response, and constant impedance. Port extensions are usually applied to the measurements after a two-port calibration has been performed at the end of the test cables. If the fixture performance is considerably better than the specifications of the DUT, this technique may be sufficient.

Port extension only adds or subtracts phase length from the measured S-parameter. It does not compensate for fixture losses or impedance discontinuities. In most cases, there will be a certain amount of mismatch interaction between the coax-to-fixture transition and the DUT that will create uncertainty in the measured S-parameter. This uncertainty typically results in an observed ripple in the S-parameter when measured over a wide frequency range. As an example, consider the measurements shown in Figure 13 of a short placed at the end of two different constant impedance transmission lines: a high-quality coaxial airline (upper curve), and a microstrip transmission line (lower curve). Port extensions were used to move the measurement plane up to the short. However, as seen in the figure, port extension does not compensate for the losses in the transmission line.

Also note that the airline measurement exhibits lower ripple in the measured S11 trace while the coax-to-microstrip test fixture shows a much larger ripple. Generally, the ripple is caused by interaction between the discontinuities at the measurement and device planes. The larger ripple in the lower trace results from the poor return loss of the microstrip transition (20 dB versus >45 dB for the airline). This ripple can be reduced if improvements are made in the return loss of the transition section.

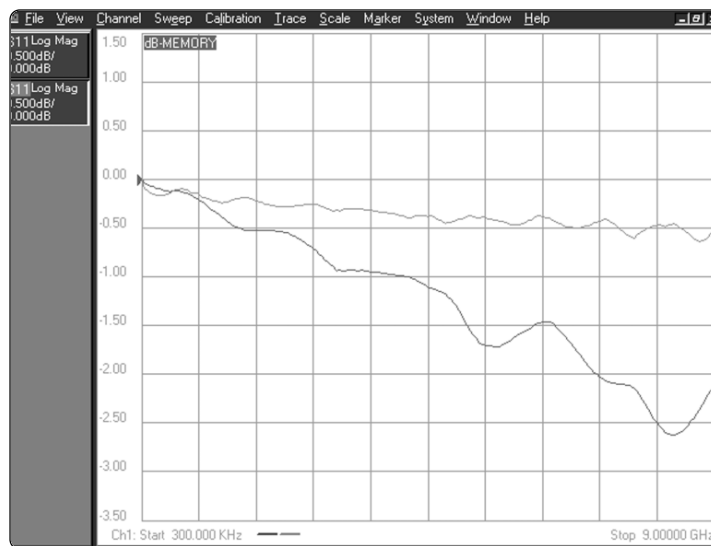

Figure 13. Port extension applied to a measurement of a short at the end of an airline (upper trace) and at the end of a microstrip transmission line (lower trace)

Modifying calibration standards

During calibration of the vector network analyzer, the instrument measures actual, well-defined standards such as the open, short, load and thru, and compares the measurements to ideal models for each standard. Any differences between the measurements and the models are used to compute the error terms contained within the measurement setup. These error terms are then used to mathematically correct the actual measurements of the device under test. This calibration process creates a reference or calibration plane at the point where the standards are connected. As long as a precise model is known for each calibration standard, an accurate reference plane can be established. For example, in some Agilent coaxial calibration kits, the short standard is not a true short at the reference plane, it is actually an “offset” short. The offset short consists of a small piece of coaxial transmission line placed between the connector and the true short. When selecting a calibration kit (definition), you are instructing the instrument to use the correct model for the offset short. For example, when using the Agilent 85033C 3.5mm coaxial calibration kit, the short standard uses an offset length of 50 ohm transmission line equal to a delay of 16.695 psec. When the analyzer uses the proper model for the offset short, then the reference will be correctly calculated.

Another way to implement the reference plane or port extensions, discussed in the previous section, would be to redefine the cal kit definitions for each of the calibration standards. For example, if we wanted to extend each reference plane a value of 100 psec past the point of calibration, we can modify each standard definition to include this 100 psec offset. This value would be subtracted from the original offset delay of the short, open and load standards. The “thru” definition would include the total delay of the extensions from each port. As an example, when using the Agilent 85033E cal kit, we would modify the short definition to have an offset delay of -68.202 psec (calculated from 31.798-100 psec, with the original 3.5mm short delay of 31.798 psec). The same approach is applied to the open and load standards. The “thru” definition would have an offset delay of -200 psec (0-100-100 psec, using the original thru delay of 0 psec). The thru definition requires the delay contributions from the port 1 and port 2 port extensions.

The calibration kit definition actually includes three offset characteristics for each standard.⁷ They are Offset Delay, Offset Loss and Offset Impedance (Z0). These three characteristics are used to accurately model each standard so the analyzer can establish a reference plane for each of the test ports.

Fixture de-embedding can be accomplished by adjusting the calibration kit definition table to include the effects of the test fixture. In this way, some of the fixture characteristics can be included in the error terms determined during the coaxial calibration process. Once the calibration is complete, the analyzer will mathematically remove the delay, loss and impedance of the fixture. It should be noted that some accuracy improvements would be seen over the previously discussed port extension technique, but some assumptions made about the fixture model will limit the overall measurement accuracy of the system. We will now discuss the implementation and limitations of modifying the cal kit definition to include the characteristics of the test fixture.

Offset delay

The test fixture will have electrical delay between the measurement plane and DUT due to the signal transmission time through the fixture. For coaxial transmission lines, the delay can be obtained from the physical length, propagation velocity of light in free space and the permittivity constant.

$$\text{Delay (seconds)} = \frac{\ell \sqrt{\epsilon_r}}{c}$$

ℓ = Physical length in meters

ϵ_r = Relative permittivity

$c = 2.997925 \times 10^8$ m/s

Here we assumed that the relative permeability, μ_r , equals one. Note the electrical delay for transmission lines other than coax, such as microstrip, will have a require a modification to the above equation due the change in the effective permittivity of the transmission media. Most RF software simulators, such as the Agilent ADS LineCalc tool, will calculate the effective phase length and effective permittivity of a transmission line based on the physical parameters of the circuit. The effective phase can be converted to electrical delay using the following equation.

$$\text{Delay (seconds)} = - \frac{\phi}{360 f}$$

ϕ Effective phase (degrees)

f Frequency (Hz)

The “thru” standard would be modified to include the delay from the total fixture length. The short, open and load standards would be modified to one half this delay, since we are extending the reference planes half way on each side. Here we assume that the device under test is placed directly in the middle of the fixture. Note that adjustments can be made to the cal kit definition table should the fixture be asymmetrical. In this case two sets of shorts, opens and loads would be defined, a separate set for each test port.

Offset loss

The network analyzer uses the offset loss to model the magnitude loss due to skin effect of a coaxial type standard. Because the fixture is non-coaxial, the loss as a function of frequency may not follow the loss of a coaxial transmission line so the value entered may only approximate the true loss of the fixture. The value of loss is entered into the standard definition table as gigohms/second or ohms/nanosecond at 1 GHz.

The offset loss in gigohms/second can be calculated from the measured loss at 1 GHz and the physical length of the particular standard by the following equation:

$$\text{Offset Loss } \left(\frac{\text{G}\Omega}{\text{s}} \right) \Big|_{1\text{GHz}} = \frac{\text{dB}_{\text{loss}} \Big|_{1\text{GHz}} \cdot c \cdot \sqrt{\epsilon_r} \cdot Z_0}{10 \log_{10}(e) \ell}$$

where:

$\text{dB}_{\text{loss}} @ 1\text{GHz}$ = measured insertion loss at 1 GHz

Z_0 = offset Z_0

ℓ = physical length of the offset

Figure 14 shows the true insertion loss of a microstrip thru line (lower trace). This figure also shows a S21 measurement of the fixture “thru” after modifying the cal kit definition to include the effects of the fixture loss (top curve). For this case, we would expect the measured loss of the fixture “thru” (after calibration) to be a flat line with 0 dB insertion loss. The actual measurement shows a trade-off between the high and low frequencies by adjusting the offset loss to be optimized in the middle of the band. The offset loss was set to 10 Gohm/sec for the FR-4 material used. For this case, a 3-inch length of microstrip 50-ohm transmission line was used with an approximate dielectric constant of 4.3 and loss tangent value of 0.012. The value of 10 Gohm/sec for the offset loss is a good compromise across the 300 kHz to 9 GHz frequency range. This value can easily be modified to optimize the offset loss over the frequency range of interest.

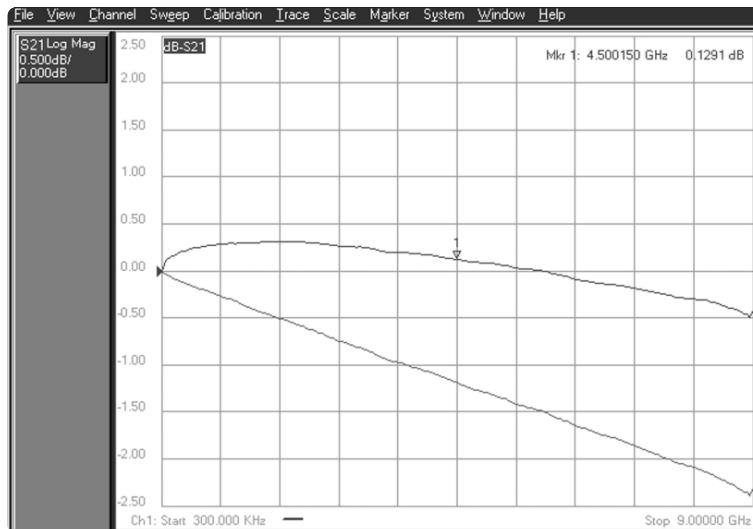

Figure 14. Measurement of a microstrip “thru” line (lower trace) and the test fixture “thru” after the VNA was calibrated with a modified adapter loss (upper trace)

Offset Z_0

The offset Z_0 is the characteristic impedance within the offset length. Modification of this term can be used to enter the characteristic impedance of the fixture.

Modifying the standards definition

Modification of the cal kit standards definition is easily performed on the E8358A using the Advanced Modify Cal Kit dialog. Figure 15 shows the definition table which is used to change the offset delay, offset loss and offset impedance for the short, open, load and thru model definitions.

We begin the process by selecting the coaxial cal kit that will be used to calibrate the vector network analyzer over the frequency range of interest. We also require the values for offset delay, loss and impedance of the test fixture. As an example, we will assume that the total “thru” delay of the fixture is 650 psec, the offset loss is calculated as 10 Gohm/s and the offset impedance is 50 ohms. We will also assume that the fixture is symmetrical and each half of the fixture introduces 325 psec of delay (this value will be used to modify the short, open and load definitions). The selected coaxial calibration kit definition will now be modified to include the characteristics of the test fixture.

Adjust the short delay to a value calculated by subtracting the delay introduced by the fixture half, from the original definition. For example, when using the 85033E 3.5mm calibration kit, the original offset delay is defined as 31.798 psec. Change this value to -293.202 psec (calculated from 31.798-325 psec, in our example). Modify the loss to 10 Gohm/s. The offset impedance can remain at 50 ohms for this example. Perform the same adjustments for the open and load definitions.

The thru delay is modified to a value equal to original delay minus the total delay thru the test fixture. For this example, the modified thru delay would be set to -650 psec, since the original delay is 0 psec. The thru loss is also set to 10 Gohms/sec and Z_0 is 50 ohms.

Once the standards definitions are modified to include the test fixture characteristics, the updated cal kit can be saved as a user kit on the network analyzer. Give the new cal kit a specific name to distinguish it from the other kits stored in the analyzer memory. The E8358A PNA also assigns Kit ID numbers to each cal kit definition table.

The analyzer calibration can now be performed using a standard coaxial, full two-port calibration with the new cal definition selected for the cal kit type. The test fixture is not connected until after the coaxial calibration is complete. The error correction mathematics in the analyzer will include the effects of the test fixture loss, delay and impedance in the calibration.

Changing the offset definitions will compensate for the linear phase shift, constant impedance and, somewhat approximate the loss of the test fixture. Here we are assuming that the loss of the fixture follows the skin effect loss of a coaxial transmission, which in most cases is not exactly valid. It also assumes that any mismatches between the transitions are solely created from an impedance discontinuity. Generally, the coaxial to non-coaxial transition cannot be modeled in such a simple manner and more elaborate models need to be implemented for the test fixture. Introduction of complex models for the fixture will require modifying the twelve-term error model used by the VNA during the error correction process. The next section describes the error model used by the vector network analyzer and the process that can be used to modify the error terms stored in the analyzer’s memory.

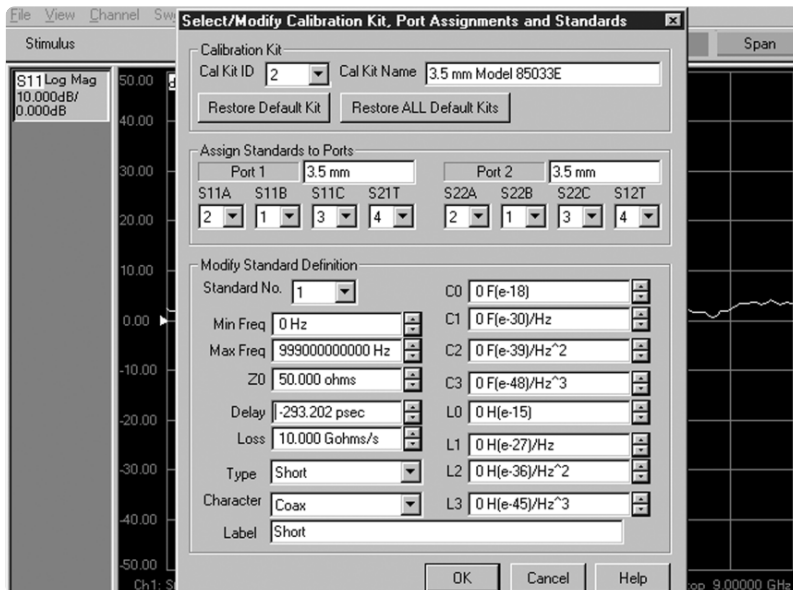

Figure 15 E8358A PNA dialog showing the modified cal kit definition

Modifying the twelve-term error model

In this section, we review the twelve-term error model used in the VNA to remove the systematic error of the test equipment. We then develop the de-embedding mathematics in order to combine the test fixture model into the VNA's error model. In this way, the VNA can directly display measurement data without including the effects of the fixture.

VNA calibration and error models

Measurement errors exist in any network measurement. When using a VNA for the measurement, we can reduce the measurement uncertainty by measuring or calculating the causes of uncertainty. During the VNA calibration, the system measures the magnitude and phase responses of known devices, and compares the measurement with actual device characteristics. It uses the results to characterize the instrument and effectively remove the systematic errors from the measured data of a DUT.⁸

Systematic errors are the repeatable errors that result from the non-ideal measurement system. For example, measurement errors can result from directivity effects in the couplers, cable losses and mismatches between the test system and the DUT. A typical two-port coaxial test system can be modeled as having twelve errors that can be corrected. These errors are characterized during system calibration and mathematically removed from the DUT measurements. As long as the measurement system is stable over time and temperature, these errors are repeatable and the same calibration can be used for all subsequent measurements.

In a way, the VNA calibration process is de-embedding the system errors from the measurement. Figure 16 shows the three system errors involved when measuring a one-port device. These errors separate the DUT measurement from an ideal measurement system. E_{df} is the forward directivity error term resulting from signal leakage through the directional coupler on Port 1. E_{rf} is the forward reflection tracking term resulting from the path differences between the test and reference paths. E_{sf} is the forward source match term resulting from the VNA's test port impedance not being perfectly matched to the source impedance. We can refer to this set of terms as the Error Adapter coefficients of the one-port measurement system. These forward error terms are defined as those associated with Port 1 of the VNA. There are another three terms for the reverse direction associated with reflection measurements from Port 2.

The VNA calibration procedure requires a sufficient number of known devices or calibration standards. In this case three standards are used for a one-port calibration. The VNA calculates the terms in the Error Adapter based on direct or raw measurements of these standards. A typical coaxial calibration kit contains a short, open and load standard for use in this step of the process. Once the Error Adapter is characterized, corrected measurements of a DUT can be display directly on the VNA display. The equation for calculating the actual S_{11A} of the DUT is shown below. This equation uses the three reflection error terms and the measured S_{11M} of the DUT.

$$S_{11A} = \frac{(S_{11M} - E_{df})}{E_{sf}(S_{11M} - E_{df}) + E_{rf}}$$

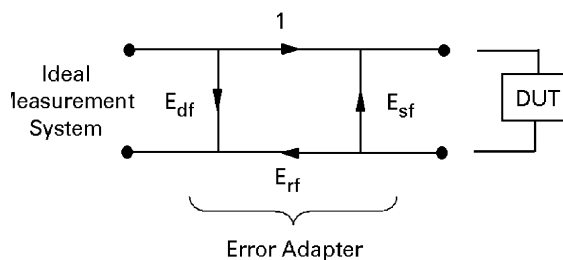

Figure 16. Signal flow diagram of a one-port error adapter model

Expanding the above model of the Error Adapter for two-port measurements, we find that there exists an additional three error terms for measurements in the forward direction. Once again, we define forward measurements as those associated with the stimulus signal leaving Port 1 of the VNA. The additional error terms are E_{df} , E_{sf} , and E_{xf} for forward transmission, forward load match and forward crosstalk respectively. The total number of error terms is twelve, six in the forward direction and six in the reverse. The flow diagram for the forward error terms in the two-port error model is shown in Figure 17. This figure also shows the S-parameters of the DUT. This forward error model is used to calculate the actual S11 and S21 of the DUT. Calculations of the actual S12 and S22 are performed using the reverse error terms. The error model for the reverse direction is the same as in Figure 17, with all of the forward terms replaced by reverse terms.⁸

Modifying the error terms to include the fixture error

If we examine the forward error model and insert a test fixture before and after the DUT, we can create a new flow graph model that includes the fixture terms. Figure 18 shows the original forward calibration terms being cascaded with the fixture error terms. This figure also shows how the two sets of error terms can be combined into a new set of forward error terms denoted with a primed variable. The same holds true for the reverse error model. It should be noted that for the VNA to correct for both the systematic errors in the test equipment and errors in the test fixture, the combined error model must still fit into a traditional twelve-term error model. This includes using a unity value for the forward transmission term on the left side of the flow diagram.⁹

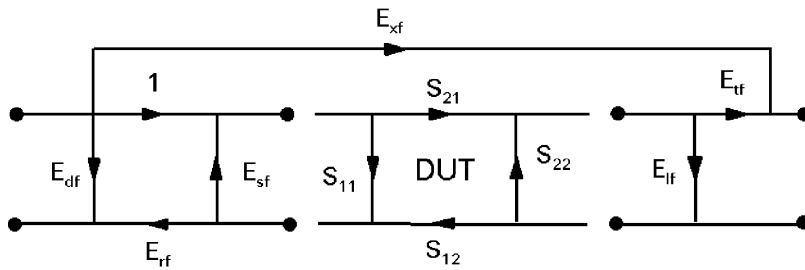

Figure 17. Signal flow diagram of the forward two-port error terms

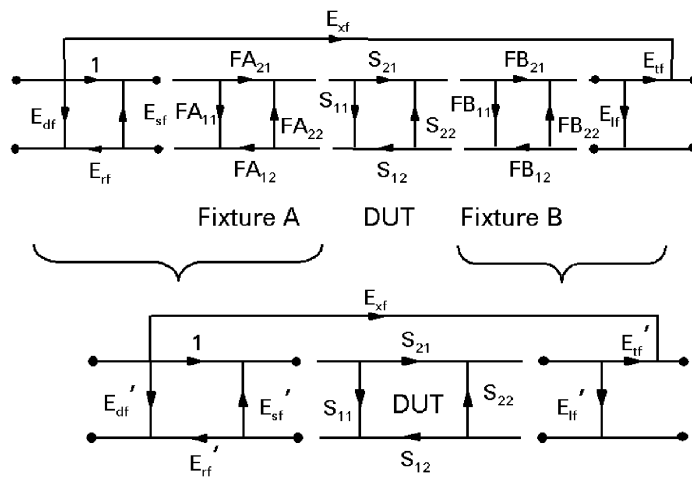

Figure 18. Signal flow diagram of the combined test fixture S-parameters with the forward two-port error terms

Renormalizing the modified error terms, we find the set of equations that are used to represent the combined errors of the instrument and the fixture. Once these terms are entered into the analyzer's error correction algorithm, the displayed measurements will be those of the DUT only at the device plane. The test fixture effects will be de-embedded from the measurement.

$$\begin{aligned}
 E_{df}' &= E_{df} + \frac{(E_{df}FA_{11})}{(1-E_{sf}FA_{11})} & E_{dr}' &= E_{dr} + \frac{(E_{dr}FB_{22})}{(1-E_{sr}FB_{22})} \\
 E_{sf}' &= FA_{22} + \frac{(E_{sf}FA_{12}FA_{21})}{(1-E_{sf}FA_{11})} & E_{sr}' &= FB_{11} + \frac{(E_{sr}FB_{12}FB_{21})}{(1-E_{sr}FB_{22})} \\
 E_{ff}' &= \frac{(E_{ff}FA_{12}FA_{21})}{(1-E_{sf}FA_{11})^2} & E_{rr}' &= \frac{(E_{rr}FB_{12}FB_{21})}{(1-E_{sr}FB_{22})^2} \\
 E_{yf}' &= FB_{11} + \frac{(E_{yf}FB_{12}FB_{21})}{(1-E_{yf}FB_{22})} & E_{yr}' &= FA_{22} + \frac{(E_{yr}FA_{12}FA_{21})}{(1-E_{yr}FA_{11})} \\
 E_{yf}' &= \frac{(E_{yf}FA_{21}FB_{21})}{((1-E_{yf}FB_{22})(1-E_{sf}FA_{11}))} & E_{yr}' &= \frac{(E_{yr}FA_{12}FB_{12})}{((1-E_{yr}FA_{11})(1-E_{sr}FB_{22}))} \\
 E_{sf}' &= E_{sf} & E_{xr}' &= E_{xr}
 \end{aligned}$$

E_{df} = Forward (Port 1) Directivity

E_{sf} = Forward (Port 1) Source Match

E_{rf} = Forward (Port 1) Reflection Tracking

E_{xf} = Forward (Port 1) Isolation

E_{yf} = Forward (Port 1) Load Match

E_{tf} = Forward (Port 1) Transmission Tracking

E_{dr} = Reverse (Port 2) Directivity

E_{sr} = Reverse (Port 2) Source Match

E_{rr} = Reverse (Port 2) Reflection Tracking

E_{xr} = Reverse (Port 2) Isolation

E_{yr} = Reverse (Port 2) Load Match

E_{tr} = Reverse (Port 2) Transmission Tracking

FA_{11} = S11 Test Fixture A (Left Side)

FA_{21} = S21 Test Fixture A (Left Side)

FA_{12} = S12 Test Fixture A (Left Side)

FA_{22} = S22 Test Fixture A (Left Side)

FB_{11} = S11 Test Fixture B (Right Side)

FB_{21} = S21 Test Fixture B (Right Side)

FB_{12} = S12 Test Fixture B (Right Side)

FB_{22} = S22 Test Fixture B (Right Side)

There are two error terms that are not modified in the equations. They are the forward and reverse crosstalk error terms, E_{xf} and E_{xr} . Here we assume that the leakage signal across the test fixture is lower than the isolation error term inside the instrument. In some cases, this may not be a valid assumption, especially when using test fixtures with microstrip transmission lines. Often radiation within the fixture will decrease the isolation between the two test ports of the instrument. Before trying to model these isolation terms, we must decide if the terms will introduce significant error into the measurement of the DUT. If we are trying to measure a DUT that has 10 dB insertion loss (S21) and the isolation of the fixture is 60 dB, the difference between these two signals is 50 dB and the error introduced into the S21 measurement is less than 0.03 dB and 0.2 degrees. Unless the DUT measurement has a very large insertion loss, on the order of the test fixture or instrument isolation, then the crosstalk error terms can be used without modification and often omitted altogether from the VNA calibration.

Should the DUT have a very large insertion loss, it may be necessary to include the isolation term of the fixture in the de-embedding model. This term could be measured by placing two terminations inside the test fixture and measuring the leakage or isolation of the fixture.

Steps to perform de-embedding on the VNA

The de-embedding process begins with creating a model of the test fixture placed on either side of the DUT. The accuracy of the model directly affects the accuracy of the de-embedded measurements on the DUT.

The next step is to perform a standard coaxial two-port calibration on the VNA using any calibration type such as SOLT (Short, Open, Load, Thru) or TRL (Thru, Reflect, Line). Because this technique uses the traditional twelve-term error model, network analyzers that use either three or four receivers can be used. This calibration is then saved to the instrument memory. This same de-embedding technique can be applied to one-port devices by modifying only the first three error terms, namely E_{df} , E_{sf} , E_{rf} for Port 1 measurements and E_{dr} , E_{sr} , E_{rr} for Port 2.

Using a full two-port calibration, the twelve error terms are then downloaded into a computer program and modified using the model(s) for each side of the test fixture. The twelve modified error terms are then placed back into the analyzer's calibration memory. At this point, the VNA now displays the de-embedded response of the DUT. All four S-parameters can be displayed without the effects of the test fixture in real-time.

Using the internal automation capability on the E8358A PNA Series Network Analyzer, this technique can be easily implemented without requiring an external computer. This family of network analyzers is PC-based, running the Windows® 2000 operating system. The fixture model can be downloaded into the instrument using the internal floppy drive, built-in LAN interface or any USB compatible device.

To show the effects of fixture de-embedding on the calibration error coefficients, let's examine the directivity error term. Figure 19 shows the forward directivity error term for the E8358A PNA series network analyzer. The lower trace is the directivity error using a standard 3.5 mm coaxial calibration kit. The upper trace is the same term modified to de-embed the effects of a coax-to-microstrip test fixture. Because the directivity is the sum of all the leakage signals appearing at the receiver input with a good termination placed at the test port, uncertainty in this error term will generally affect the reflection measurements of well-matched DUTs. For this example, unless de-embedding is performed, the test fixture will degrade the capability for measuring return loss down to the raw performance of the fixture, which is about 15 dB in this case.

As a measurement example, let's measure the return loss and gain of a surface-mount amplifier placed in a microstrip test fixture. We can compare the measured results when calibrating the analyzer using a standard two-port coaxial calibration versus de-embedding the test fixture using a model of the coax-to-microstrip fixture. Figure 20 shows the measured S11 of the amplifier over a 2 GHz bandwidth. For the case when using a standard coaxial calibration, the measured S11 shows excessive ripple in the response due to mismatch interaction between the test fixture and the surface-mount amplifier. When the test fixture is de-embedded from the measurement, the actual performance of the amplifier is shown with a linear behavior as a function of frequency.



Figure 19. Forward directivity error term (1) using standard coaxial calibration (lower trace) and (2) modified to include the effects of a coax-to-microstrip test fixture (upper trace)

We can also examine the measured S21 with and without the effects of de-embedding the test fixture. Figure 21 shows the measured gain response over the 2-4 GHz band. Much like the S11 response, the measurement using a standard coaxial calibration shows additional ripple in the S21 response. The overall gain is also reduced by about 0.5 dB due to the additional fixture insertion loss included in the measurement. Once the fixture is de-embedded, the measured amplifier gain displays more gain and lower ripple across the frequency band.

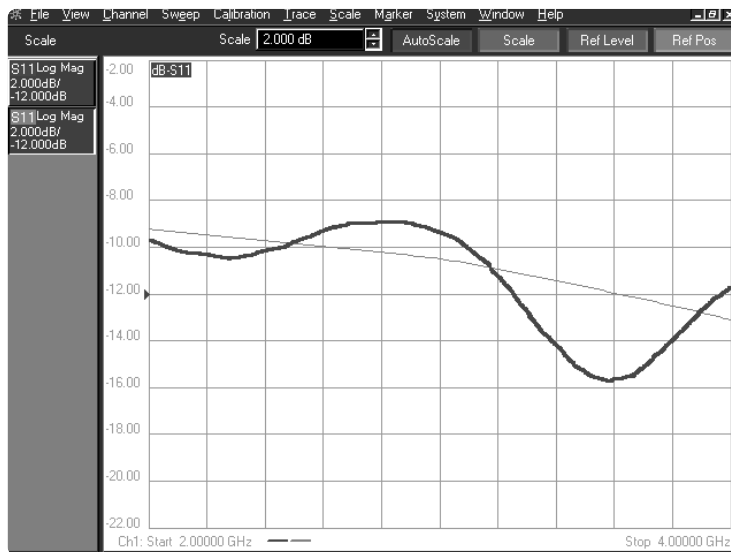

Figure 20. Measured S11 of a surface mount amplifier. The trace with the large ripple is the response using a standard coaxial calibration. The linear trace shows the de-embedded response

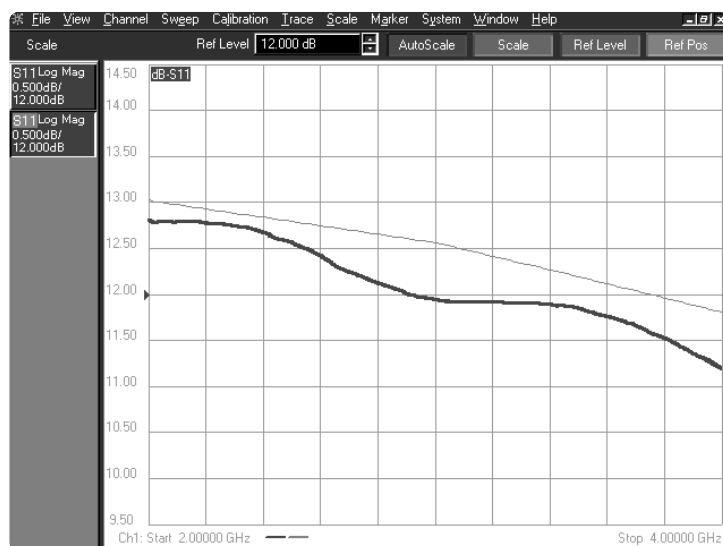

Figure 21. Measured S21 of a surface mount amplifier. The lower trace shows the response using a standard coaxial calibration and the upper trace shows the de-embedded response

Embedding a virtual network

The de-embedding process is used to remove the effects of a physical network placed between the VNA calibration or measurement plane and the DUT plane. Alternately, this same technique can be used to insert a hypothetical or “virtual” network between the same two planes. This would allow the operator to measure the DUT as if it were placed into a larger system that does not exist. One example where this technique can be very useful is during the tuning process of a DUT. Often the device is first pre-tuned at a lower circuit level and later placed into a larger network assembly. Due to interaction between the DUT and the network, a second iteration of device tuning is typically required. It is now possible to embed the larger network assembly into the VNA measurements using the de-embedding process described in this paper. This allows real-time measurements of the DUT including the effects of the virtual network. The only additional step required is to create the “anti-network” model of the virtual network to be embedded.

The anti-network is defined as the two-port network that, when cascaded with another two-port network, results in the identity network. Figure 22 shows the cascaded networks $[S]$ and $[S^A]$, representing the original network and its anti-network. These two networks, when cascaded together, create an ideal network that is both reflectionless and lossless. If we insert these two networks, $[S]$ and $[S^A]$, between the measurement plane and DUT plane, we would find no difference in any measured S-parameter of the DUT. The process of de-embedding moves the measurement plane toward the DUT plane. Alternatively, the process of embedding a network would move the measurement plane away from the device plane (Figure 23). Therefore, movement of the measurement plane toward the DUT (de-embedding) through the anti-network, $[S^A]$, is the same as movement of the measurement plane away from the DUT (embedding) through the network, $[S]$.

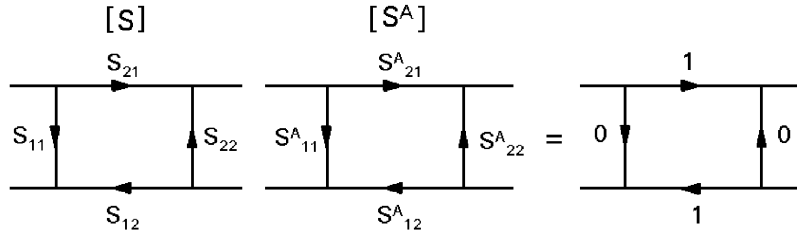

Figure 22. Definition of the identity matrix using a network and the anti-network representations

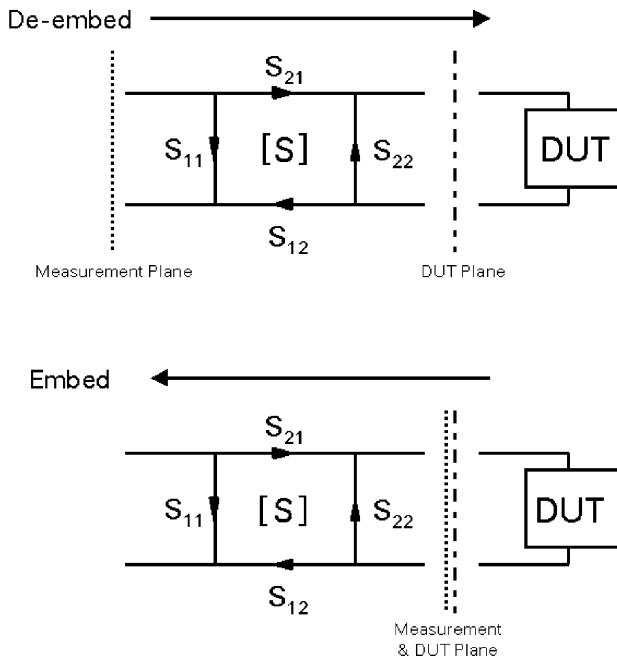

Figure 23. Diagram showing the movement in the measurement plane during de-embedding and embedding of a two-port network

In order to embed a network, it is only necessary to first calculate the anti-network and apply the same de-embedding algorithm that was previously developed. The equations for calculating the anti-network are shown below.

$$S_{11}^A = \frac{S_{11}}{(S_{11}S_{22} - S_{21}S_{12})} \quad S_{12}^A = \frac{(1 - S_{22}S_{11}^A)}{S_{12}}$$

$$S_{21}^A = \frac{(1 - S_{22}S_{11}^A)}{S_{21}} \quad S_{22}^A = \frac{(S_{12}^A S_{21}^A S_{22})}{(S_{22}S_{11}^A - 1)}$$

As an example of embedding a virtual network into a measured response, let's measure a surface-mount amplifier with a virtual bandpass filter network placed after the amplifier. Figure 24 shows the measured response before and after embedding the filter network. The upper trace shows the measured gain of the amplifier only. Here the amplifier gain is relatively flat over the 2 GHz bandwidth. The lower trace shows the response of the amplifier and embedded filter network. In this case, the measured gain is modified to include the effects of the bandpass filter network. By embedding a virtual filter into the VNA's error terms, we can optimize the amplifier's gain using a model of the filter that is not physically part of the actual measurement.

Summary

This application note described the techniques of de-embedding and embedding S-parameter networks with a device under test. Using the error-correcting algorithms of the vector network analyzer, the error coefficients can be modified so that the process of de-embedding or embedding two port networks can be performed directly on the analyzer in real-time.

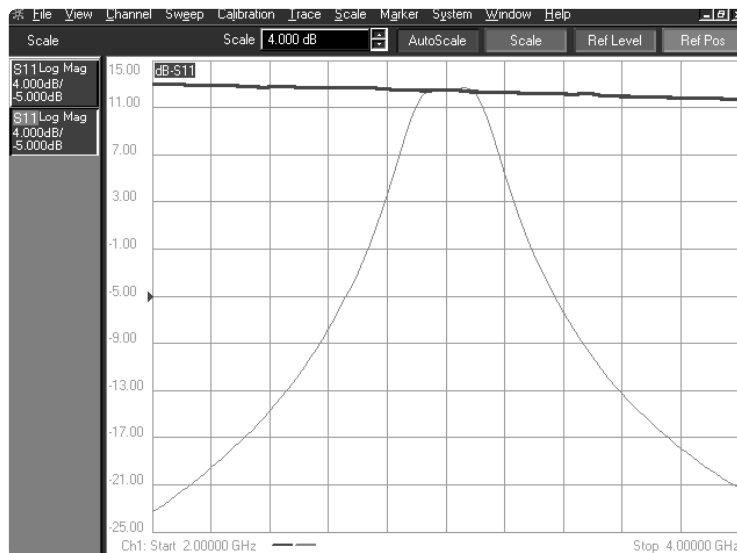

Figure 24. Measured S21 showing the effects of embedding a virtual bandpass filter network into the measurement of a surface mount amplifier. Upper trace is the measured response of the amplifier only. Lower trace shows the response including an embedded filter network

Appendix A : Relationship of S and T parameter matrices

To determine the scattering transfer parameters or T-parameters of the two-port network, the incident and reflected waves must be arranged so the dependent waves are related to Port 1 of the network and the independent waves are a function of Port 2 (see Figure A1). This definition is useful when cascading a series of two-port networks in which the output waves of one network are identical to the input waves of the next. This allows simple matrix multiplication to be used with the characteristic blocks of two-port networks.

The mathematical relationship between the T-parameters and S-parameters is shown below in Figure A2.



$$\begin{bmatrix} b_1 \\ a_1 \end{bmatrix} = \begin{bmatrix} T_{11} & T_{12} \\ T_{21} & T_{22} \end{bmatrix} \begin{bmatrix} a_2 \\ b_2 \end{bmatrix}$$

Figure A1. Definition of the two-port T-parameter network

$$\begin{bmatrix} S_{11} & S_{12} \\ S_{21} & S_{22} \end{bmatrix} = \begin{bmatrix} \frac{T_{12}}{T_{22}} & \frac{T_{11}T_{22} - T_{12}T_{21}}{T_{22}} \\ \frac{1}{T_{22}} & -\frac{T_{21}}{T_{22}} \end{bmatrix}$$

$$\begin{bmatrix} T_{11} & T_{12} \\ T_{21} & T_{22} \end{bmatrix} = \begin{bmatrix} -\frac{S_{11}S_{22} - S_{12}S_{21}}{S_{21}} & \frac{S_{11}}{S_{21}} \\ -\frac{S_{22}}{S_{21}} & \frac{1}{S_{21}} \end{bmatrix}$$

Figure A2. Relationship between the T-parameters and S-parameters

References

- 1) Edwards, T.C., *Foundations of Microstrip Circuit Design*, John Wiley & Sons, 1981
- 2) *In-Fixture Measurements Using Vector Network Analyzers*, Agilent Application Note 1287-9, May 1999
- 3) *Use Agilent EEsof and a Vector Network Analyzer to Simplify Fixture De-Embedding* Agilent White Paper, part number 5968-7845E, October 1999.
- 4) *S Parameter Design*, Agilent Application Note 154, April 1972 (CHECK THIS NOTE FOR THE LATEST REPRINT)
- 5) *Understanding the Fundamental Principles of Vector Network Analyzers*, Agilent Application Note 1287-1, May 1997
- 6) Hunton, J.K. *Analysis of Microwave Measurement Techniques by Means of Signal Flow Graphs*, IRE Transactions on Microwave Theory and Techniques, March 1960. Available on the IEEE MTT Microwave Digital Archive, IEEE Product Number JP-17-0-0-C-0
- 7) *Specifying Calibration Standards For The Agilent 8510 Network Analyzer* Product Note 8510-5A, July 2000
- 8) *Applying Error Correction to Network Analyzer Measurements*, Agilent Application Note 1287-3, April 1999
- 9) Elmore, G. *De-embedded Measurements Using the 8510 Microwave Network Analyzer*, Hewlett-Packard RF & Microwave Symposium, 1985.

Agilent Technologies' Test and Measurement Support, Services, and Assistance

Agilent Technologies aims to maximize the value you receive, while minimizing your risk and problems. We strive to ensure that you get the test and measurement capabilities you paid for and obtain the support you need. Our extensive support resources and services can help you choose the right Agilent products for your applications and apply them successfully. Every instrument and system we sell has a global warranty. Support is available for at least five years beyond the production life of the product. Two concepts underlie Agilent's overall support policy: "Our Promise" and "Your Advantage."

Our Promise

Our Promise means your Agilent test and measurement equipment will meet its advertised performance and functionality. When you are choosing new equipment, we will help you with product information, including realistic performance specifications and practical recommendations from experienced test engineers. When you use Agilent equipment, we can verify that it works properly, help with product operation, and provide basic measurement assistance for the use of specified capabilities, at no extra cost upon request. Many self-help tools are available.

Your Advantage

Your Advantage means that Agilent offers a wide range of additional expert test and measurement services, which you can purchase according to your unique technical and business needs. Solve problems efficiently and gain a competitive edge by contracting with us for calibration, extra-cost upgrades, out-of-warranty repairs, and onsite education and training, as well as design, system integration, project management, and other professional engineering services. Experienced Agilent engineers and technicians worldwide can help you maximize your productivity, optimize the return on investment of your Agilent instruments and systems, and obtain dependable measurement accuracy for the life of those products.

By internet, phone, or fax, get assistance with all your test & measurement needs

Phone or Fax

United States:

(tel) 800 829 4444

Canada:

(tel) 877 894 4414

(fax) 905 282 6495

China:

(tel) 800 810 0189

(fax) 800 820 2816

Europe:

(tel) (31 20) 547 2323

(fax) (31 20) 547 2390

Japan:

(tel) (81) 426 56 7832

(fax) (81) 426 56 7840

Korea:

(tel) (82 2) 2004 5004

(fax) (82 2) 2004 5115

Latin America:

(tel) (305) 269 7500

(fax) (305) 269 7599

Taiwan:

(tel) 0800 047 866

(fax) 0800 286 331

Other Asia Pacific Countries:

(tel) (65) 6375 8100

(fax) (65) 6836 0252

Email: tm_asia@agilent.com

Online Assistance:

www.agilent.com/find/assist

Product specifications and descriptions in this document subject to change without notice.

© Agilent Technologies, Inc. 2001, 2004

Printed in USA, May 30, 2004

5980-2784EN



Agilent Email Updates

www.agilent.com/find/emailupdates

Get the latest information on the products and applications you select.

Agilent T&M Software and Connectivity

Agilent's Test and Measurement software and connectivity products, solutions and developer network allows you to take time out of connecting your instruments to your computer with tools based on PC standards, so you can focus on your tasks, not on your connections. Visit **www.agilent.com/find/connectivity** for more information.

Windows® and MS Windows® are U.S. registered trademarks of Microsoft Corp.



Agilent Technologies