

Agilent E5071C ENA Network Analyzer

- 9 kHz to 4.5/6.5/8.5 GHz
- 100 kHz to 4.5/6.5/8.5 GHz (with bias tees)
- 300 kHz to 14/20 GHz (with bias tees)

E5091A Multiport Test Set

E5092A Configurable Multiport Test Set

Data Sheet

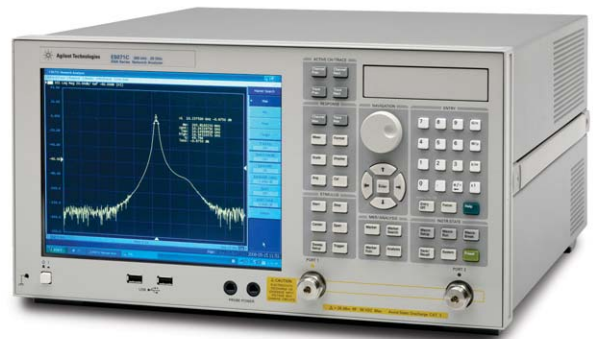

Agilent Technologies

Table of Contents

Options	3
Definitions	4
Boundary Conditions	4
Corrected System Performance	5
System dynamic range	5
Corrected system performance with calibration kit.....	7
Uncorrected System Performance	13
Test Port Output (Source)	14
Test port output frequency	14
Test port output power	15
Test port output signal purity	17
Test Port Input	18
Test port input levels	18
Test port input (trace noise).....	20
Test port input (stability)	22
Test port input (dynamic accuracy).....	23
Test port input (group delay).....	25
General Information	27
System bandwidths.....	27
Front panel information.....	27
Rear panel information.....	28
LXI compliance.....	30
EMC, safety and environment.....	31
Analyzer environmental specifications and dimensions.....	32
Measurement Throughput Summary	36
Typical cycle time for measurement completion (ms).....	36
Cycle time (ms) vs. number of points.....	48
Cycle time (ms) vs. IF bandwidth	49
Data transfer time (ms).....	50
E5091A Multiport Test Set	51
Test set input/output performance.....	51
Option E5091A-009 port performance	51
Option E5091A-016 port performance	52
Front panel information.....	52
Rear panel information.....	52
Test set dimensions and block diagram.....	53
E5092A Configurable Multiport Test Set	56
Test set input/output performance.....	56
Option E5092A-020 port performance	56
Control line	58
DC source.....	58
Operating storage environment.....	58
Non-operating storage environment.....	58
Front panel information.....	59
Rear panel information.....	59
Test set dimensions and block diagram.....	59
Corrected System Performance for 75 Ω Measurements with 11852B 50 to 75 Ω Minimum-Loss Pads	63

Options

This document provides technical specifications for the E5071C ENA network analyzer and the E5091A multiport test set.

E5071C-230	2-port test set, 9 kHz to 3 GHz without bias tees (Discontinued)
E5071C-235	2-port test set, 100 kHz to 3 GHz with bias tees (Discontinued)
E5071C-240	2-port test set, 9 kHz to 4.5 GHz without bias tees
E5071C-245	2-port test set, 100 kHz to 4.5 GHz with bias tees
E5071C-260	2-port test set, 9 kHz to 6.5 GHz without bias tees
E5071C-265	2-port test set, 100 kHz to 6.5 GHz with bias tees
E5071C-280	2-port test set, 9 kHz to 8.5 GHz without bias tees
E5071C-285	2-port test set, 100 kHz to 8.5 GHz with bias tees
E5071C-430	4-port test set, 9 kHz to 3 GHz without bias tees (Discontinued)
E5071C-435	4-port test set, 100 kHz to 3 GHz with bias tees (Discontinued)
E5071C-440	4-port test set, 9 kHz to 4.5 GHz without bias tees
E5071C-445	4-port test set, 100 kHz to 4.5 GHz with bias tees
E5071C-460	4-port test set, 9 kHz to 6.5 GHz without bias tees
E5071C-465	4-port test set, 100 kHz to 6.5 GHz with bias tees
E5071C-480	4-port test set, 9 kHz to 8.5 GHz without bias tees
E5071C-485	4-port test set, 100 kHz to 8.5 GHz with bias tees
E5071C-2D5	2-port test set, 300 kHz to 14 GHz with bias tees
E5071C-4D5	4-port test set, 300 kHz to 14 GHz with bias tees
E5071C-2K5	2-port test set, 300 kHz to 20 GHz with bias tees
E5071C-4K5	4-port test set, 300 kHz to 20 GHz with bias tees
E5091A	Multiport test set
E5092A	Configurable multiport test set

Calibration kits and ECal modules

This E5071C data sheet also provides technical specifications for the following calibration kits and ECal modules. For models not listed in this data sheet, please download the free Uncertainty Calculator from www.agilent.com/find/na_calculator to generate the curves for your calibration kit and enable ENA setup.

85032F	Calibration kit
85033E	Calibration kit
85052D	Calibration kit
85092C	Electronic calibration (ECal) module
85093C	Electronic calibration (ECal) module
N4691B	Electronic calibration (ECal) module

Definitions

Specification (spec.):

Warranted performance. All specifications apply at 23 °C (± 5 °C), unless otherwise stated, and 90 minutes after the instrument has been turned on. Specifications include guard bands to account for the expected statistical performance distribution, measurement uncertainties, and changes in performance due to environmental conditions.

Supplemental information is intended to provide information that is helpful for using the instrument but that is not guaranteed by the product warranty.

Typical (typ.):

Describes performance that will be met by a minimum of 80% of all products. It is not guaranteed by the product warranty.

Supplemental performance data (SPD):

Supplemental performance data represents the value of a parameter that is most likely to occur; the expected mean or average. It is not guaranteed by the product warranty.

General characteristics:

A general, descriptive term that does not imply a level of performance.

Boundary Conditions

In this data sheet, boundary conditions are given for the specifications. For example, system dynamic range is 98 dB with the following boundary conditions.

Option: 485

Frequency: 10 MHz

IF bandwidth: 3 kHz

If the same boundary conditions fall under more than one category in a table, apply the best value.

Corrected System Performance

The specifications in this section apply to measurements made with the Agilent E5071C network analyzer under the following conditions:

- No averaging applied to data
- Environmental temperature of 23 °C (± 5 °C) with less than 1 °C deviation from the calibration temperature
- Response and isolation calibration performed

System dynamic range

Table 1. Option 230/235/240/245/260/265/280/285/430/435/440/445/460/465/480/485

Description	Specification	SPD
System dynamic range^{1, 2}		
9 kHz to 300 kHz	IF bandwidth = 3 kHz	
300 kHz to 10 MHz		
10 MHz to 6 GHz		
6 GHz to 8.5 GHz		
9 kHz to 300 kHz	IF bandwidth = 10 Hz	115 dB
300 kHz to 10 MHz		115 dB
10 MHz to 6 GHz		130 dB
6 GHz to 7 GHz		128 dB
7 GHz to 8 GHz		126 dB
8 GHz to 8.5 GHz		124 dB

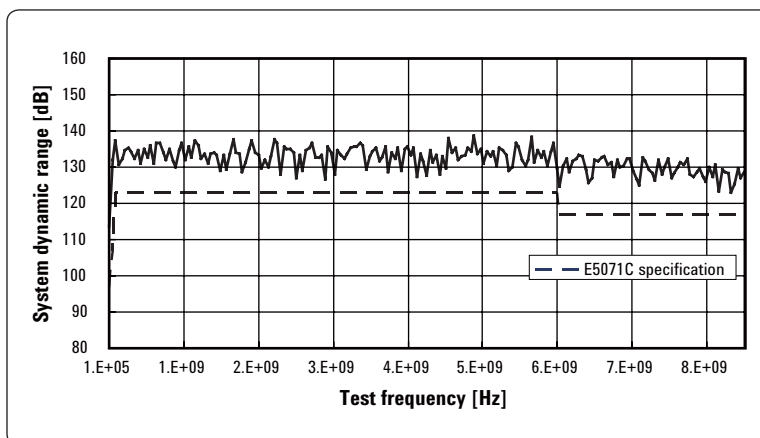

Figure 1. System dynamic range (specification and actual measurement data example, IF bandwidth 10 Hz)

1. The test port dynamic range is calculated as the difference between the test port rms noise floor and the source maximum output power. The effective dynamic range must take measurement uncertainty and interfering signals into account.
2. The specification might not be met at 5 MHz or 50 MHz.

System dynamic range (continued)

Table 2. Option 2D5/2K5/4D5/4K5

Description	Specification	SPD
System dynamic range^{1, 2}		
300 kHz to 1 MHz	IF bandwidth = 3 kHz	
1 MHz to 10 MHz		
10 MHz to 100 MHz		
100 MHz to 6 GHz		
6 GHz to 8.5 GHz		
8.5 GHz to 10.5 GHz		
10.5 GHz to 15 GHz		
15 GHz to 20 GHz		
300 kHz to 1 MHz		
1 MHz to 10 MHz	115 dB	
10 MHz to 100 MHz	129 dB	
100 MHz to 6 GHz	130 dB	
6 GHz to 8 GHz	129 dB	
8 GHz to 8.5 GHz	127 dB	
8.5 GHz to 10.5 GHz	115 dB	
10.5 GHz to 15 GHz	111 dB	
15 GHz to 20 GHz	105 dB	

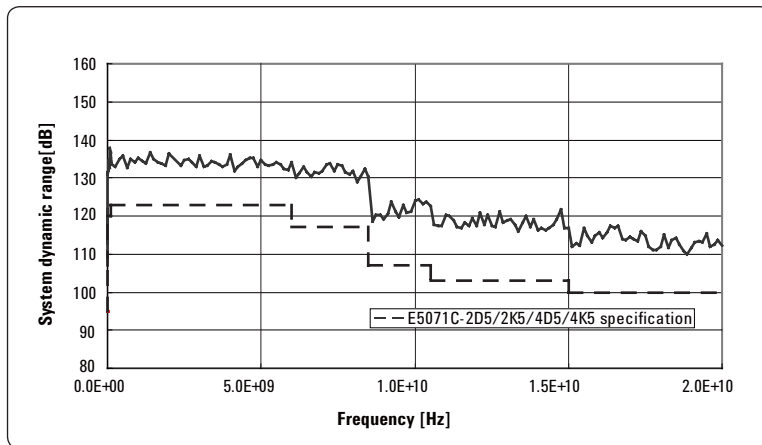

Figure 2. System dynamic range (specification and actual measurement data example, IF bandwidth 10 Hz)

1. The test port dynamic range is calculated as the difference between the test port's rms noise floor and the source's maximum output power. Effective dynamic range must take measurement uncertainty and interfering signals into account.
2. The specification might not be met at 5 MHz or 50 MHz.

Corrected system performance with calibration kit

Option 230/235/240/245/260/265/280/285/430/435/440/445/460/465/480/485

Table 3. Corrected system performance with type-N device connectors, 85032F calibration kit

Network analyzer: E5071C
 Calibration kit: 85032F (Type-N, 50 Ω)
 Calibration: full 2-port

IF bandwidth = 10 Hz, no averaging applied to data, environmental temperature = 23 °C (±5 °C) with < 1 °C deviation from calibration temperature, isolation calibration performed

Description	Specification (dB)				
	9 kHz to 300 kHz	300 kHz to 10 MHz	10 MHz to 3 GHz	3 GHz to 6 GHz	6 GHz to 8.5 GHz
Directivity	49	49	46	40	38
Source match	41	41	40	36	35
Load match	49	49	46	40	37
Reflection tracking	±0.011	±0.011	±0.021	±0.032	±0.054
Transmission tracking	±0.027	±0.015	±0.018	±0.056	±0.088

Transmission uncertainty (specification)

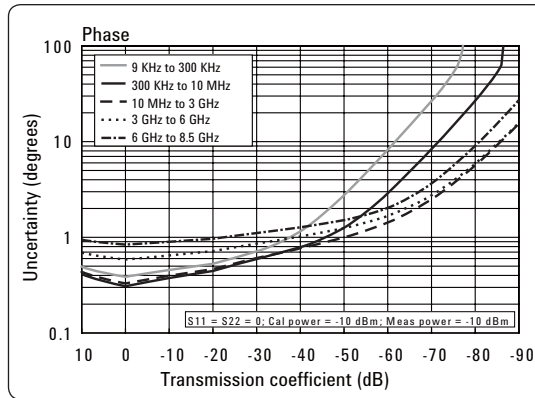
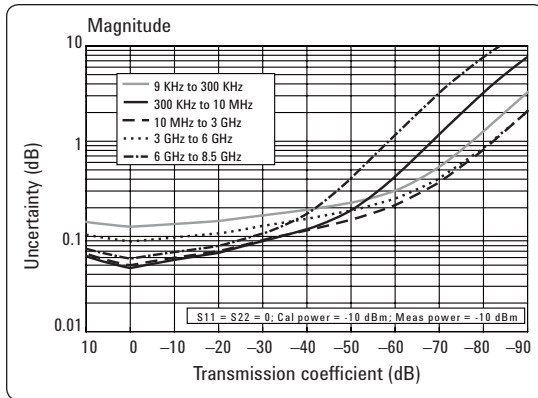

Reflection uncertainty (specification)

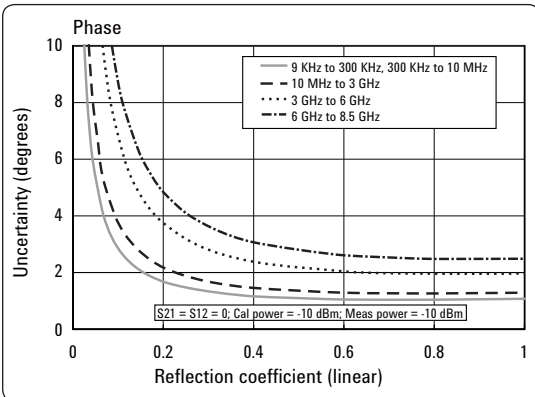
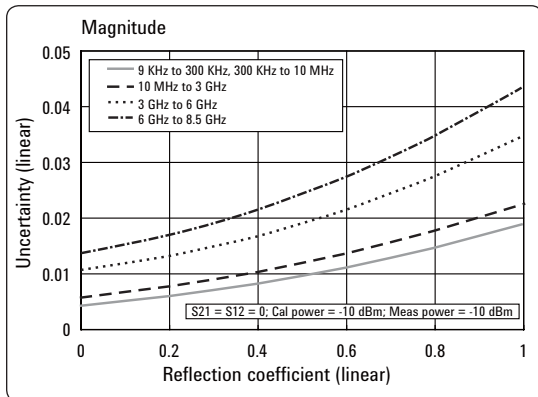

Table 4. Corrected system performance with type-N device connectors, 85092C electronic calibration (ECal) module

Network analyzer: E5071C
 Calibration module: 85092C (Type-N, 50 Ω) Electronic calibration (ECal) module
 Calibration: full 2-port

IF bandwidth = 10 Hz, no averaging applied to data, environmental temperature = 23 °C (±5 °C) with < 1 °C deviation from calibration temperature, isolation calibration performed

Description	Specification (dB)			
	300 kHz to 10 MHz	10 MHz to 3 GHz	3 GHz to 6 GHz	6 GHz to 8.5 GHz
Directivity	45	52	52	47
Source match	36	44	41	36
Load match	41	47	44	39
Reflection tracking	±0.100	±0.040	±0.060	±0.070
Transmission tracking	±0.055	±0.039	±0.068	±0.136

Transmission uncertainty (specification)

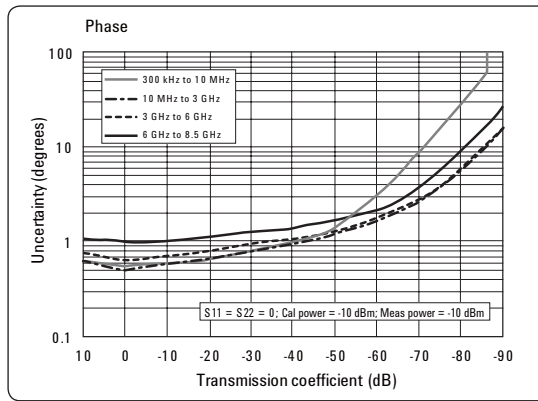
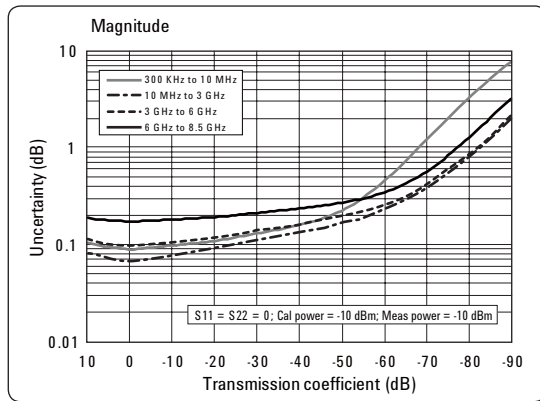

Reflection uncertainty (specification)

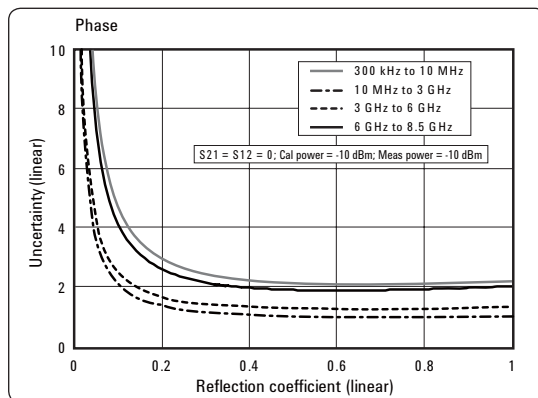
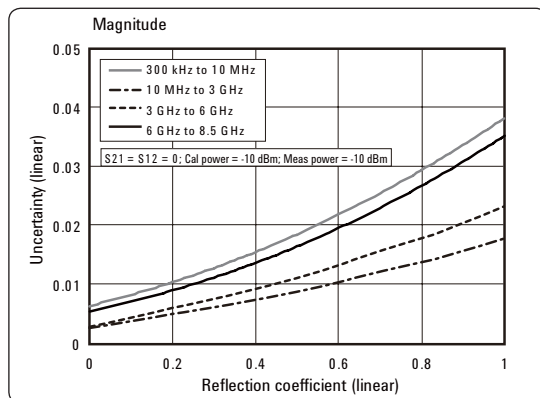

Table 5. Corrected system performance with 3.5 mm device connector type, 85033E calibration kit

Network analyzer: E5071C
 Calibration kit: 85033E (3.5 mm, 50 Ω)
 Calibration: full 2-port

IF bandwidth = 10 Hz, no averaging applied to data, environmental temperature = 23 °C (±5 °C) with < 1 °C deviation from calibration temperature, isolation calibration performed

Description	Specification (dB)				
	9 kHz to 300 kHz	300 kHz to 10 MHz	10 MHz to 3 GHz	3 GHz to 6 GHz	6 GHz to 8.5 GHz
Directivity	46	46	44	38	38
Source match	43	43	40	37	36
Load match	46	46	44	38	38
Reflection tracking	±0.006	±0.006	±0.007	±0.009	±0.010
Transmission tracking	±0.026	±0.015	±0.020	±0.058	±0.079

Transmission uncertainty (specification)

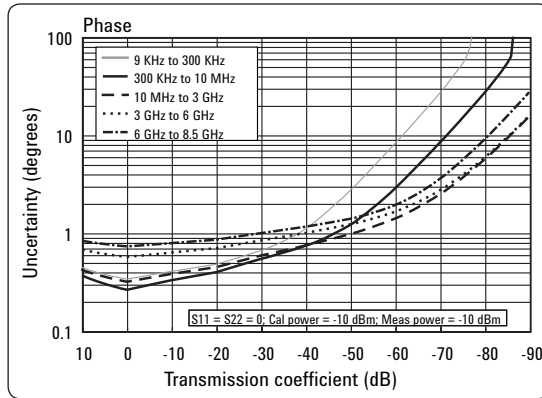
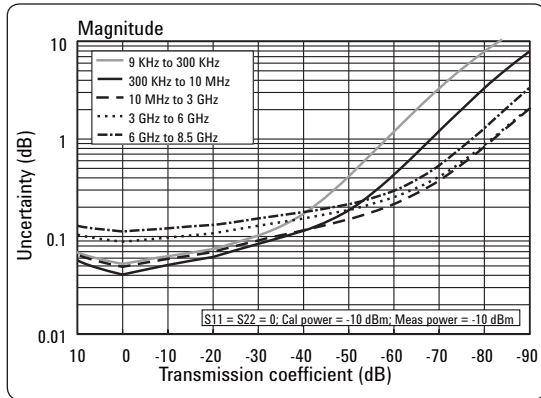

Reflection uncertainty (specification)

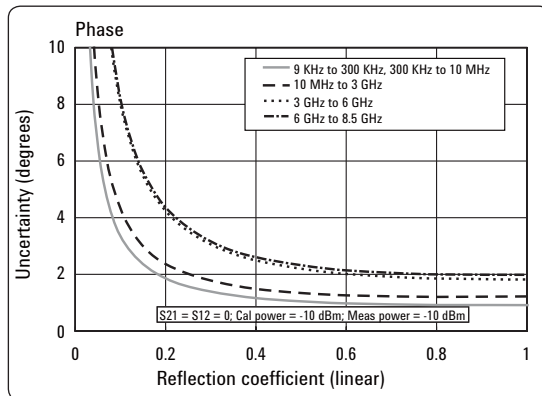
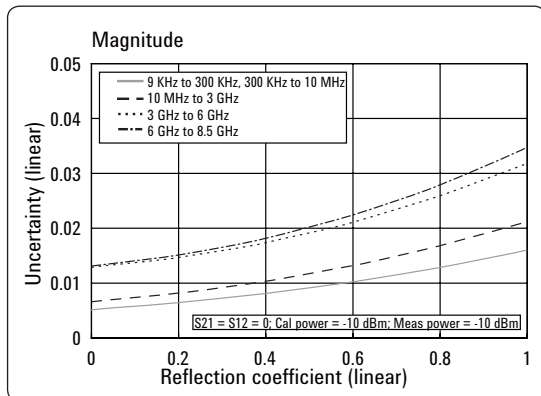

Table 6. Corrected system performance with 3.5 mm device connector type, 85093C electronic calibration (ECal) module

Network analyzer: E5071C
 Calibration module: 85093C (3.5 mm, 50 Ω) electronic calibration (ECal) module
 Calibration: full 2-port

IF bandwidth = 10 Hz, no averaging applied to data, environmental temperature = 23 °C (±5 °C) with < 1 °C deviation from calibration temperature, isolation calibration performed

Description	Specification (dB)			
	300 kHz to 10 MHz	10 MHz to 3 GHz	3 GHz to 6 GHz	6 GHz to 8.5 GHz
Directivity	45	52	51	47
Source match	36	44	39	34
Load match	41	47	44	40
Reflection tracking	±0.100	±0.040	±0.050	±0.070
Transmission tracking	±0.055	±0.049	±0.068	±0.117

Transmission uncertainty (specification)

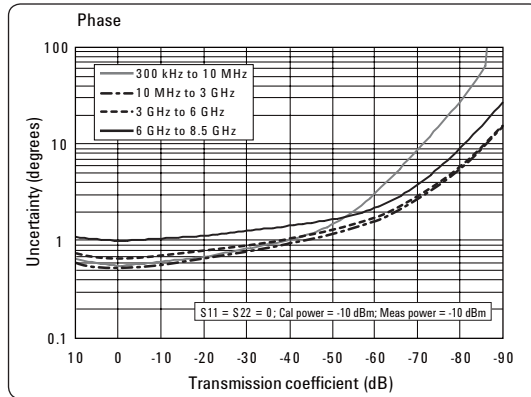
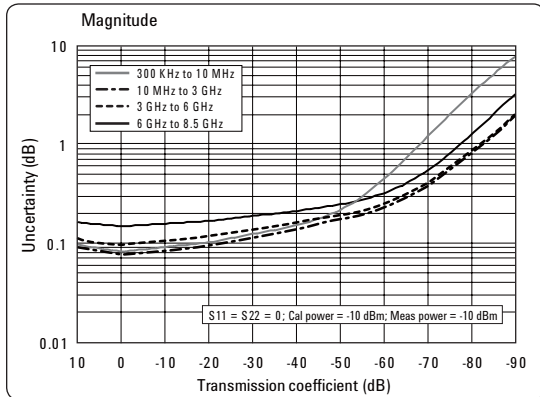

Reflection uncertainty (specification)

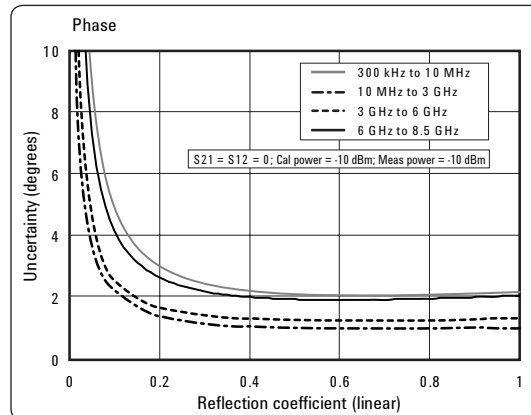
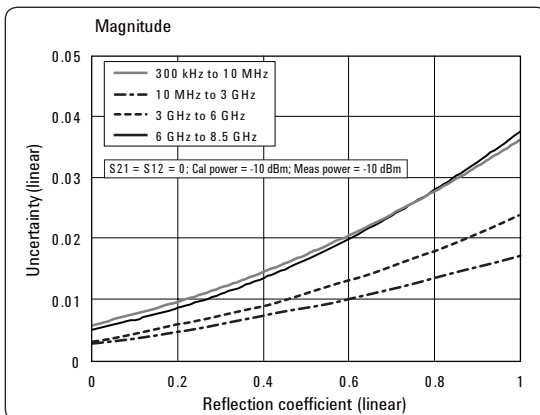

Option 2D5/2K5/4D5/4K5

Table 7. Corrected system performance with 3.5 mm device connectors, 85052D calibration kit

Network analyzer: E5071C
 Calibration kit: 85052D (3.5 mm, 50 Ω)
 Calibration: full 2-port

IF bandwidth = 10 Hz, no averaging applied to data, environmental temperature = 23 °C (±5 °C) with < 1 °C deviation from calibration temperature, isolation calibration performed

Description	Specification (dB)			
	300 kHz to 500 MHz	500 MHz to 2 GHz	2 GHz to 6 GHz	6 GHz to 20 GHz
Directivity	42	42	38	36
Source match	37	37	31	28
Load match	42	42	38	36
Reflection tracking	±0.003	±0.003	±0.004	±0.008
Transmission tracking	±0.068	±0.034	±0.100	±0.208

Transmission uncertainty (specification)

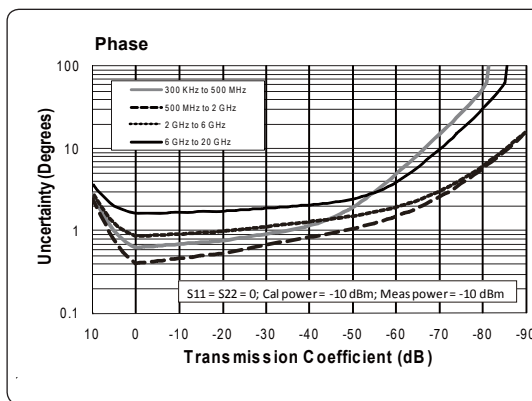
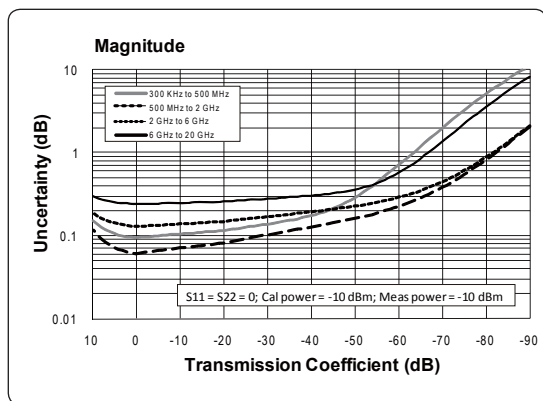

Reflection uncertainty (specification)

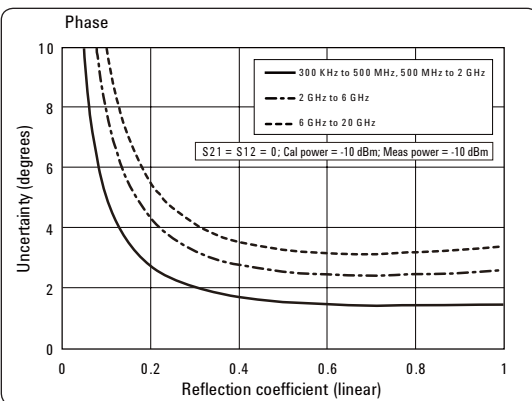
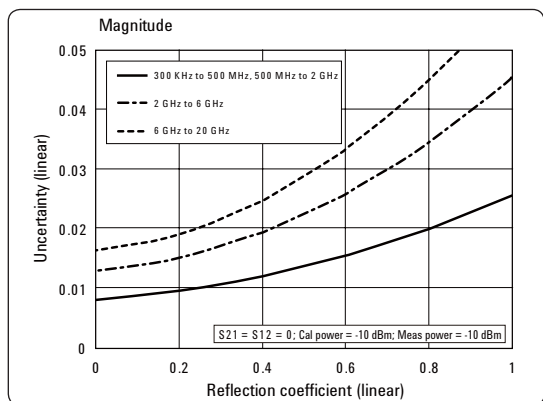

Table 8. Corrected system performance with 3.5 mm device connectors, N4691B electronic calibration (ECal) module

Network analyzer: E5071C
 Calibration module: N4691B (3.5 mm, 50 Ω) electronic calibration (ECal) module
 Calibration: full 2-port

IF bandwidth = 10 Hz, no averaging applied to data, environmental temperature = 23 °C (±5 °C) with < 1 °C deviation from calibration temperature, isolation calibration performed

Description	Specification (dB)			
	10 MHz to 500 MHz	500 MHz to 2 GHz	2 GHz to 6 GHz	6 GHz to 20 GHz
Directivity	46	56	54	48
Source match	41	47	45	44
Load match	38	41	39	36
Reflection tracking	±0.050	±0.020	±0.030	±0.040
Transmission tracking	±0.087	±0.086	±0.097	±0.130

Transmission uncertainty (specification)

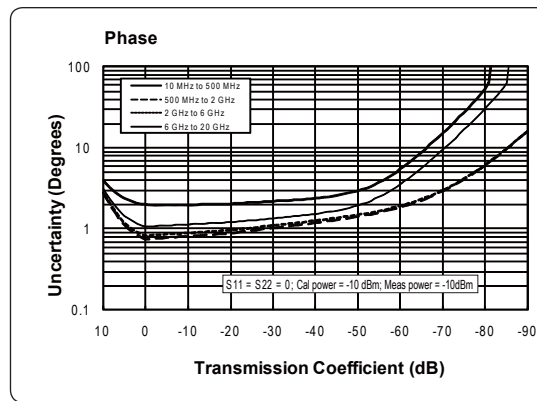
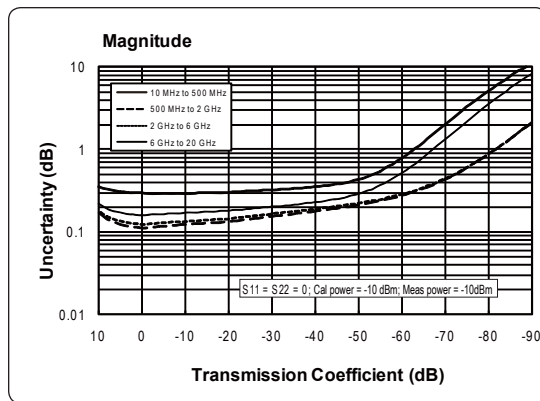

Reflection uncertainty (specification)

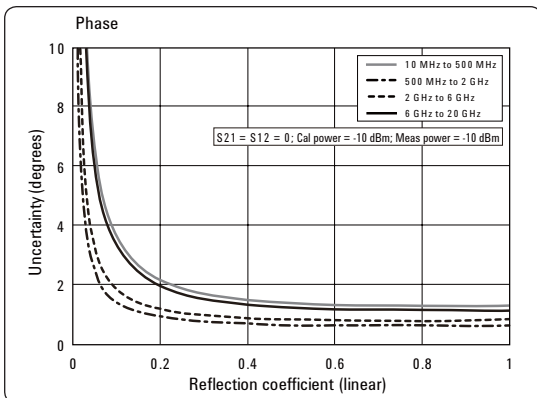
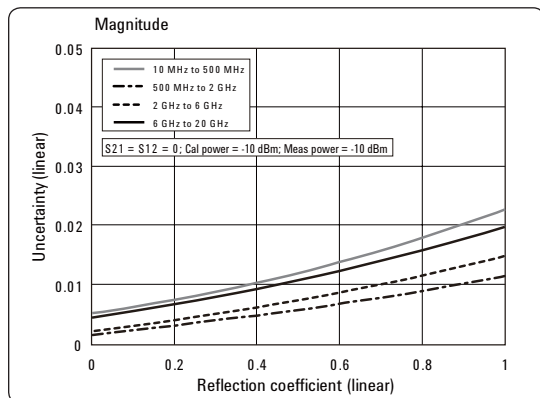

Uncorrected System Performance

Table 9. Option 230/235/240/245/260/265/280/285/430/435/440/445/460/465/480/485

User correction: OFF, system correction: ON

Description	Specification (dB)			
	9 kHz to 300 kHz	300 kHz to 3 GHz	3 GHz to 6 GHz	6 GHz to 8.5 GHz
Directivity	20 dB	25 dB	20 dB	15 dB
Source match	20 dB	25 dB	20 dB	15 dB
Load match	12 dB	17 dB	12 dB	10 dB
Transmission tracking	±1.5 dB	±1.0 dB	±1.0 dB	±1.0 dB
Reflection tracking	±1.5 dB	±1.0 dB	±1.0 dB	±1.0 dB

Table 10. Option 2D5/2K5/4D5/4K5

User correction: OFF, system correction: ON

Description	Specification (dB)						
	300 kHz to 1 MHz	1 MHz to 1 GHz	1 GHz to 3 GHz	3 GHz to 6 GHz	6 GHz to 8.5 GHz	8.5 GHz to 11 GHz	11 GHz to 20 GHz
Directivity	20 dB	25 dB	25 dB	20 dB	15 dB	15 dB	15 dB
Source match	20 dB	25 dB	25 dB	20 dB	15 dB	15 dB	15 dB
Load match	9 dB	17 dB	15 dB	11 dB	9 dB	8 dB	7 dB
Transmission tracking	±1.0 dB	±1.0 dB	±1.0 dB	±1.0 dB	±1.0 dB	±1.0 dB	±1.0 dB
Reflection tracking	±1.0 dB	±1.0 dB	±1.0 dB	±1.0 dB	±1.0 dB	±1.0 dB	±1.0 dB

Test Port Output (Source)

Test port output frequency

Table 11. Option 230/235/240/245/260/265/280/285/430/435/440/445/460/465/480/485/2D5/2K5/4D5/4K5

Description	Specification	Typical
Frequency range		
Option 230/430	9 kHz to 3 GHz	
Option 240/440	9 kHz to 4.5 GHz	
Option 260/460	9 kHz to 6.5 GHz	
Option 280/480	9 kHz to 8.5 GHz	
Option 235/435	100 kHz to 3 GHz	
Option 245/445	100 kHz to 4.5 GHz	
Option 265/465	100 kHz to 6.5 GHz	
Option 285/485	100 kHz to 8.5 GHz	
Option 2D5/4D5	300 kHz to 14 GHz	
Option 2K5/4K5	300 kHz to 20 GHz	
Resolution		
	1 Hz	
Source stability		
standard		±5 ppm (5 to 40 °C)
Option 1E5		±0.05 ppm (5 to 40 °C), ±0.5 ppm/year
CW accuracy		
standard	±5 ppm	
Option 1E5	±1 ppm	

Test port output power¹

Table 12. Option 230/235/240/245/260/265/280/285/430/435/440/445/460/465/480/485

Description	Specification	Typical
Nominal power (preset power)	0 dBm	
Level accuracy ^{2, 6} (stepped sweep mode)	±0.650 dB (at 0 dBm, 50 MHz absolute) ±1.0 dB	
Level accuracy ² (swept sweep mode)		±2.5 dB
Level linearity ^{3, 5, 6} (stepped sweep mode)		
9 kHz to 5 GHz	±0.75 dB (–20 to 10 dBm)	
5 GHz to 6 GHz	±0.75 dB (–20 to 9 dBm)	
6 GHz to 7 GHz	±0.75 dB (–20 to 8 dBm)	
7 GHz to 8.5 GHz	±0.75 dB (–20 to 7 dBm)	
Level linearity ⁵ (swept sweep mode) ⁴		
9 kHz to 5 GHz		±1.5 dB (at –20 to 10 dBm)
5 GHz to 6 GHz		±1.5 dB (at –20 to 9 dBm)
6 GHz to 7 GHz		±1.5 dB (at –20 to 8 dBm)
7 GHz to 8.5 GHz		±1.5 dB (at –20 to 7 dBm)
Range ^{5, 6}		
9 kHz to 5 GHz	–55 to 10 dBm	
5 GHz to 6 GHz	–55 to 9 dBm	
6 GHz to 7 GHz	–55 to 8 dBm	
7 GHz to 8.5 GHz	–55 to 7 dBm	
Sweep range ^{5, 6}		
9 kHz to 5 GHz	–55 to 10 dBm	
5 GHz to 6 GHz	–55 to 9 dBm	
6 GHz to 7 GHz	–55 to 8 dBm	
7 GHz to 8.5 GHz	–55 to 7 dBm	
Level resolution	0.05 dB	
Description	Specification	SPD
Max leveled power ^{5, 6} (Option 230/235/240/245/260/265/280/285)		
9 kHz to 8.5 GHz		10 dBm
(Option 430/435/440/445/460/465/480/485)		
9 kHz to 6 GHz		10 dBm
6 GHz to 7 GHz		9 dBm
7 GHz to 8.5 GHz		8 dBm

1. Source output performance on port 1 only. Other port output performance is typical.
2. Level accuracy is taken at 0 dBm, relative to 50 MHz reference unless otherwise stated.
3. Level linearity given is relative to 0 dBm.
4. The specification might not be met at 5 MHz or 50 MHz.
5. The level accuracy specification needs to be taken into account for test port output power level.
6. Power calibration using an external power meter improves level accuracy of the test port output power. Proper power meters/sensors, and the 82357B USB-GPIB interface are required to conduct power calibration.

Test port output power⁷ (continued)

Table 13. Option 2D5/2K5/4D5/4K5

Description	Specification	Typical
Nominal power (preset power)	-5 dBm	
Level accuracy ⁶ (stepped sweep mode) ¹	±0.650 dB	
300 kHz to 1 MHz	+2.0 dB, -6.0 dB	
1 MHz to 5 MHz	±2.0 dB	
5 MHz to 8.5 GHz	±1.0 dB	
8.5 GHz to 20 GHz	±2.5 dB	
Level accuracy (swept sweep mode) ²		
300 kHz to 1 GHz		±5.0 dB
1 GHz to 8.5 GHz		±2.5 dB
8.5 GHz to 20 GHz		+5.0 dB, -7.0 dB
Level linearity ^{5, 6} (stepped sweep mode) ³		
300 kHz to 1 MHz	±0.75 dB (-25 to 8 dBm)	
1 MHz to 6 GHz	±0.75 dB (-25 to 10 dBm)	
6 GHz to 8 GHz	±0.75 dB (-25 to 9 dBm)	
8 GHz to 10.5 GHz	±0.75 dB (-25 to 7 dBm)	
10.5 GHz to 15 GHz	±0.75 dB (-25 to 3 dBm)	
15 GHz to 20 GHz	±0.75 dB (-25 to 0 dBm)	
Level linearity ⁵ (swept sweep mode) ³		
300 kHz to 1 MHz		±1.5 dB (-25 to 8 dBm)
1 MHz to 6 GHz		±1.5 dB (-25 to 10 dBm)
6 GHz to 8 GHz		±1.5 dB (-25 to 9 dBm)
8 GHz to 10.5 GHz		±1.5 dB (-25 to 7 dBm)
10.5 GHz to 15 GHz		±1.5 dB (-25 to 3 dBm)
15 GHz to 20 GHz		±1.5 dB (-25 to 0 dBm)
Range ^{5, 6}		
300 kHz to 1 MHz	-85 to 8 dBm	
1 MHz to 6 GHz	-85 to 10 dBm	
6 GHz to 8 GHz	-85 to 9 dBm	
8 GHz to 10.5 GHz	-85 to 7 dBm	
10.5 GHz to 15 GHz	-85 to 3 dBm	
15 GHz to 20 GHz	-85 to 0 dBm	
Sweep range ^{4, 5, 6}		
300 kHz to 1 MHz	-25 to 8 dBm	
1 MHz to 6 GHz	-25 to 10 dBm	
6 GHz to 8 GHz	-25 to 9 dBm	
8 GHz to 10.5 GHz	-25 to 7 dBm	
10.5 GHz to 15 GHz	-25 to 3 dBm	
15 GHz to 20 GHz	-25 to 0 dBm	
(Source attenuator = 0 dB)		
Level resolution	0.05 dB	

1. Level accuracy is taken at -5 dBm, relative to 50 MHz reference unless otherwise stated.
2. Level accuracy is taken at -5 dBm, relative to 50 MHz reference.
3. Level linearity given is relative to -5 dBm.
4. The sweep range shifts based on the selected source attenuator value (0 dB to 60 dB, 10 dB step).
5. The level accuracy specification needs to be taken into account for test port output power level.
6. Power calibration using an external power meter improves level accuracy of the test port output power. Proper power meters/sensors, and the 82357B USB-GPIB interface are required to conduct power calibration.
7. Source output performance on port 1 only. Other port output performance is typical.

Test port output power⁶ (continued)

Table 13. Option 2D5/2K5/4D5/4K5

Description	Specification	SPD
Max leveled power ^{3, 4}		
300 kHz to 1 MHz		9 dBm
1 MHz to 10 GHz		10 dBm
10 GHz to 13 GHz		9 dBm
13 GHz to 15 GHz		7 dBm
15 GHz to 18 GHz		5 dBm
18 GHz to 20 GHz		4 dBm

Test port output signal purity

Table 14. Option 230/235/240/245/260/265/280/285/430/435/440/445/460/465/480/485

Description	Specification	Typical
Harmonics (2nd or 3rd)		
9 kHz to 2 GHz		< -25 dBc (at 5 dBm)
2 GHz to 8.5 GHz		< -20 dBc (at 5 dBm)
Non-harmonic spurious		
9 kHz to 8.5 GHz		< -30 dBc (at 5 dBm)

Table 15. Option 2D5/2K5/4D5/4K5

Description	Specification	Typical
Harmonics (2nd to 5th) ¹		
300 kHz to 1 GHz		< -12 dBc (at maximum output power) ⁵
1 GHz to 20 GHz		< -15 dBc (at maximum output power) ⁵
Non-harmonic spurious ²		
300 kHz to 20 GHz		< -30 dBc (at -5 dBm)

1. This includes 6th and 7th harmonics when the test frequency is from 1 MHz to 1 GHz.
2. The carrier $\pm 1/8$ th spurious is excluded from 8.76 GHz to 17.52 GHz.
3. The level accuracy specification needs to be taken into account for test port output power level.
4. Power calibration using an external power meter improves level accuracy of the test port output power. Proper power meters/sensors, and the 82357B USB-GPIB interface are required to conduct power calibration.
5. Maximum output power is the maximum power of "Range" in Table 13 Test port output power.
6. Source output performance on port 1 only. Other port output performance is typical.

Test Port Input

Test port input levels

Table 16. Option 230/235/240/245/260/265/280/285/430/435/440/445/460/465/480/485

Description	Specification	Typical
Maximum test port input level		
9 kHz to 5 GHz	+10 dBm	
5 GHz to 6 GHz	+9 dBm	
6 GHz to 7 GHz	+8 dBm	
7 GHz to 8.5 GHz	+7 dBm	
Damage level		
9 kHz to 8.5 GHz		+26 dBm ±35 VDC
Crosstalk¹		
9 kHz to 300 kHz	-100 dB	
300 kHz to 10 MHz	-110 dB	
10 MHz to 3 GHz	-120 dB	
3 GHz to 6 GHz	-110 dB	
6 GHz to 8.5 GHz	-100 dB	
Description	Specification	SPD
Test port noise floor		
9 kHz to 10 MHz		-115 dBm/Hz
10 MHz to 5 GHz		-130 dBm/Hz
5 GHz to 6 GHz		-131 dBm/Hz
6 GHz to 7 GHz		-130 dBm/Hz
7 GHz to 8 GHz		-129 dBm/Hz
8 GHz to 8.5 GHz		-127 dBm/Hz

1. The specification might not be met at 5 MHz or 50 MHz.

Test port input levels *(continued)*

Table 17. Option 2D5/2K5/4D5/4K5

Description	Specification	Typical
Maximum test port input level		
300 kHz to 20 GHz	+10 dBm	
Damage level		
300 kHz to 20 GHz		+26 dBm or ± 35 VDC
Crosstalk¹		
300 kHz to 1 MHz	-68 dB	
1 MHz to 5 MHz	-70 dB	
5 MHz to 10 MHz	-100 dB	
10 MHz to 45 MHz	-110 dB	
45 MHz to 4 GHz	-118 dB	
4 GHz to 6 GHz	-123 dB	
6 GHz to 8.5 GHz	-120 dB	
8.5 GHz to 15 GHz	-112 dB	
15 GHz to 20 GHz	-106 dB	
Description	Specification	SPD
Test port noise floor		
300 kHz to 1 MHz		-110 dBm/Hz
1 MHz to 10 MHz		-115 dBm/Hz
10 MHz to 100 MHz		-129 dBm/Hz
100 MHz to 8.5 GHz		-130 dBm/Hz
8.5 GHz to 15 GHz		-118 dBm/Hz
15 GHz to 20 GHz		-115 dBm/Hz

1. The specification might not be met at 5 MHz or 50 MHz.

Test port input (trace noise)

Table 18. Option 230/235/240/245/260/265/280/285/430/435/440/445/460/465/480/485

Description	Specification	SPD
Compression level		
Magnitude		
9 kHz to 5 GHz		0.08 dB
5 GHz to 8.5 GHz		0.1 dB
(maximum test port input level = +10 dBm)		
Phase		
9 kHz to 3 GHz		0.3 deg
3 GHz to 5 GHz		0.6 deg
5 GHz to 8.5 GHz		1.0 deg
(maximum test port input level = +10 dBm)		
Trace noise magnitude¹		
9 kHz to 30 kHz (IFBW = 3 kHz)	0.004 dBrms	0.001 dBm
(maximum test port input level = +10 dBm)		
30 kHz to 100 kHz (IFBW = 3 kHz)	0.003 dBm	0.001 dBm
(maximum test port input level = +10 dBm)		
100 kHz to 10 MHz (IFBW = 3 kHz)	0.003 dBrms	0.0005 dBm
(maximum test port input level = +10 dBm)		
10 MHz to 4.38 GHz (IFBW = 70 kHz)	0.004 dBrms	0.001 dBrms
(maximum test port input level = +10 dBm)		
4.38 GHz to 5 GHz (IFBW = 70 kHz)	0.006 dBrms	0.0012 dBm
(maximum test port input level = +10 dBm)		
5 GHz to 6 GHz (IFBW = 70 kHz)	0.006 dBrms	0.0012 dBm
(maximum test port input level = +9 dBm)		
6 GHz to 7 GHz (IFBW = 70 kHz)	0.006 dBrms	0.0012 dBm
(maximum test port input level = +8 dBm)		
7 GHz to 8.5 GHz (IFBW = 70 kHz)	0.006 dBrms	0.0012 dBm
(maximum test port input level = +7 dBm)		
Trace noise phase²		
9 kHz to 30 kHz (IFBW = 3 kHz)	0.035 deg rms	
(maximum test port input level = +10 dBm)		
30 kHz to 10 MHz (IFBW = 3 kHz)	0.020 deg rms	
(maximum test port input level = +10 dBm)		
10 MHz to 4.38 GHz (IFBW = 70 kHz)	0.035 deg rms	
(maximum test port input level = +10 dBm)		
4.38 GHz to 5 GHz (IFBW = 70 kHz)	0.050 deg rms	
(maximum test port input level = +10 dBm)		
5 GHz to 6 GHz (IFBW = 70 kHz)	0.050 deg rms	
(maximum test port input level = +9 dBm)		
6 GHz to 7 GHz (IFBW = 70 kHz)	0.050 deg rms	
(maximum test port input level = +8 dBm)		
7 GHz to 8.5 GHz (IFBW = 70 kHz)	0.050 deg rms	
(maximum test port input level = +7 dBm)		

1. The specification might not be met at the following frequencies: 333.333 kHz, 406.25 kHz, 857.143 kHz, 928.571 kHz, 1.3 MHz, 2.4 MHz and 4.333333 MHz.

2. The specification might not be met at 5 MHz or 50 MHz.

Test port input (trace noise) *(continued)*

Table 19. Option 2D5/2K5/4D5/4K5

Description	Specification	SPD
Compression level		
Magnitude		
300 kHz to 10 MHz		0.3 dB
10 MHz to 10 GHz		0.182 dB
10 GHz to 15 GHz		0.712 dB
15 GHz to 20 GHz		1.87 dB
(maximum test port input level = +10 dBm)		
Phase		
300 kHz to 5 GHz		2.3 deg
5 GHz to 10 GHz		4.3 deg
10 GHz to 15 GHz		17.3 deg
15 GHz to 20 GHz		20.3 deg
(maximum test port input level = +10 dBm)		
Trace noise magnitude^{1, 3}		
300 kHz to 1 MHz (IFBW = 3 kHz)	0.006 dBrms	0.0009 dBrms
1 MHz to 10 MHz (IFBW = 3 kHz)	0.003 dBrms	0.0005 dBrms
10 MHz to 4.38 GHz (IFBW = 70 kHz)	0.004 dBrms	0.0010 dBrms
4.38 GHz to 8.5 GHz (IFBW = 70 kHz)	0.006 dBrms	0.0012 dBrms
8.5 GHz to 13.137 GHz (IFBW = 70 kHz)	0.009 dBrms	0.0024 dBrms
13.137 GHz to 17 GHz (IFBW = 70 kHz)	0.013 dBrms	0.0040 dBrms
17 GHz to 20 GHz (IFBW = 70 kHz)	0.023 dBrms	0.0065 dBrms
(at maximum output power level of sweep range)		
Trace noise phase^{2, 3}		
300 kHz to 1 MHz (IFBW = 3 kHz)	0.040 deg rms	0.0120 deg rms
1 MHz to 10 MHz (IFBW = 3 kHz)	0.020 deg rms	0.0025 deg rms
10 MHz to 4.38 GHz (IFBW = 70 kHz)	0.035 deg rms	0.0075 deg rms
4.38 GHz to 8.5 GHz (IFBW = 70 kHz)	0.050 deg rms	0.0150 deg rms
8.5 GHz to 13.137 GHz (IFBW = 70 kHz)	0.064 deg rms	0.0250 deg rms
13.137 GHz to 17 GHz (IFBW = 70 kHz)	0.095 deg rms	0.0320 deg rms
17 GHz to 20 GHz (IFBW = 70 kHz)	0.165 deg rms	0.0520 deg rms
(at maximum output power level of sweep range)		

1. The specification might not be met at the following frequencies: 406.25 kHz, 666.667 kHz, 722.222 kHz, 857.143 kHz, 928.571 kHz, 1.444444 MHz, 1.714286 MHz, 1.8 MHz, 1.857143 MHz, 1.95 MHz, 2.4375 MHz, 2.571429 MHz, 3.714286 MHz, 4.8 MHz, 5 MHz, 5.416667 MHz, 7.583333 MHz, 10 MHz, 10.833333 MHz, 12.5 MHz.

2. The specification might not be met at 5 MHz or 50 MHz.

3. Trace noise SPD is defined with transmission measurements only.

Test port input (stability)¹

Table 20. Option 230/235/240/245/260/265/280/285/430/435/440/445/460/465/480/485

Description	Specification	Typical
Stability magnitude		
9 kHz to 3 GHz		±0.005 dB/°C
3 GHz to 6 GHz		±0.01 dB/°C
6 GHz to 8.5 GHz		±0.04 dB/°C
Stability phase		
9 kHz to 3 GHz		±0.1 deg/°C
3 GHz to 6 GHz		±0.2 deg/°C
6 GHz to 8.5 GHz		±0.8 deg/°C

Table 21. Option 2D5/2K5/4D5/4K5

Description	Specification	Typical
Stability magnitude		
300 kHz to 3 GHz		±0.005 dB/°C
3 GHz to 6 GHz		±0.01 dB/°C
6 GHz to 20 GHz		±0.04 dB/°C
Stability phase		
300 kHz to 3 GHz		±0.1 deg/°C
3 GHz to 6 GHz		±0.2 deg/°C
6 GHz to 20 GHz		±0.8 deg/°C

1. Stability is defined as a ratio measurement at the test port.

Test port input (dynamic accuracy)

Table 22. Option 230/235/240/245/260/265/280/285/430/435/440/445/460/465/480/485

Accuracy of the test port input power reading is relative to -10 dBm reference input power level.

Description	Specification	Typical
Dynamic accuracy magnitude		
10 dBm	± 0.21 dB	
-30 dBm	± 0.05 dB	
-100 dBm	± 2.01 dB	
Dynamic accuracy phase		
10 dBm		± 5 deg
-30 dBm		± 0.3 deg
-100 dBm		± 15.1 deg

Specification

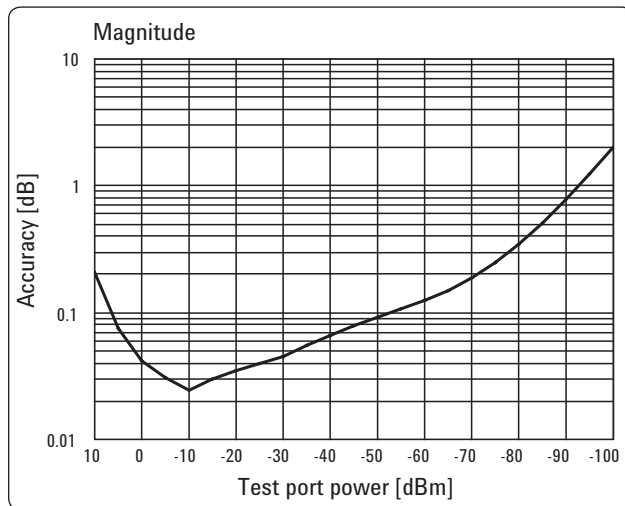

Typical

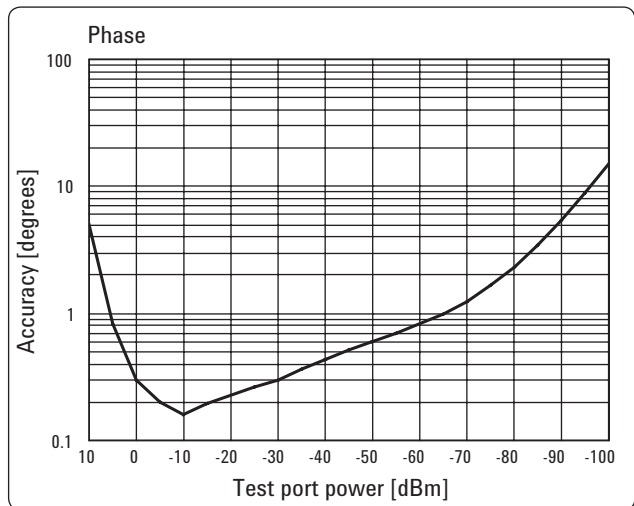

± 3.0 dB (at -110 dBm, Ref. = -10 dBm, typical)

Test port input (dynamic accuracy) (continued)

Table 23. Option 2D5/2K5/4D5/4K5

Accuracy of the test port input power reading is relative to -10 dBm reference input power level.

Description	Specification	Typical
Dynamic accuracy magnitude		
10 dBm	± 2.4972 dB	
-30 dBm	± 0.05 dB	
-100 dBm	± 2.01 dB	
Dynamic accuracy phase		
10 dBm		± 20.66 deg
-30 dBm		± 0.3 deg
-100 dBm		± 15.1 deg

Specification

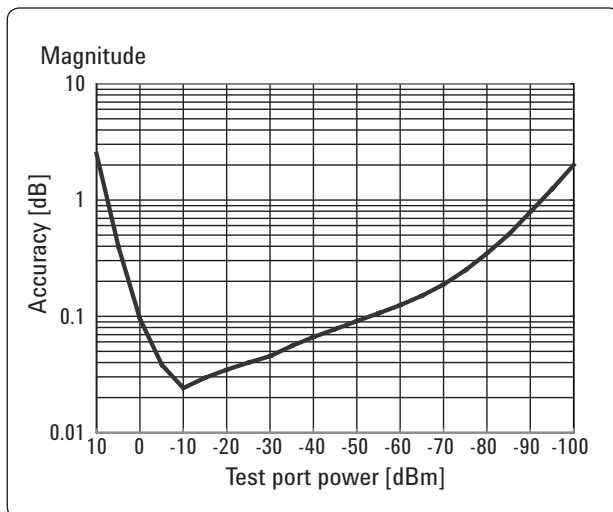

Typical

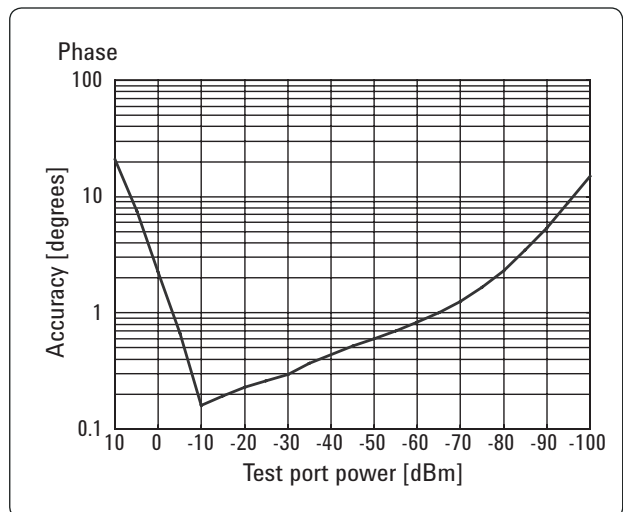

± 3.0 dB (at -110 dBm, Ref. = -10 dBm, typical)

Test port input (group delay)¹

Table 24. Option 230/235/240/245/260/265/280/285/430/435/440/445/460/465/480/485

Description	Specification	Supplemental information
Aperture (selectable)	(frequency span)/(number of points - 1)	
Maximum aperture	25% of frequency span	
Minimum delay		Limited to measuring no more than 180 °C of phase change within the minimum aperture.
Accuracy		See graph below, typical

The following graph shows group delay accuracy with type-N connectors, full 2-port calibration and a 10 Hz IF bandwidth.

Calibration kit (85032F). Insertion loss is assumed to be < 2 dB.

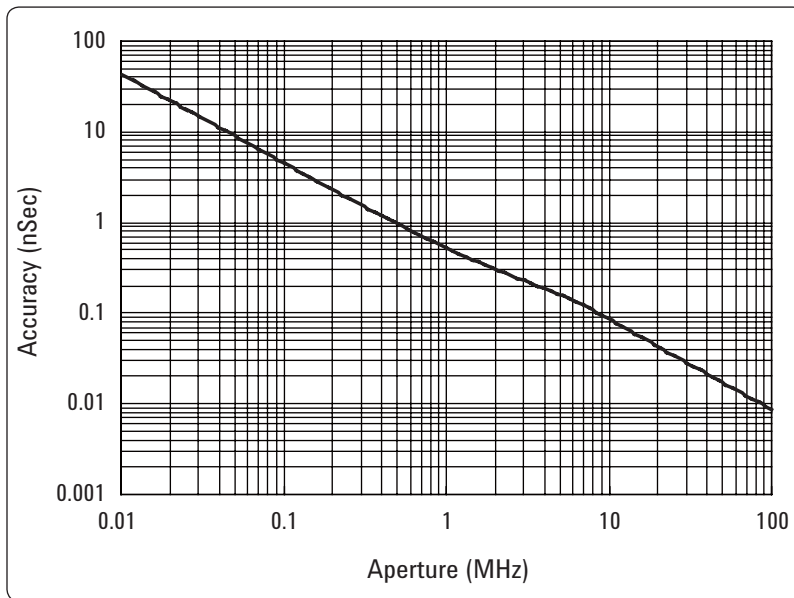

In general, the following formula can be used to determine the accuracy, in seconds, of a specific group delay measurement:

$$\pm \text{phase accuracy (degrees)} / [360 \times \text{aperture (Hz)}]$$

1. Group delay is computed by measuring the phase change within a specified step (determined by the frequency span and the number of points per sweep).

Test port input (group delay)¹ (continued)

Table 25. Option 2D5/2K5/4D5/4K5

Description	Specification	Supplemental information
Aperture (selectable)	(frequency span)/(number of points - 1)	
Maximum aperture	25% of frequency span	
Minimum delay		Limited to measuring no more than 180 °C of phase change within the minimum aperture.
Accuracy		See graph below, typical

The following graph shows group delay accuracy with 3.5 mm (male) connectors, full 2-port calibration and a 10 Hz IF bandwidth.

Calibration kit (85052D). Insertion loss is assumed to be < 2 dB.

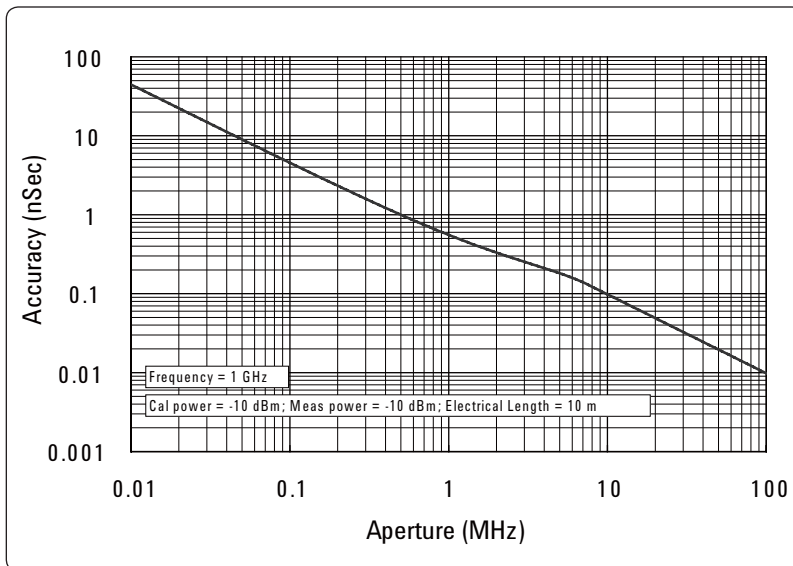

In general, the following formula can be used to determine the accuracy, in seconds, of a specific group delay measurement:

$$\pm \text{phase accuracy (degrees)} / [360 \times \text{aperture (Hz)}]$$

1. Group delay is computed by measuring the phase change within a specified step (determined by the frequency span and the number of points per sweep).

General Information

Table 26. System bandwidth

Description	General characteristics
IF bandwidth settings	
Range	10 Hz to 500 kHz Nominal settings are: 10, 15, 20, 30, 40, 50, 70, 100, 150, 200, 300, 400, 500, 700, 1 k, 1.5 k, 2 k, 3 k, 4 k, 5 k, 7 k, 10 k, 15 k, 20 k, 30 k, 40 k, 50 k, 70 k, 100 k, 150 k, 200 k, 300 k, 400 k, 500 kHz

Table 27. Front panel information

Description	Typical	General characteristics
RF connectors		
Option 230/235/240/ 245/260/265/280/285/ 430/435/440/445/460/ 465/480/485		Type-N, female, 50 Ω
Option 2D5/2K5/4D5/4K5		3.5 mm (male), 50 Ω nominal
Probe power		
Connector		3 terminal connector x 2
Voltage & maximum current	+15 V ±2% (400 mA) -12.6 V ±5% (300 mA) (Combined load for both probe connections)	
Display		
Type		10.4 in TFT color LCD with touch screen
Resolution		XGA (1024 x 768) ¹

1. Valid pixels are 99.99 % and more. Below 0.01 % (approx. 30 points) of fixed points of black, blue, green or red are not regarded as failure.

Table 28. Rear panel information

Description	Typical	General characteristics
External trigger input connector		
Type		BNC, female
Input level		Low threshold voltage: 0.5 V High threshold voltage: 2.1 V Input level range: 0 to + 5 V
Pulse width		$\geq 2 \mu\text{sec}$
Polarity		Positive or negative
External trigger output connector		
Type		BNC, female
Maximum output current		50 mA
Output level		Low level voltage: 0 V High level voltage: 5 V
Pulse width		1 μsec
Polarity		Positive or negative
External reference signal input connector		
Type		BNC, female
Input frequency	10 MHz ± 10 ppm	
Input level	-3 to + 10 dBm	
Internal reference signal output connector		
Type		BNC, female
Output frequency	10 MHz ± 5 ppm	
Signal type	Sinewave	
Output level	0 dBm ± 3 dB into 50 Ω	
Output impedance		50 Ω
Internal reference signal oven connector		
Type		BNC, female
Output frequency	10 MHz ± 1 ppm	
Output level	0 dBm minimum	

Table 28. Rear panel information *(continued)*

Description	Typical	General characteristics
Bias tee input connector		
Type		BNC, female (for each port)
Maximum voltage		±35 VDC
Maximum current (no degradation in RF specifications)		
Option 230/235/240/245/260/265/280/ 285/430/435/440/445/460/465/480/485		±50 mA (1 MHz < test frequency < 500 MHz)
		±200 mA (test frequency ≤ 1 MHz, ≥ 500 MHz)
Option 2D5/2K5/4D5/4K5		±200 mA
Maximum current (damage level)		
		±500 mA
Fuse		
		500 mA, bi-pin style
Video output		
		15-pin mini D-Sub; female; drives XGA compatible monitors
GPIB		
		24-pin D-Sub (Type D-24), female; compatible with IEEE-488
USB-host port		
	Universal serial bus jack, Type A configuration (4 contacts inline, contact 1 on left); female; provides connection to printer, ECal module, USB/GPIB interface or multiport test set	
Contact 1		Vcc: 4.75 to 5.25 VDC, 500 mA, maximum
Contact 2		– Data
Contact 3		+ Data
Contact 4		Ground

Table 28. Rear panel information *(continued)*

Description	Typical	General characteristics
USB (USBTMC¹) interface port		Universal serial bus jack, Type B configuration (4 contacts inline); female; provides connection to an external PC; compatible with USBTMC-USB488 and USB 2.0.
LAN		10/100BaseT Ethernet, 8-pin configuration; auto selects between the two data rates
Handler I/O port		36-pin centronics, female; provides connection to handler system
Line power²		
Frequency		47 Hz to 63 Hz
Voltage		90 to 132 VAC, or 198 to 264 VAC (automatically switched)
VA max		350 VA max.

Description	Specification	General characteristics
AUX input connector		
Type		BNC, female x 2
Input range		±1 V or ±10 V selectable
Accuracy	1 % + 1 mV for ±1 V input 1 % + 10 mV for ±10 V input	

Table 29. LXI compliance

Description	General characteristics
	Class C (only applies to units that are shipped with firmware revision A.08.00 or later)

1. USB Test and Measurement Class (TMC) interface that communicates over USB, complying with the IEEE 488.1 and IEEE 488.2 standards.
2. A third-wire ground is required.

Table 30. EMC, safety and environment







Description	General characteristics
EMC	
 ISM 1-A	European Council Directive 2004/108/EC IEC 61326-1:2005 EN 61326-1:2006 CISPR 11:2003+A1:2004 EN 55011:2007 Group 1, Class A IEC 61000-4-2:1995 +A2:2000 EN 61000-4-2:1995 +A2:2001 4 kV CD / 8 kV AD IEC 61000-4-3:2006 EN 61000-4-3:2006 1-3 V/m, 80-1000 MHz / 1.4 GHz - 2.7 GHz, 80% AM IEC 61000-4-4:2004 EN 61000-4-4:2004 1 kV power lines / 0.5 kV signal lines IEC 61000-4-5:2005 EN 61000-4-5:2006 0.5 kV line-line / 1 kV line-ground IEC 61000-4-6:2003 + A1:2004+ A2:2006 EN 61000-4-6:2007 3 V, 0.15-80 MHz, 80% AM IEC 61000-4-11:2004 EN 61000-4-11:2004 0.5-300 cycle, 0% / 70%
ICES/NMB-001	ICES-001:2006 Group 1, Class A
 N10149	AS/NZS CISPR11:2004 Group 1, Class A
Safety	
 ISM 1-A	European Council Directive 2006/95/EC IEC 61010-1:2001 / EN 61010-1:2001 Measurement Category I Pollution Degree 2 Indoor Use
 LR95111C	CAN/CSA C22.2 No. 61010-1-04 Measurement Category I Pollution Degree 2 Indoor Use
Environment	
 	<p>This product complies with the WEEE Directive (2002/96/EC) marking requirements. The affixed label indicates that you must not discard this electrical/electronic product in domestic household waste.</p> <p>Product Category: With reference to the equipment types in the WEEE Directive Annex I, this product is classed as a "Monitoring and Control instrumentation" product.</p> <p>Do not dispose in domestic household waste.</p> <p>To return unwanted products, contact your local Agilent office, or see www.agilent.com/environment/product/ for more information.</p>

Table 31. Analyzer environmental specifications and dimensions

Description	General characteristics
Operating environment	
Temperature	+5 °C to +40 °C
Error-corrected temperature range	23 °C (±5 °C) with < 1 °C deviation from calibration temperature
Humidity	20% to 80% at wet bulb temperature < +29 °C (non-condensation)
Altitude	0 to 2,000 m (0 to 6561 feet)
Vibration	0.21 G maximum, 5 Hz to 500 Hz
Non-Operating storage environment	
Temperature	-10 °C to +60 °C
Humidity	20% to 90% at wet bulb temperature < +40 °C (non-condensation)
Altitude	0 to 4572 m (0 to 15,000 feet)
Vibration	0.5 G maximum, 5 Hz to 500 Hz
Dimensions	See next page.
Weight (net)	
Option 230/240/260/280 (2-port)	18.2 kg
Option 235/245/265/285 (2-port)	18.3 kg
Option 430/480/440/460 (4-port)	19.9 kg
Option 435/445/465/485 (4-port)	20.0 kg
Option 2D5/2K5 (2-port)	19.8 kg
Option 4D5/4K5 (4-port)	21.8 kg

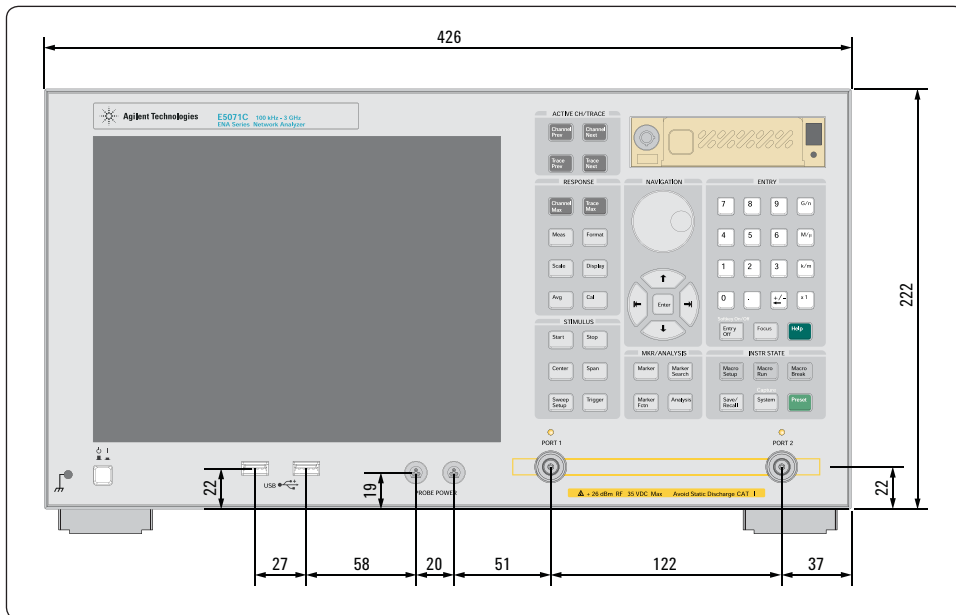

Figure 3. Dimensions (front view, E5071C with Option 230/235/240/245/260/265/280/285, in millimeters)

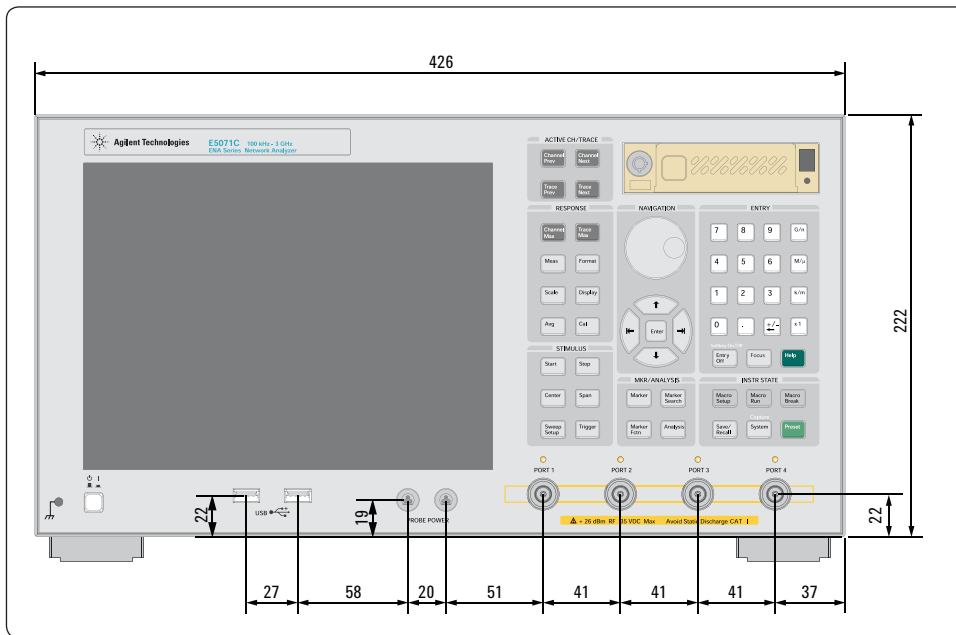

Figure 4. Dimensions (front view, E5071C with Option 430/435/440/445/460/465/480/485, in millimeters)

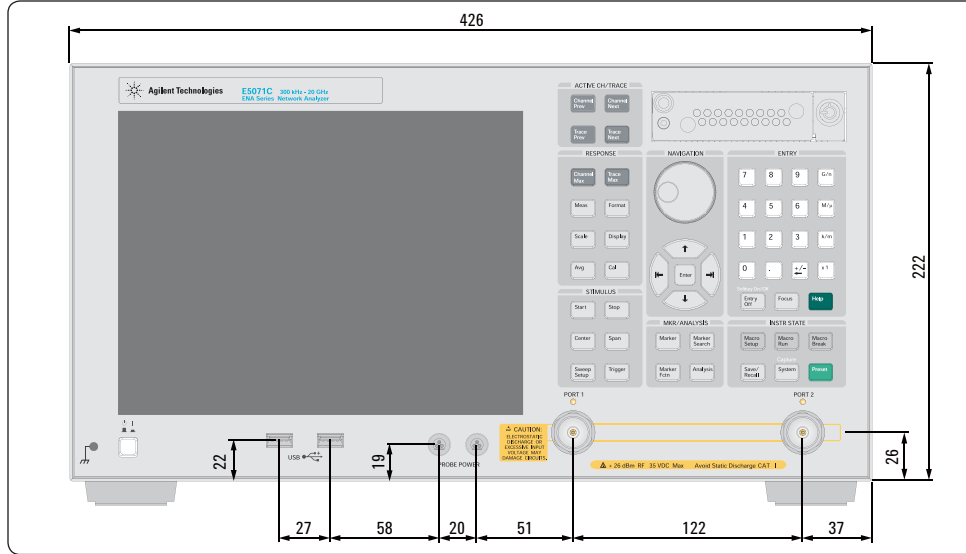

Figure 5. Dimensions (front view, E5071C with Option 2D5/2K5, in millimeters)

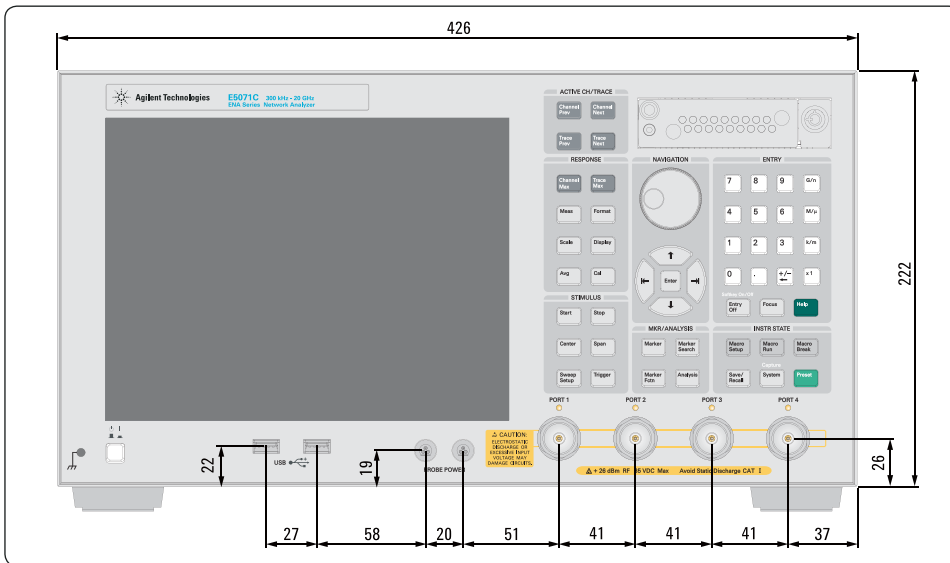

Figure 6. Dimensions (front view, E5071C with Option 4D5/4K5, in millimeters)

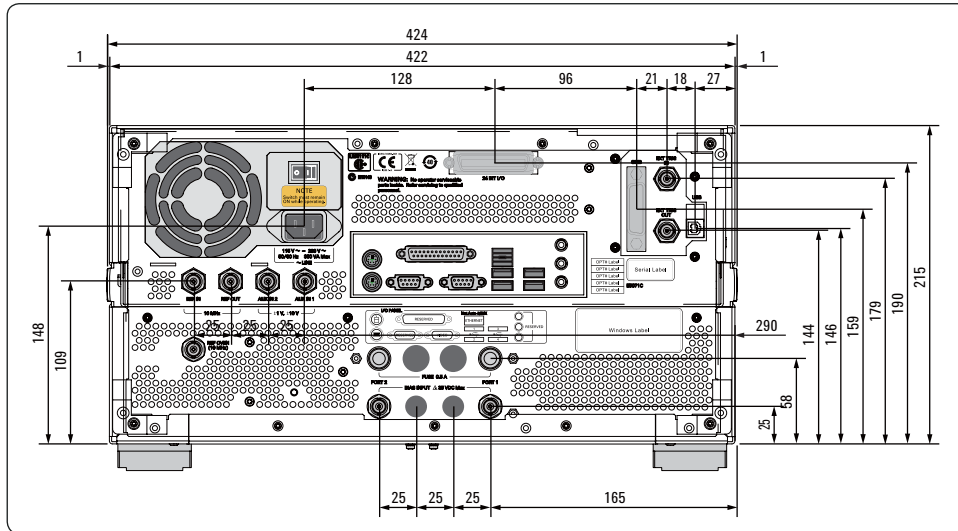

Figure 7. Dimensions (rear view with Option 1E5, in millimeters)

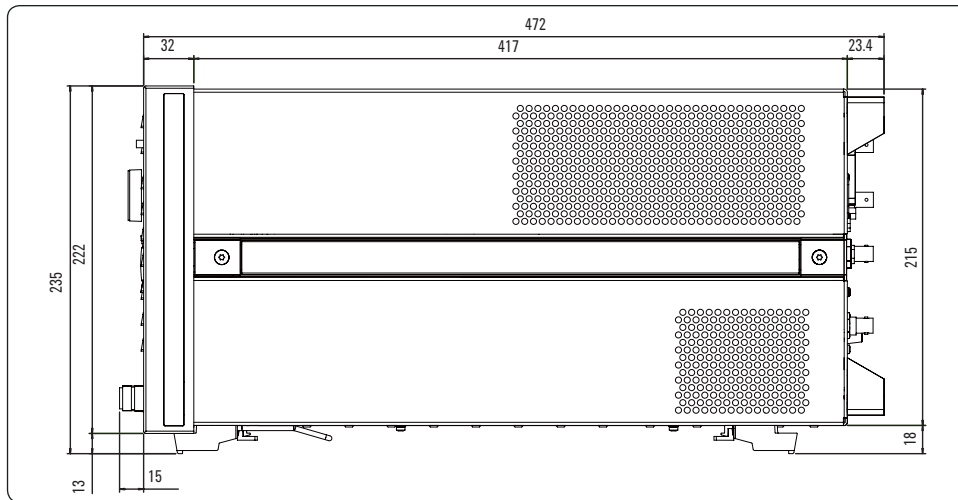

Figure 8. Dimensions (side view, E5071C Option 230/235/240/245/260/265/280/285/430/435/440/445/460/465/480/485, in millimeters)

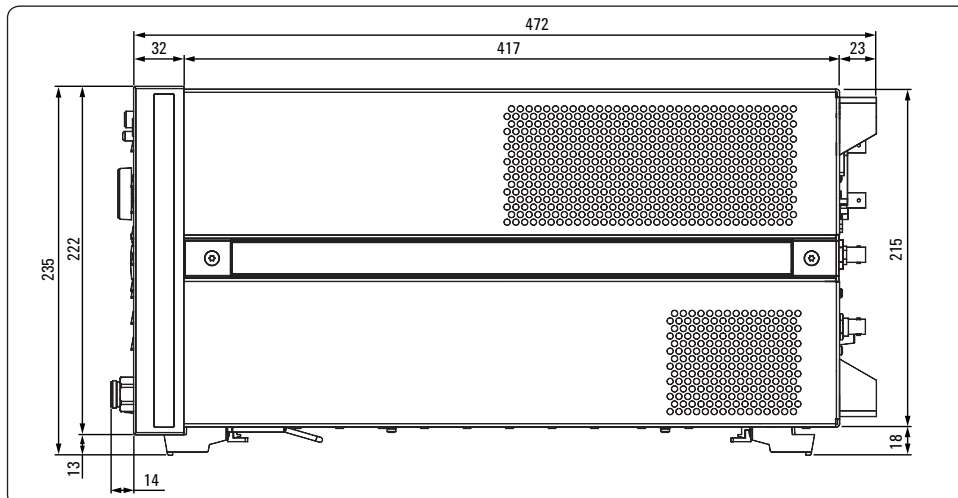

Figure 9. Dimensions (side view, E5071C with Option 2D5/2K5/4D5/4K5, in millimeters)

Measurement Throughput Summary

Cycle time for measurement completion^{1, 2} (ms)

Table 32. Option 230/235/240/245/260/265/280/285/430/435/440/445/460/465/480/485

Sweep mode: Swept, analyzer display turned off with: DISP:ENAB OFF, number of traces = 1, system error correction: OFF

	Number of points			
	51	201	401	1601
Start 1 GHz, stop 1.2 GHz, 500 kHz IF bandwidth				
Uncorrected	3.4	4.9	7.1	20
2-port cal	6.3	9.3	14	41
4-port cal	13	19	28	92
Start 1 GHz, stop 1.2 GHz, 100 kHz IF bandwidth				
Uncorrected	3.7	5.2	7.3	20
2-port cal	6.6	10	15	42
4-port cal	13	21	32	94
Start 1 GHz, stop 1.2 GHz, 1 kHz IF bandwidth				
Uncorrected	54	202	397	1563
2-port cal	107	401	792	3125
4-port cal	213	800	1581	6247
Start 100 kHz, stop 3 GHz, 500 kHz IF bandwidth				
Uncorrected	8.7	11	12	25
2-port cal	17	21	24	48
4-port cal	34	42	49	102
Start 100 kHz, stop 3 GHz, 100 kHz IF bandwidth				
Uncorrected	8.8	11	13	26
2-port cal	17	22	24	54
4-port cal	34	42	49	118
Start 100 kHz, stop 3 GHz, 1 kHz IF bandwidth				
Uncorrected	56	206	404	1583
2-port cal	112	410	805	3163
4-port cal	222	818	1608	6324

1. Supplemental performance data.

2. Measured with firmware version A.09.30.

Table 32. Option 230/235/240/245/260/265/280/285/430/435/440/445/
460/465/480/485 (continued)

	Number of points			
	51	201	401	1601
Start 100 kHz, stop 8.5 GHz, 500 kHz IF bandwidth				
Uncorrected	15	18	19	24
2-port cal	28	35	38	48
4-port cal	55	69	74	104
Start 100 kHz, stop 8.5 GHz, 100 kHz IF bandwidth				
Uncorrected	15	18	20	26
2-port cal	28	36	38	52
4-port cal	56	70	75	117
Start 100 kHz, stop 8.5 GHz, 1 kHz IF bandwidth				
Uncorrected	57	207	404	1583
2-port cal	114	412	806	3163
4-port cal	225	821	1611	6324

Cycle time for measurement completion^{1, 2} (ms)

Table 33. Option 230/235/240/245/260/265/280/285/430/435/440/445/460/465/480/485

Sweep mode: Swept, analyzer display turned off with: DISP:ENAB OFF, number of traces = 1, system error correction: ON

	Number of Points			
	51	201	401	1601
Start 1 GHz, stop 1.2 GHz, 500 kHz IF bandwidth				
Uncorrected	3.5	5.5	8.0	24
2-port cal	6.4	9.8	15	49
4-port cal	13	20	29	108
Start 1 GHz, stop 1.2 GHz, 100 kHz IF bandwidth				
Uncorrected	3.6	5.4	8.0	23
2-port cal	6.6	11	16	48
4-port cal	13	22	33	107
Start 1 GHz, stop 1.2 GHz, 1 kHz IF bandwidth				
Uncorrected	54	202	397	1563
2-port cal	107	401	792	3125
4-port cal	213	800	1581	6247
Start 100 kHz, stop 3 GHz, 500 kHz IF bandwidth				
Uncorrected	8.7	11	13	28
2-port cal	18	21	24	53
4-port cal	34	42	49	112
Start 100 kHz, stop 3 GHz, 100 kHz IF bandwidth				
Uncorrected	8.8	11	13	28
2-port cal	17	22	25	57
4-port cal	34	42	50	122
Start 100 kHz, stop 3 GHz, 1 kHz IF bandwidth				
Uncorrected	56	206	404	1583
2-port cal	112	410	805	3163
4-port cal	222	818	1608	6324

1. Supplemental performance data.

2. Measured with firmware version A.09.30.

Table 33. Option 230/235/240/245/260/265/280/285/430/435/440/445/
460/465/480/485 (continued)

	Number of points			
	51	201	401	1601
Start 100 kHz, stop 8.5 GHz, 500 kHz IF bandwidth				
Uncorrected	15	18	20	27
2-port cal	28	35	38	52
4-port cal	55	69	74	111
Start 100 kHz, stop 8.5 GHz, 100 kHz IF bandwidth				
Uncorrected	15	18	20	27
2-port cal	28	36	38	56
4-port cal	56	70	75	120
Start 100 kHz, stop 8.5 GHz, 1 kHz IF bandwidth				
Uncorrected	57	207	404	1583
2-port cal	114	412	806	3163
4-port cal	225	821	1611	6324

Cycle time for measurement completion^{1, 2} (ms)

Table 34. Option 230/235/240/245/260/265/280/285/430/435/440/445/460/465/480/485

Sweep mode: Stepped, analyzer display turned off with: DISP:ENAB OFF,
number of traces = 1, system error correction: ON

	Number of Points			
	51	201	401	1601
Start 1 GHz, stop 1.2 GHz, 500 kHz IF bandwidth				
Uncorrected	4.4	7.7	12	29
2-port cal	8.2	15	22	56
4-port cal	16	29	45	126
Start 1 GHz, stop 1.2 GHz, 100 kHz IF bandwidth				
Uncorrected	4.8	9.2	15	41
2-port cal	9.0	18	28	80
4-port cal	18	35	56	163
Start 1 GHz, stop 1.2 GHz, 1 kHz IF bandwidth				
Uncorrected	54	202	397	1563
2-port cal	107	401	792	3125
4-port cal	213	800	1581	6247
Start 100 kHz, stop 3 GHz, 500 kHz IF bandwidth				
Uncorrected	6.7	13	18	48
2-port cal	13	24	36	94
4-port cal	26	47	70	190
Start 100 kHz, stop 3 GHz, 100 kHz IF bandwidth				
Uncorrected	7.1	14	22	60
2-port cal	14	27	42	119
4-port cal	27	53	82	237
Start 100 kHz, stop 3 GHz, 1 kHz IF bandwidth				
Uncorrected	56	206	404	1583
2-port cal	112	410	805	3163
4-port cal	222	818	1608	6324

1. Supplemental performance data.

2. Measured with firmware version A.09.30.

Table 34. Option 230/235/240/245/260/265/280/285/430/435/440/445/
460/465/480/485 (continued)

	Number of points			
	51	201	401	1601
Start 100 kHz, stop 8.5 GHz, 500 kHz IF bandwidth				
Uncorrected	7.5	13	19	48
2-port cal	15	26	37	94
4-port cal	29	50	73	189
Start 100 kHz, stop 8.5 GHz, 100 kHz IF bandwidth				
Uncorrected	7.9	15	22	60
2-port cal	16	29	43	120
4-port cal	30	56	85	237
Start 100 kHz, stop 8.5 GHz, 1 kHz IF bandwidth				
Uncorrected	57	207	404	1583
2-port cal	114	412	806	3163
4-port cal	225	821	1611	6324

Cycle time for measurement completion^{1, 2} (ms)

Table 35. Option 2D5/2K5/4D5/4K5

Sweep mode: Swept, analyzer display turned off with: DISP:ENAB OFF,
number of traces = 1, system error correction: OFF

	Number of points			
	51	201	401	1601
Start 300 kHz, stop 20 GHz, 500 kHz IF bandwidth				
Uncorrected	23	36	39	43
2-port cal	45	71	77	85
4-port cal	88	142	155	169
Start 300 kHz, stop 20 GHz, 100 kHz IF bandwidth				
Uncorrected	23	37	40	43
2-port cal	45	72	78	86
4-port cal	89	144	156	171
Start 300 kHz, stop 20 GHz, 1 kHz IF bandwidth				
Uncorrected	60	212	410	1591
2-port cal	120	421	817	3180
4-port cal	237	840	1632	6358
Start 8 GHz, stop 18 GHz, 500 kHz IF bandwidth				
Uncorrected	17	22	22	23
2-port cal	34	42	44	45
4-port cal	67	83	86	102
Start 8 GHz, stop 18 GHz, 100 kHz IF bandwidth				
Uncorrected	18	22	23	24
2-port cal	34	42	44	47
4-port cal	67	84	87	106
Start 8 GHz, stop 18 GHz, 1 kHz IF bandwidth				
Uncorrected	58	207	405	1583
2-port cal	115	413	807	3163
4-port cal	229	823	1612	6324

1. Supplemental performance data.

2. Measured with firmware version A.09.30.

Table 35. Option 2D5/2K5/4D5/4K5 (continued)

	Number of points			
	51	201	401	1601
Start 11 GHz, stop 12 GHz, 500 kHz IF bandwidth				
Uncorrected	3.0	3.2	4.9	17
2-port cal	5.6	6.1	9.9	37
4-port cal	11	14	23	84
Start 11 GHz, stop 12 GHz, 100 kHz IF bandwidth				
Uncorrected	3.0	3.4	5.5	18
2-port cal	5.6	6.4	11	38
4-port cal	11	14	24	85
Start 11 GHz, stop 12 GHz, 1 kHz IF bandwidth				
Uncorrected	52	200	396	1566
2-port cal	104	399	790	3130
4-port cal	206	795	1578	6258

Cycle time for measurement completion^{1,2} (ms)

Table 36. Option 2D5/2K5/4D5/4K5

Sweep mode: Swept, analyzer display turned off with: DISP:ENAB OFF,
number of traces = 1, system error correction: ON

	Number of points			
	51	201	401	1601
Start 300 kHz, stop 20 GHz, 500 kHz IF bandwidth				
Uncorrected	23	36	39	43
2-port cal	45	71	77	85
4-port cal	88	142	155	170
Start 300 kHz, stop 20 GHz, 100 kHz IF bandwidth				
Uncorrected	23	37	40	43
2-port cal	45	72	78	86
4-port cal	89	144	156	171
Start 300 kHz, stop 20 GHz, 1 kHz IF bandwidth				
Uncorrected	60	212	410	1591
2-port cal	120	421	817	3180
4-port cal	237	840	1632	6358
Start 8 GHz, stop 18 GHz, 500 kHz IF bandwidth				
Uncorrected	17	22	22	23
2-port cal	34	42	44	48
4-port cal	67	83	86	107
Start 8 GHz, stop 18 GHz, 100 kHz IF bandwidth				
Uncorrected	18	22	23	24
2-port cal	34	42	44	49
4-port cal	67	83	87	110
Start 8 GHz, stop 18 GHz, 1 kHz IF bandwidth				
Uncorrected	58	207	405	1583
2-port cal	115	413	807	3163
4-port cal	229	823	1612	6324

1. Supplemental performance data.

2. Measured with firmware version A.09.30.

Table 36. Option 2D5/2K5/4D5/4K5 (continued)

	Number of points			
	51	201	401	1601
Start 11 GHz, stop 12 GHz, 500 kHz IF bandwidth				
Uncorrected	3.0	3.4	5.9	20
2-port cal	5.6	6.6	12	43
4-port cal	11	14	26	98
Start 11 GHz, stop 12 GHz, 100 kHz IF bandwidth				
Uncorrected	3.0	3.5	5.8	20
2-port cal	5.6	6.8	12	43
4-port cal	11	15	26	98
Start 11 GHz, stop 12 GHz, 1 kHz IF bandwidth				
Uncorrected	52	200	396	1566
2-port cal	104	399	790	3130
4-port cal	206	795	1578	6258

Cycle time for measurement completion^{1, 2} (ms)

Table 37. Option 2D5/2K5/4D5/4K5

Sweep mode: Stepped, analyzer display turned off with: DISP:ENAB OFF,
number of traces = 1, system error correction: ON

	Number of points			
	51	201	401	1601
Start 300 kHz, stop 20 GHz, 500 kHz IF bandwidth				
Uncorrected	11	18	24	56
2-port cal	21	35	48	112
4-port cal	41	69	94	222
Start 300 kHz, stop 20 GHz, 100 kHz IF bandwidth				
Uncorrected	11	20	28	69
2-port cal	22	38	54	137
4-port cal	42	75	107	272
Start 300 kHz, stop 20 GHz, 1 kHz IF bandwidth				
Uncorrected	60	212	410	1591
2-port cal	120	421	817	3180
4-port cal	237	840	1632	6358
Start 8 GHz, stop 18 GHz, 500 kHz IF bandwidth				
Uncorrected	8.4	14	19	48
2-port cal	17	27	38	94
4-port cal	32	52	74	188
Start 8 GHz, stop 18 GHz, 100 kHz IF bandwidth				
Uncorrected	8.8	15	22	60
2-port cal	17	30	44	120
4-port cal	34	58	86	237
Start 8 GHz, stop 18 GHz, 1 kHz IF bandwidth				
Uncorrected	58	207	405	1583
2-port cal	115	413	807	3163
4-port cal	229	823	1612	6324

1. Supplemental performance data.

2. Measured with firmware version A.09.30.

Table 37. Option 2D5/2K5/4D5/4K5 (continued)

	Number of points			
	51	201	401	1601
Start 11 GHz, stop 12 GHz, 500 kHz IF bandwidth				
Uncorrected	2.8	6.4	11	31
2-port cal	5.1	13	21	61
4-port cal	9.6	24	41	131
Start 11 GHz, stop 12 GHz, 100 kHz IF bandwidth				
Uncorrected	3.4	8.0	14	43
2-port cal	5.9	16	27	86
4-port cal	12	30	53	171
Start 11 GHz, stop 12 GHz, 1 kHz IF bandwidth				
Uncorrected	52	200	396	1566
2-port cal	104	399	790	3130
4-port cal	206	795	1578	6258

Cycle time (ms)^{1, 2} vs. number of points

Table 38. Option 230/235/240/245/260/265/280/285/430/435/440/445/460/465/480/485

Start 1 GHz, stop 1.2 GHz, 500 kHz IF bandwidth, error correction: OFF,
display update: OFF, number of traces = 1

Number of points	Sweep mode: Fast swept, system error correction: OFF	Sweep mode: Fast swept, system error correction: ON	Sweep mode: Std stepped, system error correction: ON
3	3.1	3.1	3.4
11	3.3	3.3	3.3
51	3.5	3.5	4.4
101	3.9	4.1	5.6
201	4.9	5.5	7.7
401	7.1	8.0	12
801	12	14	18
1601	20	24	29

Cycle time (ms)^{1, 2} vs. number of points

Table 39. Option 2D5/2K5/4D5/4K5

Start 11 GHz, stop 12 GHz, 500 kHz IF bandwidth, error correction: OFF,
display update: OFF, number of traces = 1

Number of points	Sweep mode: Fast swept, system error correction: OFF	Sweep mode: Fast swept, system error correction: ON	Sweep mode: Std stepped, system error correction: ON
51	3.0	3.0	2.8
201	3.2	3.4	6.5
401	4.9	5.9	11
1601	17	20	31

1. Supplemental performance data.
2. Measured with firmware version A.09.30.

Cycle time (ms)^{1, 2} vs. IF bandwidth

Table 40. All options

Sweep mode: Swept, analyzer display turned off with: DISP:ENAB OFF,
number of traces = 1, system error correction: OFF, NOP = 201

Option 230/235/240/245/260/265/280/ 285/430/435/440/445/460/465/480/485			Option 2D5/2K5/4D5/4K5		
Frequency [Hz]	IFBW [Hz]	Cycle time [ms]	Frequency [Hz]	IFBW [Hz]	Cycle time [ms]
4 G	500000	5.0	10 G	500000	2.8
4 G	400000	5.0	10 G	400000	2.8
4 G	300000	4.9	10 G	300000	2.8
4 G	200000	4.9	10 G	200000	2.8
4 G	150000	4.9	10 G	150000	2.8
4 G	100000	5.0	10 G	100000	3.0
4 G	70000	5.7	10 G	70000	3.8
4 G	50000	6.9	10 G	50000	4.9
4 G	40000	7.8	10 G	40000	5.9
4 G	30000	9.4	10 G	30000	7.5
4 G	20000	13	10 G	20000	11
4 G	15000	16	10 G	15000	14
4 G	10000	23	10 G	10000	21
4 G	7000	31	10 G	7000	29
4 G	5000	42	10 G	5000	40
4 G	4000	52	10 G	4000	50
4 G	3000	68	10 G	3000	66
4 G	2000	100	10 G	2000	98
4 G	1500	133	10 G	1500	132
4 G	1000	198	10 G	1000	196
4 G	700	278	10 G	700	276
4 G	500	391	10 G	500	389
4 G	400	487	10 G	400	485
4 G	300	648	10 G	300	646
4 G	200	970	10 G	200	968
4 G	150	1291	10 G	150	1289
4 G	100	1935	10 G	100	1933
4 G	70	2739	10 G	70	2739
4 G	50	3864	10 G	50	3869
4 G	40	4829	10 G	40	4837
4 G	30	6437	10 G	30	6449
4 G	20	9653	10 G	20	9671
4 G	15	12870	10 G	15	12892
4 G	10	19302	10 G	10	19330

1. Supplemental performance data.

2. Measured with firmware version A.09.30.

Data transfer time^{1, 2} (ms)

Table 41. All options

	Number of points			
	51	201	401	1601
SCPI over GPIB³				
64-bit floating point	4	12	25	88
32-bit floating point	3	7	13	45
ASCII	30	108	223	841
SCPI over 100 Mbps LAN (Telnet)³				
REAL 64	1	1	2	4
REAL 32	1	1	1	2
ASCII	15	59	117	457
SCPI over 100 Mbps LAN (SICL-LAN)³				
REAL 64	3	3	4	6
REAL 32	3	3	3	5
ASCII	4	8	14	47
SCPI over USB (SICL-USB)³				
REAL 64	2	2	2	3
REAL 32	2	2	2	3
ASCII	4	13	24	91
SCPI over GPIB/USB (82357B)				
REAL 64	8	15	21	68
REAL 32	7	10	13	37
ASCII	75	290	579	2313
COM⁴				
Variant type	1	1	1	1

1. Supplemental performance data.

2. Measured with firmware version A.09.30.

3. Measured using a VEE Pro 7.0 program running on a 3.2 GHz Pentium 4 DELL Precision 370, Transferred complex S_{11} data, using :CALC{1-36}:DATA:FDAT?.

4. Measured using an E5071C VBA macro running inside the analyzer. Transferred complex S_{11} data.

E5091A Multiport Test Set

The section provides port performance of test set without calibration.

Table 42. Test set input/output performance

Description	Specification	Typical
Range	50 MHz to 8.5 GHz	
Damage level		20 dBm, ±25 VDC (typical)

Table 43. Option E5091A-009 port performance

Description	Specification				
	50 MHz to 300 MHz	300 MHz to 1.3 GHz	1.3 GHz to 3 GHz	3 GHz to 6 GHz	6 GHz to 8.5 GHz
Load match					
Test port selected					
A, T2, R1+, R1–	19 dB	20 dB	18 dB	12 dB	10 dB
T1, R2+, R2–, R3+, R3–	15 dB	17 dB	15 dB	11 dB	8 dB
Test port unselected					
A, T2, R1+, R1–, R3+, R3–	23 dB	25 dB	19 dB	12 dB	11 dB
T1, R2+, R2–	18 dB	20 dB	16 dB	12 dB	9 dB
Interconnect port, typical					
P1, P2, P3, P4	19 dB	19 dB	17 dB	13 dB	9 dB
Insertion loss					
Test port					
A, T2, R1+, R1–	3 dB	3 dB	4 dB	5 dB	6 dB
T1, R2+, R2–, R3+, R3–	5 dB	5 dB	7 dB	8 dB	9.5 dB
Stability, typical	0.005 dB/° C	0.005 dB/° C	0.005 dB/° C	0.01 dB/° C	0.015 dB/° C
Isolation					
Over arbitrarily test ports	–100 dB	–100 dB	–100 dB	–100 dB	–90 dB

Table 44. Option E5091A-016 port performance

Description	Specification				
	50 MHz to 300 MHz	300 MHz to 1.3 GHz	1.3 GHz to 3 GHz	3 GHz to 6 GHz	6 GHz to 8.5 GHz
Load match					
Test port selected					
A, T4, R1+, R1-, R2+, R2-, R3+, R3-, R4+, R4-	15 dB	17 dB	15 dB	9 dB	8 dB
Test port unselected					
A, T4, T2, R1+, R1-, R2+, R2-, R3+, R3-, R4+, R4-, R4-	18 dB	20 dB	16 dB	10 dB	9 dB
T1, T2, T3	13 dB	15 dB	14 dB	8 dB	6 dB
Interconnect port, typical					
P1, P2, P3, P4	12 dB	12 dB	12 dB	9 dB	7 dB
Insertion loss					
Test port					
A, T4, R1+, R1-, R2+, R2-, R3+, R3-, R4+, R4-	6 dB	6 dB	7 dB	8 dB	9.5 dB
T1, T2, T3	6 dB	9 dB	10.5 dB	12 dB	14.5 dB
Stability per switch, typical	0.005 dB/° C	0.005 dB/° C	0.005 dB/° C	0.01 dB/° C	0.015 dB/° C
Isolation					
Over arbitrarily test ports	-100 dB	-100 dB	-100 dB	-100 dB	-80 dB

Table 45. Front panel information

Description	General characteristics
RF connectors	
Interconnect ports	Type-N, female, 50 Ω, nominal Number of ports 4 ports
Test ports (Option E5091A-009)	Type-N, female, 50 Ω, nominal Number of ports 9 ports
Test ports (Option E5091A-016)	SMA, female, 50 Ω, nominal Number of ports 25 ports (includes configurable switch port)
Control line	15 pin D-sub, female

Table 46. Rear panel information

Description	General characteristics
USB port	Type B-receptacle, provide connection to the E5071C
Line power ¹	
Frequency	47 to 63 Hz
Voltage	90 to 132 VAC, or 198 to 264 VAC (automatically switched)
VA max	150 VA max.

1. A third-wire ground is required.

Table 47. Test set dimensions and block diagram

Description	General characteristics
Dimensions	
Option E5091A-009	See Figure 10, 12, and 13
Option E5091A-016	See Figure 11, 12, and 15
Weight	
Option E5091A-009	6 kg
Option E5091A-016	7 kg
Block diagram	
Option E5091A-009/016	See Figure 15

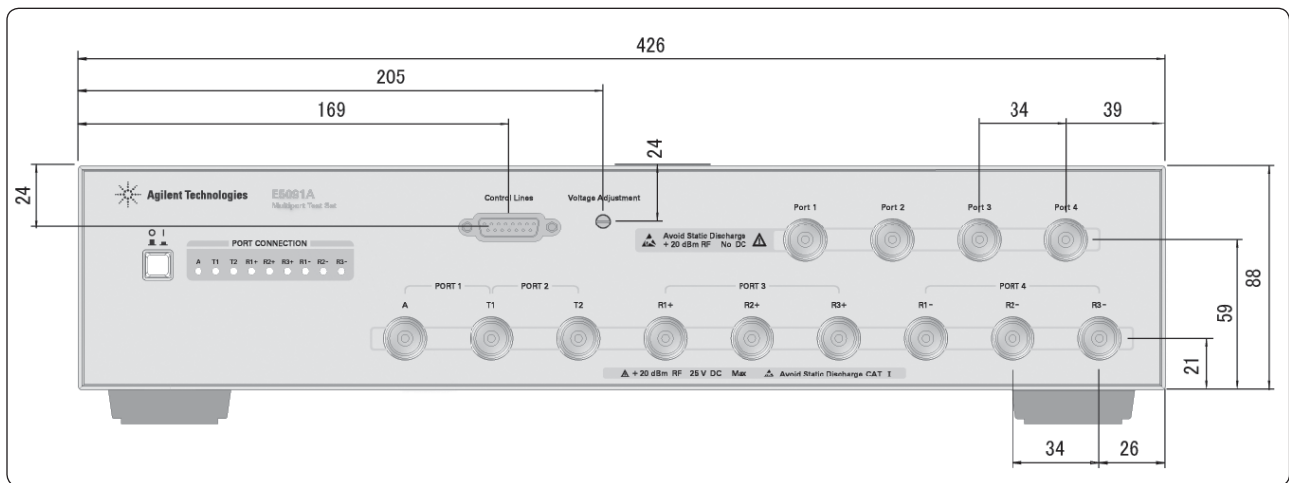

Figure 10. Dimensions (front view, with Option E5091A-009, in millimeters, nominal)

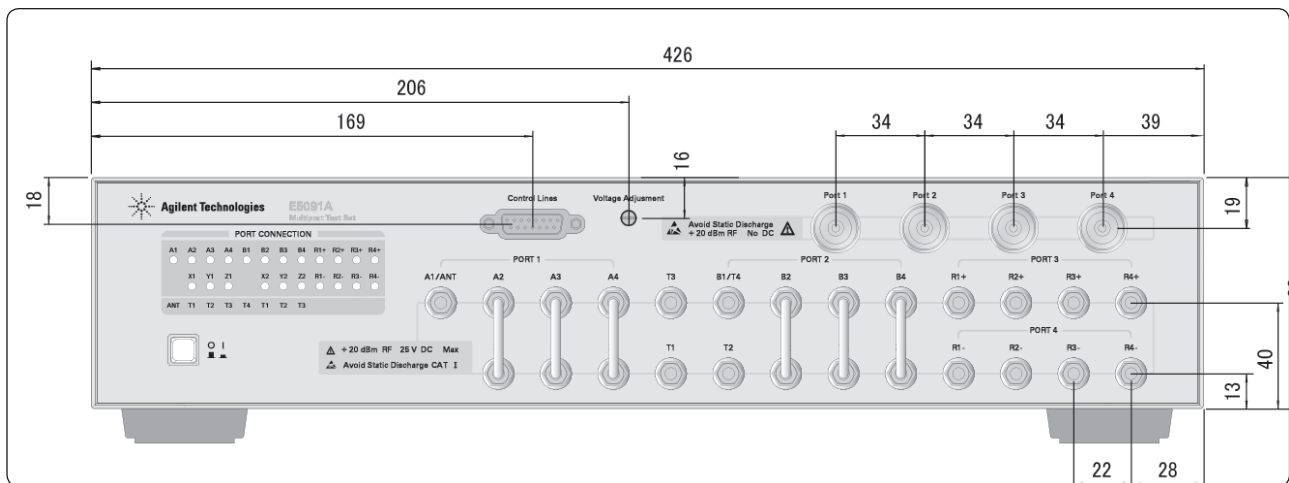

Figure 11. Dimensions (front view, with Option E5091A-016, in millimeters, nominal)

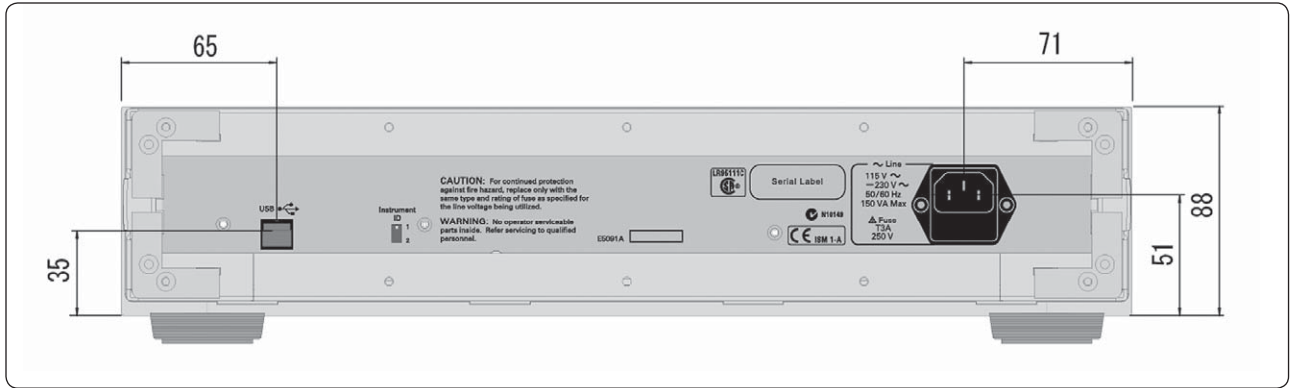

Figure 12. Dimensions (rear view, in millimeters, nominal)

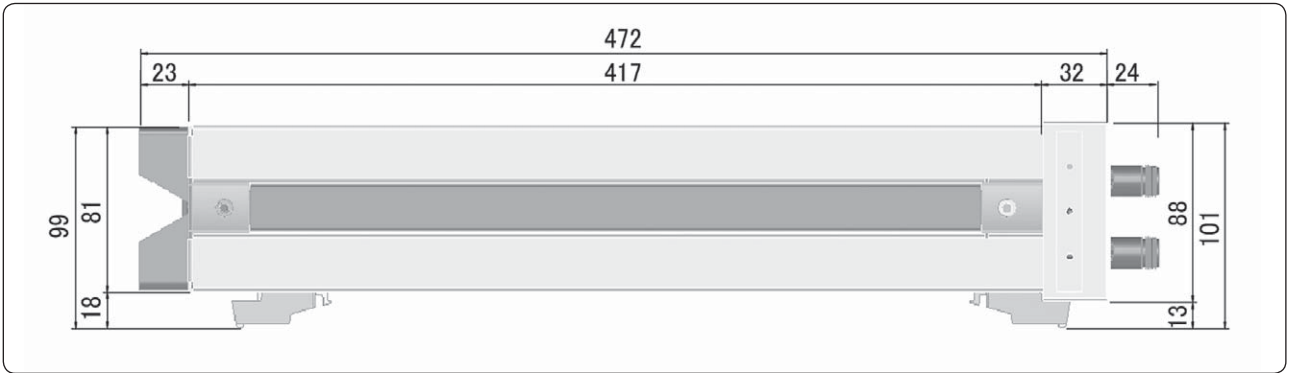

Figure 13 Dimensions (side view, with Option E5091A-009, in millimeters, nominal)

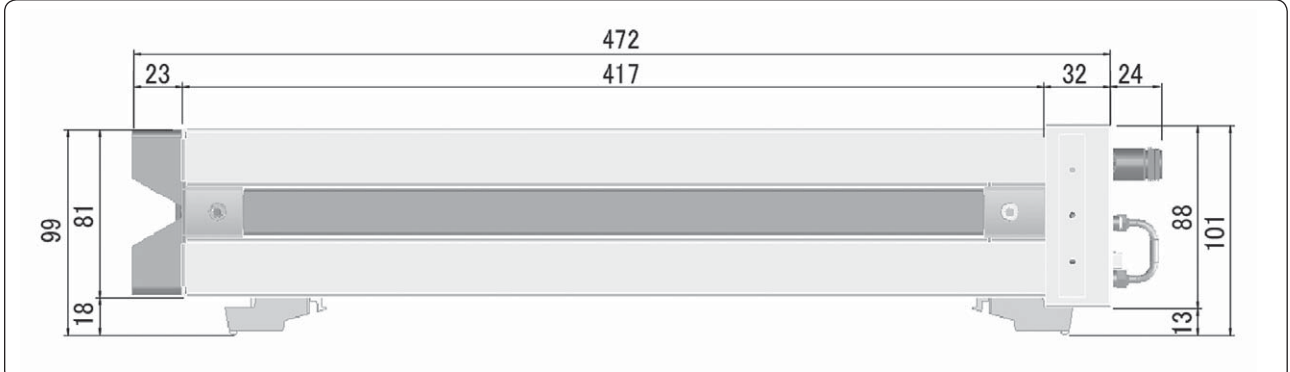

Figure 14. Dimensions (side view, with Option E5091A-016, in millimeters, nominal)

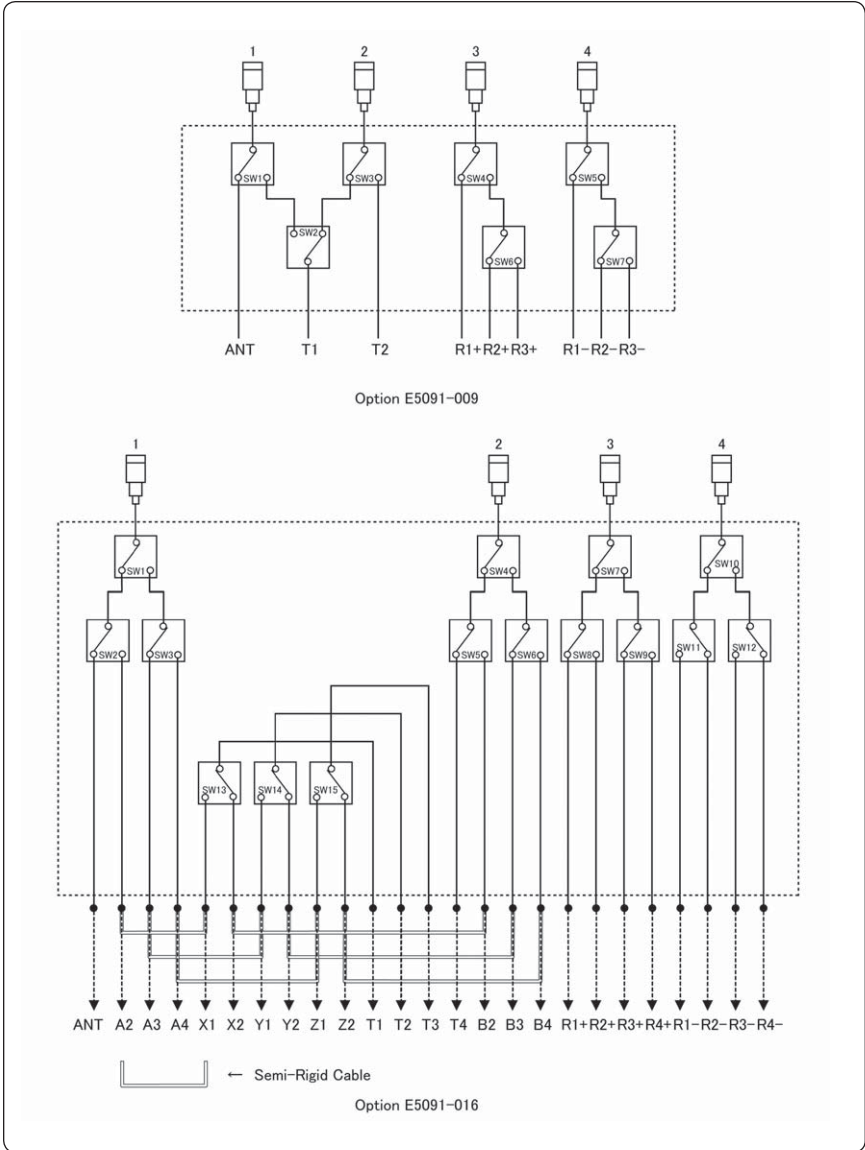

Figure 15. Block diagram

E5092A Configurable multiport test set

The section provides test input/output performance without calibration by the E5071C.

Table 48. Test set input/output performance

Description	Specification	Typical
Frequency range	50 MHz to 20 GHz	
Damage level		20 dBm, ± 35 VDC

Table 49. Option E5092A-020 port performance

Description	Specification	Typical
Load match (selected port)		
SPDT switch¹		
50 MHz to 2 GHz	17 dB	
2 GHz to 4 GHz	11 dB	
4 GHz to 8 GHz	8 dB	
8 GHz to 10 GHz	7 dB	
10 GHz to 18 GHz	4 dB	
18 GHz to 20 GHz	4 dB	
SP4T switch²		
50 MHz to 2 GHz	17 dB	
2 GHz to 3 GHz	11 dB	
3 GHz to 8 GHz	8 dB	
8 GHz to 10 GHz	7 dB	
10 GHz to 18 GHz	4 dB	
18 GHz to 20 GHz	4 dB	
Load match (unselected port)		
SPDT switch¹		
50 MHz to 3 GHz	17 dB	
3 GHz to 10 GHz	11 dB	
10 GHz to 16 GHz	8 dB	
16 GHz to 18 GHz	6 dB	
18 GHz to 20 GHz	4 dB	
SP4T switch²		
50 MHz to 3 GHz	17 dB	
3 GHz to 10 GHz	11 dB	
10 GHz to 16 GHz	8 dB	
16 GHz to 18 GHz	6 dB	
18 GHz to 20 GHz	4 dB	

1. SPDT: Single-pole-double-throw switches. Applies to SW5, SW6, SW7, SW8, SW9 and SW10 in the E5092A. (See Figure 20.)

2. SP4T: Single-pole-four-throw switches. Applies to SW1, SW2, SW3 and SW4 in the E5092A. (See Figure 20.)

Table 49. Option E5092A-020 port performance (continued)

Description	Specification	Typical
Load match (common port)		
SPDT switch¹		
50 MHz to 2 GHz	16 dB	
2 GHz to 4 GHz	11 dB	
4 GHz to 8 GHz	8 dB	
8 GHz to 10 GHz	7 dB	
10 GHz to 20 GHz	4 dB	
SP4T switch²		
50 MHz to 1.3 GHz	16 dB	
1.3 GHz to 4 GHz	11 dB	
4 GHz to 8 GHz	8 dB	
8 GHz to 10 GHz	7 dB	
10 GHz to 20 GHz	4 dB	
Insertion loss		
SPDT switch¹		
50 MHz to 100 MHz	4 dB	
100 MHz to 2 GHz	3.5 dB	
2 GHz to 3 GHz	4.5 dB	
3 GHz to 4 GHz	5 dB	
4 GHz to 6 GHz	5.5 dB	
6 GHz to 8 GHz	7 dB	
8 GHz to 10 GHz	8 dB	
10 GHz to 14 GHz	8.5 dB	
14 GHz to 18 GHz	10 dB	
18 GHz to 20 GHz	11.5 dB	
SP4T switch²		
50 to 100 MHz	4 dB	
100 MHz to 2 GHz	3.5 dB	
2 GHz to 3 GHz	4.5 dB	
3 GHz to 4 GHz	5.5 dB	
4 GHz to 6 GHz	6 dB	
6 GHz to 8 GHz	7.5 dB	
8 GHz to 10 GHz	8.5 dB	
10 GHz to 14 GHz	9.5 dB	
14 GHz to 18 GHz	10.5 dB	
18 GHz to 20 GHz	12 dB	
Stability		
50 MHz to 6 GHz		0.003 dB/°C
6 GHz to 20 GHz		0.01 dB/°C
		(Stability per switch)
Isolation³		
50 MHz to 500 MHz	65 dB	
500 MHz to 1 GHz	80 dB	
1 GHz to 2 GHz	85 dB	
2 GHz to 6 GHz	90 dB	
6 GHz to 10 GHz	85 dB	
10 GHz to 18 GHz	75 dB	
18 GHz to 20 GHz	65 dB	
	(Over arbitrarily test ports)	

1. SPDT: Single-pole-double-throw switches. Applies to SW5, SW6, SW7, SW8, SW9 and SW10 in the E5092A. (See Figure 20.)

2. SP4T: Single-pole-four-throw switches. Applies to SW1, SW2, SW3 and SW4 in the E5092A. (See Figure 20.)

3. This specification is defined when all ports are terminated with a 50 ohm load.

Table 50. Control line

Description	Specification	Typical
Number of groups	4 Group A: 8 bits Group B,C,D: 4 bits	
Input voltage range ¹	0 V to +5 V (positive input) –5 V to 0 V (negative input)	
Maximum current	Group A, B: 50 mA in total of each group Group C, D: 500 uA in total of each group	
Impedance		Group A, B: < 10 ohm Group C, D: < 200 ohm

Table 51. DC source

Description	Specification	Typical
Number of sources	4	
Output voltage range		0 V to +5.2 V (nominal) ²
Output voltage accuracy	±3 % of setting (+1 V to +5 V) at 1 M ohm load impedance	
Voltage resolution		10 mV (nominal) ³
Maximum current	150 mA for each source	
Output impedance		< 5 ohm

Table 52. Operating storage environment

Description	General characteristics
Temperature	+5 °C to +40 °C
Humidity	20 to 80% at wet bulb temperature < +29 °C (non-condensing)
Altitude	0 to 2,000m (0 to 6,561 feet)
Vibration	0.21 G max., 5 to 500 Hz

Table 53. Non-operating storage environment

Description	General characteristics
Temperature	–10 °C to +60 °C
Humidity	20 to 90 % at wet bulb temperature < +40 °C (non-condensing)
Altitude	0 to 4,572 m (0 to 15,000 feet)
Vibration	0.5 G max., 5 Hz to 500 Hz

1. Input voltage will be clipped at about ±5.2 V when over this range.
2. The output voltage can be set in this range.
3. The output voltage resolution becomes effective between 0 V to 5.2 V.

Table 54. Front panel information

Description	General characteristics
RF connectors	SMA
Test ports	38 ports
Control line	15-pin D-sub, female 25-pin D-sub, female

Table 55. Rear panel information

Description	General characteristics
USB port	Type B-receptacle, provide connection to the E5071C
Line power ¹	
Frequency	47 to 63 Hz
Voltage	90 to 132 VAC, or 198 to 264 VAC
VA max	(automatically switched) 300 VA max.

Table 56. Test set dimensions and block diagram

Description	General characteristics
Dimensions E5092A Option 020	See Figures 16, 17, 18 and 19
Weight E5092A Option 020	9 kg

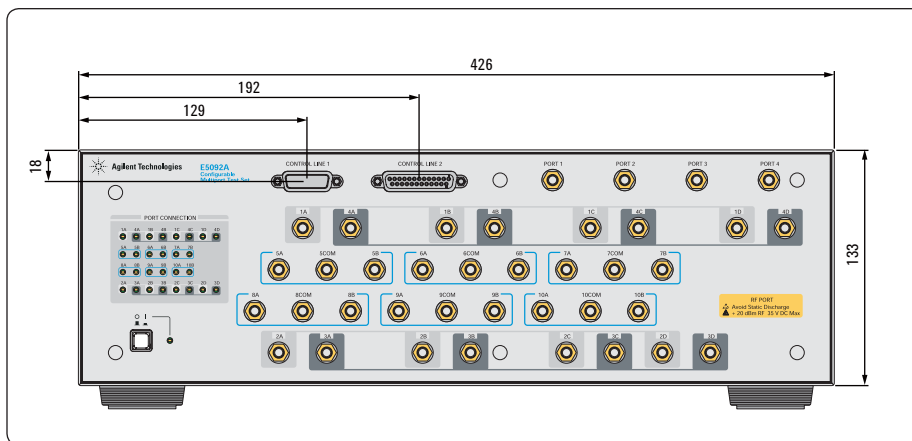

Figure 16. Dimensions (front view, with Option E5092A-020, in millimeters, nominal)

1. 1A third-wire ground is required.

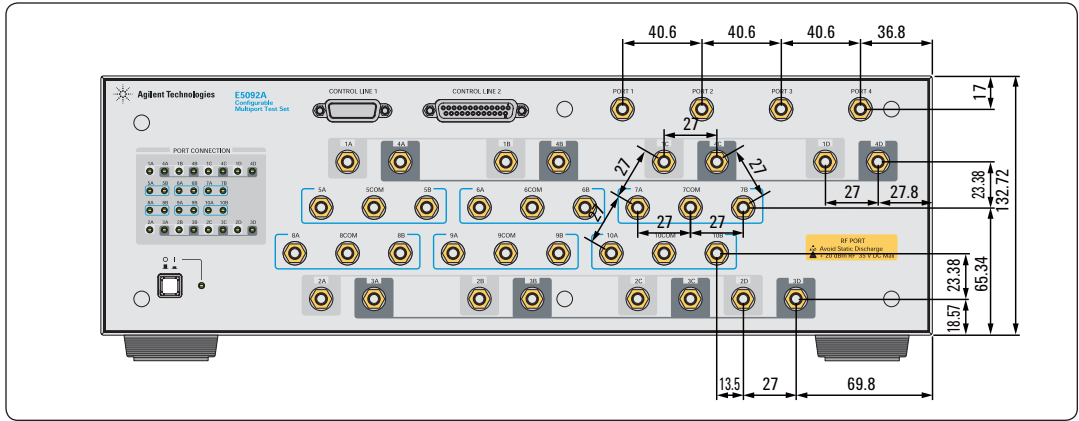

Figure 17. Dimensions (pitch between switches, with Option E5092A-020, in millimeters, nominal)

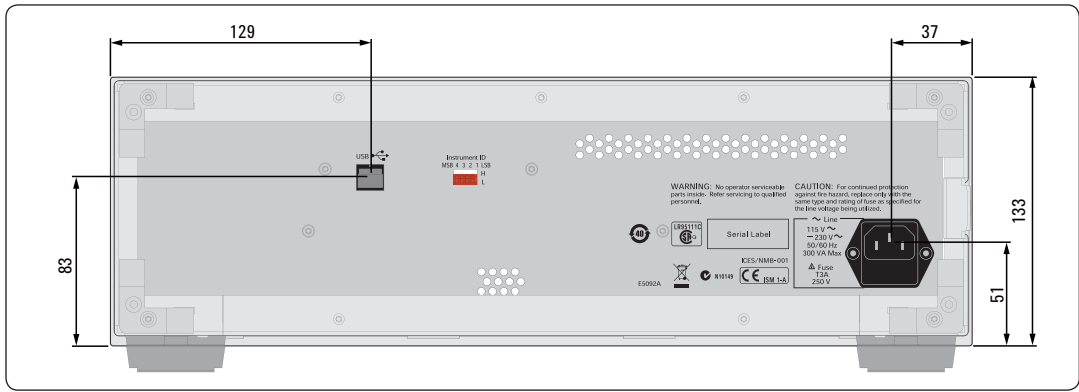

Figure 18. Dimensions (rear view, with Option E5092A-020, in millimeters, nominal)

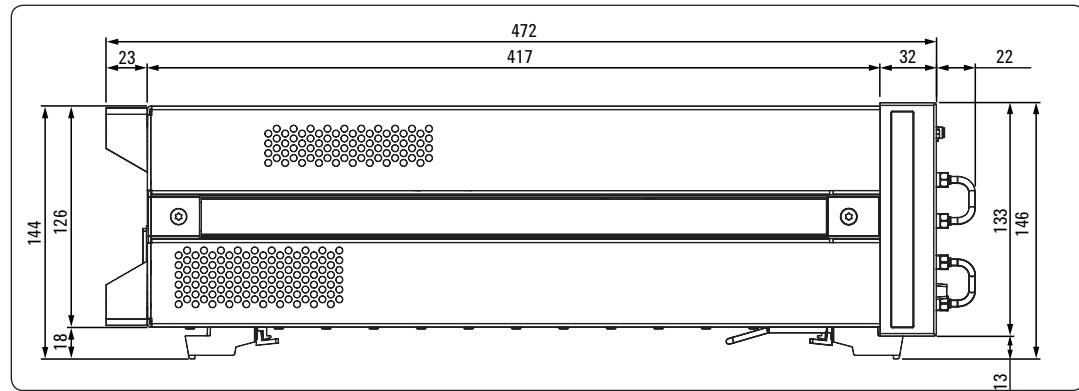

Figure 19. Dimensions (side view, with Option E5092A-020, in millimeters, nominal)

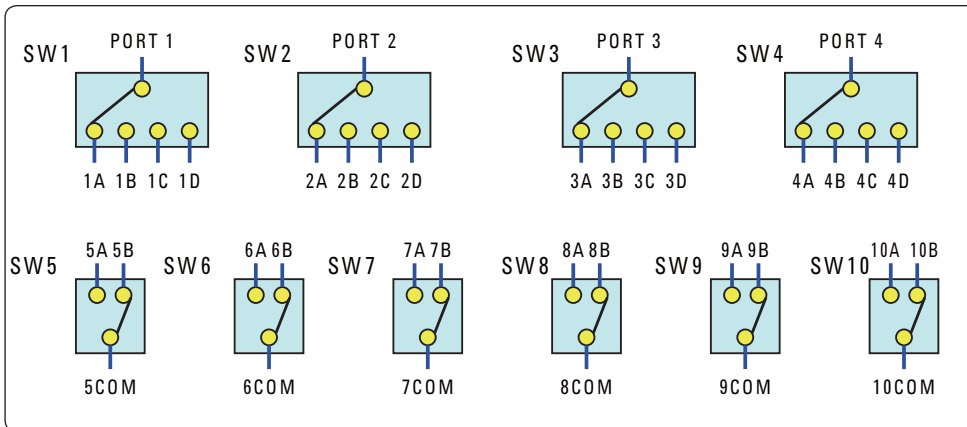

Figure 20. Switch configuration (E5092A-020)

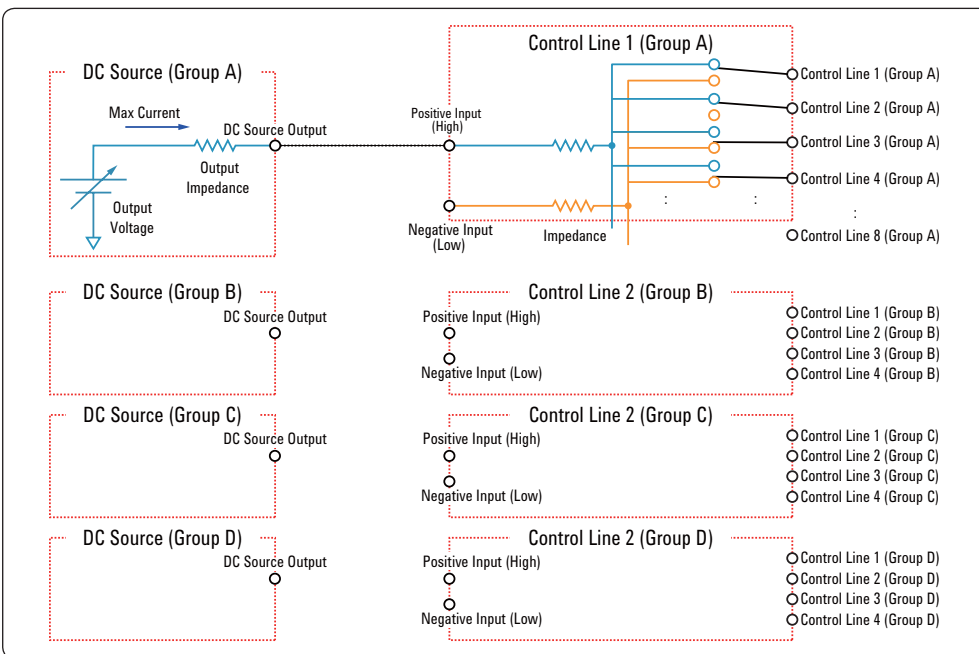

Figure 21. DC control line (E5092A-020)

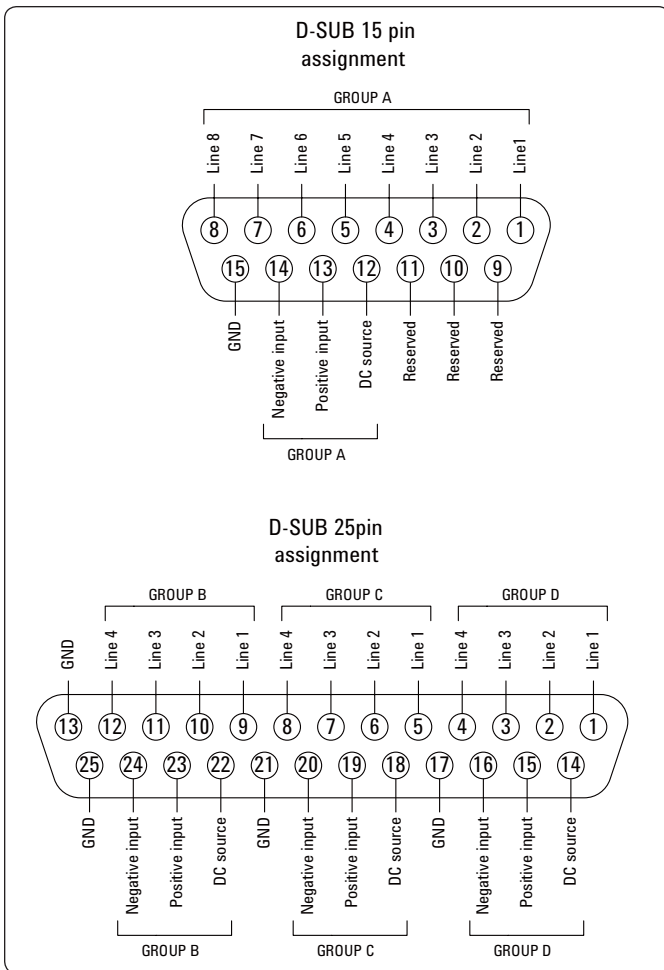

Figure 22. Control line pin assignment (E5092A-020)

Corrected System Performance for 75 Ω Measurements with 11852B 50 to 75 Ω Minimum-Loss Pads (Supplemental Information)

Option 230/235/240/245/260/265/280/285/430/435/440/445/
460/465/480/485

Table 55. Corrected system performance with type-N 75 Ω device connectors, 85036E calibration kit

Network analyzer: E5071C
calibration kit: 85036E (type-N 75 Ω)
50 to 75 Ω adapters: 11852B
calibration: full 2-port

IF bandwidth = 10 Hz, no averaging applied to data, environmental temperature = 23° C
±5° C with < 1° C deviation from calibration temperature, isolation calibration performed

Description	Typical (dB)
	10 MHz to 3 GHz
Directivity	37
Source match	33
Load match	39
Reflection tracking	±0.015
Transmission tracking	±0.019

Transmission uncertainty 10 MHz to 3 GHz (typical)

Magnitude

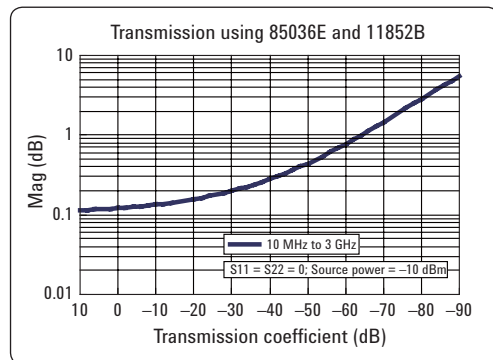

Phase

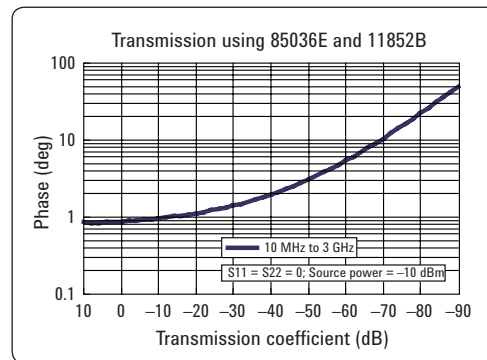

Reflection uncertainty 10 MHz to 3 GHz (typical)

Magnitude

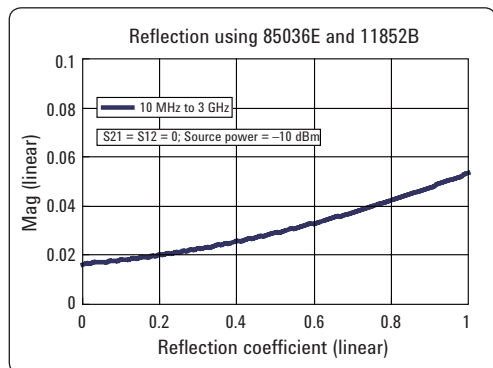

Phase

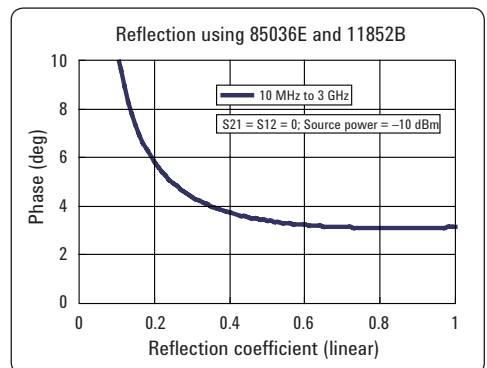



Agilent Email Updates

www.agilent.com/find/emailupdates
Get the latest information on the products and applications you select.



Agilent Direct

www.agilent.com/find/agilentdirect
Quickly choose and use your test equipment solutions with confidence.



www.lxistandard.org

LXI is the LAN-based successor to GPIB, providing faster, more efficient connectivity. Agilent is a founding member of the LXI consortium.

Remove all doubt

Our repair and calibration services will get your equipment back to you, performing like new, when promised. You will get full value out of your Agilent equipment throughout its lifetime. Your equipment will be serviced by Agilent-trained technicians using the latest factory calibration procedures, automated repair diagnostics and genuine parts. You will always have the utmost confidence in your measurements. For information regarding self maintenance of this product, please contact your Agilent office.

Agilent offers a wide range of additional expert test and measurement services for your equipment, including initial start-up assistance, onsite education and training, as well as design, system integration, and project management.

For more information on repair and calibration services, go to:

www.agilent.com/find/removealldoubt

www.agilent.com
www.agilent.com/find/ena

For more information on Agilent Technologies' products, applications or services, please contact your local Agilent office. The complete list is available at:

www.agilent.com/find/contactus

Americas

Canada	(877) 894-4414
Latin America	305 269 7500
United States	(800) 829-4444

Asia Pacific

Australia	1 800 629 485
China	800 810 0189
Hong Kong	800 938 693
India	1 800 112 929
Japan	0120 (421) 345
Korea	080 769 0800
Malaysia	1 800 888 848
Singapore	1 800 375 8100
Taiwan	0800 047 866
Thailand	1 800 226 008

Europe & Middle East

Austria	01 36027 71571
Belgium	32 (0) 2 404 93 40
Denmark	45 70 13 15 15
Finland	358 (0) 10 855 2100
France	0825 010 700*
Germany	07031 464 6333
Ireland	1890 924 204
Israel	972-3-9288-504/544
Italy	39 02 92 60 8484
Netherlands	31 (0) 20 547 2111
Spain	34 (91) 631 3300
Sweden	0200-88 22 55
Switzerland	0800 80 53 53
United Kingdom	44 (0) 118 9276201

Other European Countries:

www.agilent.com/find/contactus

Revised: March 24, 2009

Product specifications and descriptions in this document subject to change without notice.

© Agilent Technologies, Inc. 2007-2009
Printed in USA, July 30, 2009
5989-5479EN



Agilent Technologies