

# Agilent Technologies Measurement Modules for the 16900 Series

## Data Sheet

Modularity is the key to the Agilent 16900 Series logic analysis systems' long term value. You purchase only the capability you need now, then expand as your needs evolve. All modules are tightly integrated to provide time-correlated, cross domain measurements.

Customize your system with the measurement capability that will meet your performance and price needs. Protect your investment by upgrading logic analyzer module memory depths or state speeds as your needs change.

### Measurement Capability:

- Timing/State logic analyzers
- Pattern Generator
- Time Correlation to external scopes

### Timing/State Logic Analyzer Modules

Agilent's timing and state modules give you the power to:

- Accurately measure precise timing relationships using 4 GHz (250 ps) timing zoom with 64 K depth.
- Extend the measurement window with precision when signals transition less frequently using transitional timing.
- Find anomalies separated in time with deep memory depths (up to 256 M across all channels).
- Buy what you need today and upgrade in the future. 16900 Series timing/state modules come with independent upgrades for memory depth and state speed.
- Sample high-speed synchronous buses accurately and confidently using eye finder. Eye finder automatically adjusts threshold and setup and hold for your highest confidence in measurements on high-speed buses.

- Track problems from symptom to root cause across several measurement modes by viewing time-correlated data in waveform/chart, listing, inverse assembly, source code, or compare display.
- Set up triggers quickly and confidently with intuitive simple, quick, and advanced triggering. This capability combines new trigger functionality with an intuitive user interface.
- The Agilent logic analyzer modules are compatible with the industry's widest range of probing accessories with capacitive loading down to 0.7 pF.
- Monitor and correlate multiple buses using a single module with split analyzer capability. This provides single and multi-bus support using a single module (timing, state, timing/state or state/state configurations).



# Logic Analyzer Selection Guide for 16900 Series Mainframes



Agilent Model Number	16910A/16911A	16950B/16951B	16760A
Channels per module	102/68	68	34
Maximum channels on single time base	510/340	340	170
<b>Timing Mode</b>			
High-speed timing zoom [1]	4 GHz (250 ps) with 64 K depth	4 GHz (250 ps) with 64 K depth	N/A
Maximum timing sample rate: half channel mode	1.0 GHz (1 ns)	1.2 GHz (833 ps)	800 MHz
Maximum timing sample rate: full channel mode	500 MHz (2.0 ns)	600 MHz (1.67 ns)	800 MHz
Transitional timing	500 MHz (2.0 ns)	600 MHz (1.67 ns)	400 MHz
<b>State Mode</b>			
Maximum state clock rate	450 MHz with option 500, 250 MHz with option 250	667 MHz	800 Mb/s (full channel), 1.5 Gb/s (half channel)
Maximum state data rate	500 Mb/s with option 500, 250 Mb/s with option 250	667 Mb/s (DDR) 1066 Mb/s (Dual Sample)	1.5 Gb/s
Setup/hold window Adjustment resolution	1.5 ns 80 ps typical	1 ns (600 ps typical), 80 ps typical	1 ns 10 ps
State clock, data rate (upgradeable)	Yes (Agilent E5865A for 16910A) (Agilent E5866A for 16911A)	No	No
Automated threshold/sample position, Simultaneous eye diagrams, all channels	Yes	Yes	Yes
<b>Memory Depth [2]</b>			
256 M		16951B	
64 M		16950B, Option 064	16760A
32 M	Option 032	16950B, Option 032	
16 M	Option 016	16950B, Option 016	
4 M	Option 004	16950B, Option 004	
1 M	Option 001	16950B, Option 001	
256 K	Option 256		
Memory depth (upgradeable)	Yes (Agilent E5865A for 16910A) (Agilent E5866A for 16911A)	Yes (Agilent E5875A)	64 M standard
<b>Other</b>			
Supported signal types	Single-ended	Single-ended and differential	Single-ended and differential
Probe compatibility [3]	40-pin cable connector	90-pin cable connector	90-pin cable connector
Voltage threshold	-5 V to 5 V (10 mV increments)	-3 V to 5 V (10 mV increments)	-3 V to 5 V (10 mV increments)
Threshold Accuracy	±50 mV + 1% of setting	±30 mV ±2% of setting	±(30 mV + 1% of setting)

[1] All channels, all the time, simultaneous state and timing through same probe.

[2] Specify desired memory depth using available options.

[3] Probes are ordered separately. Please specify probes when ordering to ensure the correct connection between your logic analyzer and the device under test.

# Data Acquisition and Stimulus

## Timing/State Modules

Agilent logic analyzer modules offer the speed, features, and usability your digital development team needs to quickly debug, validate, and optimize your digital system – at a price that fits your budget.

### Accurately measure precise timing relationships

Make accurate high-speed timing measurements with 4 GHz (250 ps) high-speed timing zoom. A parallel acquisition architecture provides high-speed timing measurements simultaneously through the same probe with other state or timing measurements. Timing zoom stays active all the time with no tradeoffs. View data at high resolution over longer periods of time with 64 K deep timing zoom.

### Automate measurement setup and quickly gain diagnostic clues

Quickly get up and running by automating your measurement setup process. In addition, the logic analyzer's setup/hold window (or sampling position) and threshold voltage settings are automatically determined so that data on high-speed buses is

captured with the highest accuracy. Auto Threshold and Sample Position mode allows you to...

- Obtain accurate and reliable measurements
- Save time during measurement setup
- Gain diagnostic clues and identify problem signals quickly
- Scan all signals and buses simultaneously or just a few
- View results as a composite display or as individual signals
- See skew between signals and buses
- Find and fix inappropriate clock thresholds
- Measure data valid windows
- Identify signal integrity problems related to rise times, fall times, data valid window widths

### Identify problem signals over hundreds of channels simultaneously

As timing and voltage margins continue to shrink, confidence in signal integrity becomes an increasingly vital requirement in the design validation process. Eye scan lets you acquire signal integrity information on all the buses in your design, under a wide variety of operating conditions, in a matter of minutes. Identify problem signals quickly for further investigation with an oscilloscope. Results can be viewed for each individual signal or as a composite of multiple signals or buses.

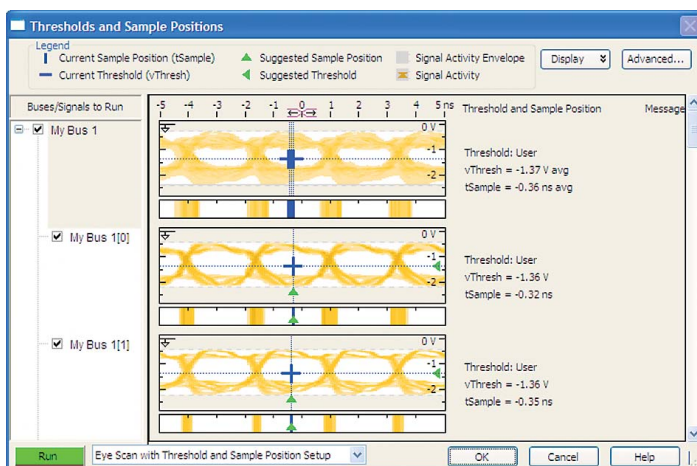

Figure 1. Identify problem signals quickly by viewing eye diagrams across all buses and signals simultaneously.

# Data Acquisition and Stimulus Pattern Generation Modules

## Digital Stimulus and Response in a Single Instrument

Configure the logic analysis system to provide both stimulus and response in a single instrument. For example, the pattern generator can simulate a circuit initialization sequence and then signal the state or timing analyzer to begin measurements. Use the compare mode on the state analyzer to determine if the circuit or subsystem is functioning as expected. Time correlate to an external oscilloscope to help locate the source of timing problems or troubleshoot signal problems due to noise, ringing, overshoot, crosstalk, or simultaneous switching.

## Parallel Testing of Subsystems Reduces Time to Market

By testing system subcomponents before they are complete, you can fix problems earlier in the development process. Use the Agilent 16720A as a substitute for missing boards, integrated circuits (ICs), or buses instead of waiting for the missing pieces. Software engineers can create infrequently encountered test conditions and verify that their code works—before complete hardware is available. Hardware engineers can generate the patterns necessary to put their circuit in the desired state, operate the circuit at full speed or step the circuit through a series of states.

## Key Characteristics

### Agilent Model 16720A

Maximum clock (full/half channel)	180/300 MHz
Number of data channels (full/half channel)	48/24 Channels
Memory depth (full/half channels)	8/16 MVectors
Maximum vector width (5 module system, full/half channel)	240/120 Bits
Logic levels supported	5V TTL, 3-state TTL, 3-state TTL/CMOS, 3-state 1.8V, 3-state 2.5V, 3-state 3.3V, ECL, 5V PECL, 3.3V LVPECL, LVDS
Editable vector size (full/half channels)	8/16 MVectors

# Data Acquisition and Stimulus Pattern Generation Modules

## Vectors Up To 240 Bits Wide

Vectors are defined as a “row” of labeled data values, with each data value from one to 32 bits wide. Each vector is output on the rising edge of the clock.

Up to five, 48-channel 16720A modules can be interconnected within a 16900 Series mainframe. This configuration supports vectors of any width up to 240 bits with excellent channel-to-channel skew characteristics (see specific data pod characteristics in Pattern Generation Modules Specifications starting on page 23). The modules operate as one time-base with one master clock pod. Multiple modules also can be configured to operate independently with individual clocks controlling each module.

## Depth Up to 16 MVectors

With the 16720A pattern generator, you can load and run up to 16 MVectors of stimulus. Depth on this scale is most useful when coupled with powerful stimulus generated by electronic design automation tools, such as SynaptiCAD’s WaveFormer and VeriLogger. These tools create stimulus using a combination of graphically drawn signals, timing parameters that constrain edges, clock signals, and temporal and Boolean equations for describing complex signal behavior. The stimulus also can be created from design simulation waveforms. The SynaptiCAD tools allow you to convert .VCD files into .PGB files directly, offering you an integrated solution that saves you time.

## Synchronized Clock Output

You can output data synchronized to either an internal or external clock. The external clock is input via a clock pod, and has no minimum frequency (other than a 2 ns minimum high time).

The internal clock is selectable between 1 MHz and 300 MHz in 1 MHz steps. A Clock Out signal is available from the clock pod and can be used as an edge strobe with a variable delay of up to 8 ns.

## Initialize (INIT) Block for Repetitive Runs

When running repetitively, the vectors in the initialize (init) sequence are output only once, while the main sequence is output as a continually repeating sequence. This “init” sequence is very useful when the circuit or subsystem needs to be initialized. The repetitive run capability is especially helpful when operating the stimulus module independent of the other modules in the logic analysis system.

## “Send Arm out to...” Coordinates System Module Activity

A “Send Arm out to...” instruction acts as a trigger arming event for other logic analysis modules to begin measurements. Arm setup and trigger setup of the other logic analysis modules determine the action initiated by “Send Arm out to...”.

## “Wait for External Event” for Input Pattern

The clock pod also accepts a 3-bit input pattern. These inputs are level-sensed so that any number of “Wait for External Event” instructions can be inserted into a stimulus program. Up to four pattern conditions can be defined from the OR-ing of the eight possible 3-bit input patterns. A “Wait for External Event” also can be defined to wait for an Arm. This Arm signal can come from any other module in the logic analysis system.

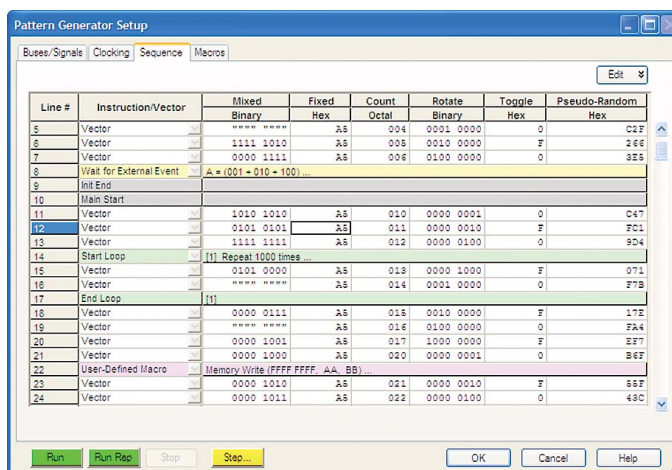

Figure 2. Define your unique stimulus vectors, including an initialization sequence, in the Sequence tab.

# Data Acquisition and Stimulus Pattern Generation Modules

## **“User-Defined Macro” and “Loop” Simplify Creation of Stimulus Programs**

User macros permit you to define a pattern sequence once, then insert the macro by name wherever it is needed. Passing parameters to the macro will allow you to create a more generic macro. For each call to the macro you can specify unique values for the parameters.

Loops enable you to repeat a defined block of vectors for a specified number of times. Loops and macros can be nested, except that a macro can not be nested within another macro. At compile time, loops and macros are expanded in memory to a linear sequence.

## **Convenient Data Entry and Editing Feature**

You can conveniently enter patterns in hex, octal, binary, decimal, and signed decimal (two's complement) bases. The data associated with an individual label can be viewed with multiple radices to simplify data entry. Delete, Insert, and Copy commands are provided for easy editing. Fast and convenient Pattern Fills give the programmer useful test patterns with a few key strokes. Fixed, Count, Rotate, Toggle, and Random are available to quickly create a test pattern, such as “walking ones.” Pattern parameters, such as Step Size and Repeat Frequency, can be specified in the pattern setup.

## **ASCII Input File Format: Your Design Tool Connection**

The 16720A supports an ASCII file format to facilitate connectivity to other tools in your design environment. Because the ASCII format does not support the instructions listed earlier, they cannot be edited into the ASCII file. User macros and loops also are not supported, so the vectors need to be fully expanded in the ASCII file. Many design tools will generate ASCII files and output the vectors in this linear sequence. Data must be in Hex format, and each label must represent a set of contiguous output channels.

## **Configuration**

The 16720A pattern generators require a single slot in a logic analysis system frame. The pattern generator operates with the clock pods, data pods, and lead sets described later in this section. At least one clock pod and one data pod must be selected to configure a functional system. Users can select from a variety of pods to provide the signal source needed for their logic devices. The data pods, clock pods and data cables use standard connectors. The electrical characteristics of the data cables also are described for users with specialized applications who want to avoid the use of a data pod. The 16720A can be configured in systems with up to five cards for a total of 240 channels of stimulus.

## **Direct Connection to Your Target System**

The pattern generator pods can be directly connected to a standard connector on your target system. Use a 3M brand #2520 Series, or similar connector. The 16720A clock or data pods will plug right in. Short, flat cable jumpers can be used if the clearance around the connector is limited. Use a 3M #3365/20, or equivalent, ribbon cable; a 3M #4620 Series, or equivalent, connector on the 16720A pod end of the cable; and a 3M #3421 Series, or equivalent, connector at your target system end of the cable.

## **Probing Accessories**

The probe tips of the Agilent 10474A, 10347A, 10498A, and E8142A lead sets plug directly into any 0.1 inch grid with 0.026 inch to 0.033 inch diameter round pins or 0.025 inch square pins. These probe tips work with the Agilent 5090-4356 surface mount grabbers and with the Agilent 5959-0288 through-hole grabbers.

# Agilent 16910A and 16911A Specifications and Characteristics

Module Channel Counts	State Analysis 16910A	State Analysis 16911A	Timing Analysis 16910A	Timing Analysis 16911A
1-card module	98 data + 4 clocks	64 data + 4 clocks	102	68
2-card module	200 data + 4 clocks	132 data + 4 clocks	204	136
3-card module	302 data + 4 clocks	200 data + 4 clocks	306	204
4-card module	404 data + 4 clocks	268 data + 4 clocks	408	272
5-card module	506 data + 4 clocks	336 data + 4 clocks	510	340

## Probes

A probe must be used to connect the logic analyzer to your target system. Probes are ordered separately from the logic analysis module. For specifications and characteristics of a particular probe, see the documentation that is supplied with your probe or search for the probe's model number in this help system or at [www.agilent.com](http://www.agilent.com) or *Probing Solutions for Agilent Technologies Logic Analyzers* Product Overview, publication number 5968-4632E.

## Timing Zoom

Timing analysis sample rate	4 GHz
Time interval accuracy	
Within a pod pair	$\pm (1.0 \text{ ns} + 0.01\% \text{ of time interval reading})$
Between pod pairs	$\pm (1.75 \text{ ns} + 0.01\% \text{ of time interval reading})$
Memory depth	64 K samples
Trigger position	Start, center, end, or user-defined
Minimum data pulse width	1 ns

# Agilent 16910A and 16911A Specifications and Characteristics

State (Synchronous) Analysis Mode	Option 250	Option 500
tWidth* [1]	1.5 ns	1.5 ns
tSetup	0.5 tWidth	0.5 tWidth
tHold	0.5 tWidth	0.5 tWidth
tSample range [2]	-3.2 ns to +3.2 ns	-3.2 ns to +3.2 ns
tSample adjustment resolution	80 ps typical	80 ps typical
Maximum state data rate on each channel	250 Mb/s	500 Mb/s
Maximum channels on a single time base and trigger [4]	16910A: 510 – (number of clocks) 16911A: 340 – (number of clocks)	16910A: 510 – (number of clocks) 16911A: 340 – (number of clocks)
Memory depth [4] (Option 256 is included in base price)	Option 256: 256 K samples Option 001: 1 M samples Option 004: 4 M samples Option 016: 16 M samples Option 032: 32 M samples	Option 256: 256 K samples Option 001: 1 M samples Option 004: 4 M samples Option 016: 16 M samples Option 032: 32 M samples
Number of independent analyzers [5]	2	1
Number of clocks [6]	4	1
Number of clock qualifiers [6]	4	N/A
Minimum time between active clock edges* [7]	4.0 ns	2.0 ns
Minimum master to slave clock time	1 ns	N/A
Minimum slave to master clock time	1 ns	N/A
Minimum slave to slave clock time	4.0 ns	N/A

\* Items marked with an asterisk (\*) are specifications. All others are characteristics.

"Typical" represents the average or median value of the parameter based on measurements from a significant number of units.

[1] Minimum eye width in system under test.

[2] Sample positions are independently adjustable for each data channel input. A negative sample position causes the input to be synchronously sampled by that amount before each active clock edge. A positive sample position causes the input to be synchronously sampled by that amount after each active clock edge. A sampling position of zero causes the input to be synchronously sampled coincident with each clock edge.

[3] Use of eye finder is recommended in 450 MHz and 500 Mb/s state mode.

[4] In 250 Mb/s state mode, with all pods assigned, memory depth is half the maximum memory depth. With one pod pair (34 channels) unassigned, the memory depth is full. One pod pair (34 channels) must remain unassigned for time tags in 500 Mb/s state mode.

[5] Independent analyzers may be either state or timing. When the 500 Mb/s state mode is selected, only one analyzer may be used.

[6] In the 250 Mb/s state mode, the total number of clocks and qualifiers is 4. All clock and qualifier inputs must be on the master modules.

[7] Tested with input signal  $V_h = +1.3$  V,  $V_l = +0.7$  V, threshold = +1.0 V,  $t_r/t_f = 180$  ps  $\pm$  30 ps (10%, 90%).

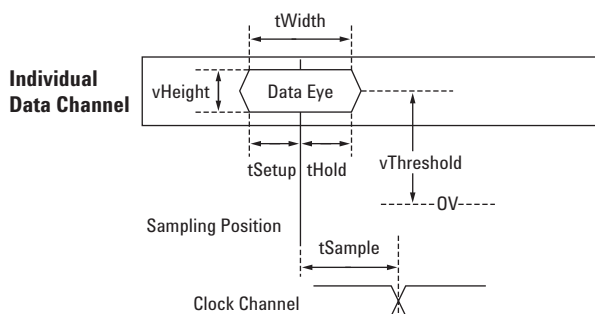



# Agilent 16910A and 16911A Specifications and Characteristics

State (Synchronous) Analysis Mode	Option 250	Option 500
Minimum state clock pulse width		
Single edge	1.0 ns	1.0 ns
Multiple edge	1.0 ns	2.0 ns
Clock qualifier setup time	500 ps	N/A
Clock qualifier hold time	0	N/A
Time tag resolution	2 ns	1.5 ns
Maximum time count between stored states	32 days	32 days
Maximum trigger sequence speed	250 MHz	500 MHz
Maximum trigger sequence levels	16	16
Trigger sequence level branching	Arbitrary 4-way if/then/else	2-way if/then/else
Trigger position	Start, center, end, or user-defined	Start, center, end, or user-defined
Trigger resources	16 patterns evaluated as =, =/, >, ≥, <, ≤ 14 double-bounded ranges evaluated as in range, not in range 2 timers per module 2 global counters 1 occurrence counter per sequence level 4 flags	14 patterns evaluated as =, =/, >, ≥, <, ≤ 7 double-bounded ranges evaluated as in range, not in range 1 occurrence counter per sequence level 4 flags
Trigger resource conditions	Arbitrary Boolean combinations	Arbitrary Boolean combinations
Trigger actions	Go To Trigger, send e-mail, and fill memory Trigger and Go To Store/don't store sample Turn on/off default storing Timer start/stop/pause/resume Global counter increment/decrement/reset Occurrence counter reset Flag set/clear	Go To Trigger and fill memory
Store qualification	Default (global) and per sequence level	Default (global)
Maximum global counter	2E+24	N/A
Maximum occurrence counter	2E+24	2E+24
Maximum pattern width	128 bits	128 bits
Maximum range width	64 bits	64 bits
Timers range	60 ns to 2199 seconds	N/A
Timer resolution	2 ns	N/A
Timer accuracy	± (5 ns +0.01%)	N/A
Timer reset latency	60 ns	N/A

# Agilent 16910A and 16911A Specifications and Characteristics

Timing (Asynchronous) Analysis Mode	Conventional Timing	Transitional Timing [8]
Sample rate on all channels	500 MHz	500 MHz
Sample rate in half channel mode	1000 MHz	N/A
Number of channels	16910A: 102 x (number of modules)  16911A: 68 x (number of modules)	16910A: For sample rates < 500 MHz: 102 x (number of modules) For 500 MHz sample rate: 102 x (number of modules) – 34 16911A: For sample rates < 500 MHz: 68 x (number of modules) For 500 MHz sample rate: 68 x (number of modules) – 34
Maximum channels on a single time base and trigger	16910A: 510 16911A: 340	16910A: 510 16911A: 340
Number of independent analyzers [5]	2	2
Sample period (half channel)	1.0 ns	N/A
Minimum sample period (full channel)	2.0 ns	2.0 ns
Minimum data pulse width	1 sample period + 1.0 ns	1 sample period + 1.0 ns
Time interval accuracy	$\pm (1 \text{ sample period} + 1.25 \text{ ns} + 0.01\% \text{ of time interval reading})$	$\pm (1 \text{ sample period} + 1.25 \text{ ns} + 0.01\% \text{ of time interval reading})$
Memory depth in full channel mode (Option 256 is included in base price)	Option 256: 256 K samples Option 001: 1 M samples Option 004: 4 M samples Option 016: 16 M samples Option 032: 32 M samples	Option 256: 256 K samples Option 001: 1 M samples Option 004: 4 M samples Option 016: 16 M samples Option 032: 32 M samples
Memory depth in half channel mode (Option 256 is included in base price)	Option 256: 512 K samples Option 001: 2 M samples Option 004: 8 M samples Option 016: 32 M samples Option 032: 64 M samples	N/A
Maximum trigger sequence speed	250 MHz	250 MHz
Maximum trigger sequence levels	16	16

[5] Independent analyzers may be either state or timing. When the 500 Mb/s state mode is selected, only one analyzer may be used.

[8] Transitional timing speed and memory depth are halved unless a spare pod pair (34 channels) is unassigned.

# Agilent 16910A and 16911A Specifications and Characteristics

Timing (Asynchronous) Analysis Mode	Conventional Timing	Transitional Timing
Trigger sequence level branching	Arbitrary 4-way if/then/else	Arbitrary 4-way if/then/else
Trigger position	Start, center, end, or user-defined	Start, center, end, or user-defined
Trigger resources	16 patterns evaluated as =, =/, >, ≥, <, ≤ 14 double-bounded ranges evaluated as in range, not in range 3 edge/glitch 2 timers per module 2 global counters 1 occurrence counter per sequence level 4 flags	15 patterns evaluated as =, =/, >, ≥, <, ≤ 14 double-bounded ranges evaluated as in range, not in range 3 edge/glitch 2 timers per module 2 global counters 1 occurrence counter per sequence level 4 flags
Trigger resource conditions	Arbitrary Boolean combinations	Arbitrary Boolean combinations
Trigger actions	Go To Trigger, send e-mail, and fill memory Trigger and Go To Turn on/off default storing Timer start/stop/pause/resume Global counter increment/decrement/reset Occurrence counter reset Flag set/clear	Go To Trigger, send e-mail, and fill memory Trigger and Go To Turn on/off default storing Timer start/stop/pause/resume Global counter increment/decrement/reset Occurrence counter reset Flag set/clear
Maximum global counter	2E+24	2E+24
Maximum occurrence counter	2E+24	2E+24
Maximum range width	32 bits	32 bits
Maximum pattern width	128 bits	128 bits
Timer value range	60 ns to 2199 seconds	60 ns to 2199 seconds
Timer resolution	2 ns	2 ns
Timer accuracy	± (5 ns +0.01%)	± (5 ns +0.01%)
Greater than duration	4.0 ns to 67 ms in 4.0 ns increments	4.0 ns to 67 ms in 4.0 ns increments
Less than duration	8.0 ns to 67 ms in 4.0 ns increments	8.0 ns to 67 ms in 4.0 ns increments
Timer reset latency	60 ns	60 ns

# Agilent 16950B and 16951B Specifications and Characteristics

## 16950 Series module overview

The 16950A, 16950B and 16951B are all compatible with the 16900 Series mainframes. This table

shows the key differences for the 16950 series modules. All other specifications and characteristics are the same.

16950 Series module connections:

- You can combine up to five 16951Bs in a multiple-card set. The combined set will have 256 M memory depth across all channels.
- You can combine up to five 16950Bs in a multiple-card set. The combined set will default to the lowest memory depth in the set.
- You can combine any combination of 16753A, 16754A, 16755A, 16756A, and 16950As in a multiple-card set. The combined set will default to the lowest memory depth in the set.

	16951B	16950B	16950A
State speed	667 MHz	667 MHz	600 MHz
Max data rate	667 Mb/s (DDR) 1066 Mb/s (Dual sample)	667 Mb/s (DDR) 1066 Mb/s (Dual sample)	600 Mb/s (DDR) 800 Mb/s (Dual sample)
Memory depth	256 M	1 M to 64 M	256 K to 64 M
Minimum eye width in system under test	550 ps typical	550 ps typical	600 ps typical
Minimum time between active clock edges	1.50 ns (667 Mb/s state mode)	1.50 ns (667 Mb/s state mode)	1.67 ns (600 Mb/s state mode)
Minimum state clock pulse width	1.50 ns	1.50 ns	1.67 ns

## Module Channel Counts

## State Analysis

## Timing Analysis

1-card module	64 data + 4 clocks	68
2-card module	132 data + 4 clocks	136
3-card module	200 data + 4 clocks	204
4-card module	268 data + 4 clocks	272
5-card module	336 data + 4 clocks	340

## Probes

A probe must be used to connect the logic analyzer to your target system. For specifications and characteristics of a particular probe, see the documentation that is supplied with your probe or search for the probe's model number in this help system or at [www.agilent.com](http://www.agilent.com).

## Timing Zoom

Timing analysis sample rate	4 GHz
Time interval accuracy	
Within a pod pair	± (1.0 ns + 0.01% of time interval reading)
Between pod pairs	± (1.75 ns + 0.01% of time interval reading)
Memory depth	64 K samples
Trigger position	Start, center, end, or user-defined
Minimum data pulse width	750 ps

# Agilent 16950B and 16951B Specifications and Characteristics

State (Synchronous) Analysis Mode	300 Mb/s State Mode	667 Mb/s State Mode
tWidth* [1, 2]	850 ps*, 550 ps typical	850 ps*, 550 ps typical
tSetup	0.5 tWidth	0.5 tWidth
tHold	0.5 tWidth	0.5 tWidth
tSample range [3]	-4 ns to +4 ns	-4 ns to +4 ns
tSample adjustment resolution	80 ps typical	80 ps typical
tSample accuracy, manual adjustment	± 300 ps	± 300 ps [4]
Maximum state data rate	300 Mb/s (DDR) 600 Mb/s (Dual sample)	667 Mb/s (DDR) 1066 Mb/s (Dual sample)
Maximum channels on a single time base and trigger [5]	340 – (number of clocks)	306 – (1 clock)
Memory depth – 16950B [5]	Option 001: 1 M samples Option 004: 4 M samples Option 016: 16 M samples Option 032: 32 M samples Option 064: 64 M samples	Option 001: 1 M samples Option 004: 4 M samples Option 016: 16 M samples Option 032: 32 M samples Option 064: 64 M samples
Memory depth – 16951B [5]	256 M samples	256 M samples
Number of independent analyzers [6]	2	1
Number of clocks [7]	4	1
Number of clock qualifiers [7]	4	N/A
Minimum time between active clock edges* [8]	3.33 ns	1.50 ns
Minimum master to slave clock time	1 ns	N/A
Minimum slave to master clock time	1 ns	N/A
Minimum slave to slave clock time	3.33 ns	N/A

\* Items marked with an asterisk (\*) are specifications. All others are characteristics.

[1] Minimum eye width in system under test.

[2] Your choice of probe can limit system bandwidth. Choose a probe rated at 1066 Mb/s or greater to maintain system bandwidth.

[3] Sample positions are independently adjustable for each data channel input. A negative sample position causes the input to be synchronously sampled by that amount before each active clock edge. A positive sample position causes the input to be synchronously sampled by that amount after each active clock edge. A sampling position of zero causes the input to be synchronously sampled coincident with each clock edge.

[4] Use of eye finder is recommended in 667 Mb/s state mode.

[5] In 300 Mb/s state mode, with all pods assigned, memory depth is half the maximum memory depth. With one pod pair (34 channels) unassigned, the memory depth is full. One pod pair (34 channels) must remain unassigned for time tags in 667 Mb/s state mode.

[6] Independent analyzers may be either state or timing. When the 667 Mb/s state mode is selected, only one analyzer may be used.

[7] In the 300 Mb/s state mode, the total number of clocks and qualifiers is 4. All clock and qualifier inputs must be on the master modules.

[8] Tested with input signal  $V_h = +1.125$  V,  $V_l = +0.875$  V = 1 V/ns, threshold = +1.0 V,  $t_r/t_f = 180$  ps ± 30 ps (10%, 90%).

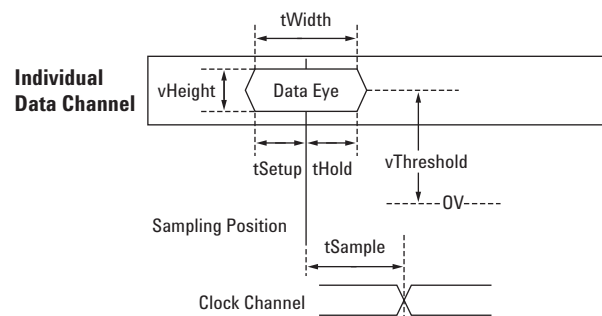

# Agilent 16950B and 16951B Specifications and Characteristics

State (Synchronous) Analysis Mode	300 Mb/s State Mode	667 Mb/s State Mode
Minimum state clock pulse width		
Single edge	1.0 ns	500 ps
Multiple edge	1.0 ns	1.50 ns
Clock qualifier setup time	500 ps	N/A
Clock qualifier hold time	0	N/A
Time tag resolution	2 ns	1.5 ns
Maximum time count between stored states	32 days	32 days
Maximum trigger sequence speed	300 MHz	667 MHz
Maximum trigger sequence levels	16	16
Trigger sequence level branching	Arbitrary 4-way if/then/else	2-way if/then/else
Trigger position	Start, center, end, or user-defined	Start, center, end, or user-defined
Trigger resources	16 patterns evaluated as =, =/, >, ≥, <, ≤ 14 double-bounded ranges evaluated as in range, not in range 2 timers per module 2 global counters 1 occurrence counter per sequence level 4 flags	14 patterns evaluated as =, =/, >, ≥, <, ≤ 7 double-bounded ranges evaluated as in range, not in range 1 occurrence counter per sequence level 4 flags
Trigger resource conditions	Arbitrary Boolean combinations	Arbitrary Boolean combinations
Trigger actions	Go To Trigger, send e-mail, and fill memory Trigger and Go To Store/don't store sample Turn on/off default storing Timer start/stop/pause/resume Global counter increment/decrement/reset Occurrence counter reset Flag set/clear	Go To Trigger and fill memory
Store qualification	Default (global) and per sequence level	Default (global)
Maximum global counter	2E+24	N/A
Maximum occurrence counter	2E+24	2E+24
Maximum pattern width	128 bits	128 bits
Maximum range width	64 bits	64 bits
Timers range	50 ns to 2199 seconds	N/A
Timer resolution	2 ns	N/A
Timer accuracy	± (5 ns +0.01%)	N/A
Timer reset latency	50 ns	N/A

# Agilent 16950B and 16951B Specifications and Characteristics

Timing (Asynchronous) Analysis Mode	Conventional Timing	Transitional Timing [9]
Sample rate on all channels	600 MHz	600 MHz
Sample rate in half channel mode	1200 MHz	N/A
Number of channels	68 x (number of modules)	For sample rates < 600 MHz: 68 x (number of modules). For 600 MHz sample rate: 68 x (number of modules) – 34
Maximum channels on a single time base and trigger	340	340
Number of independent analyzers [6]	2	2
Sample period (half channel)	833 ps	N/A
Minimum sample period (full channel)	1.67 ns	1.67 ns
Minimum data pulse width	1 sample period + 500 ps	1 sample period + 500 ps
Time interval accuracy	$\pm (1 \text{ sample period} + 1.25 \text{ ns} + 0.01\% \text{ of time interval reading})$	$\pm (1 \text{ sample period} + 1.25 \text{ ns} + 0.01\% \text{ of time interval reading})$
Memory depth in full channel mode – 16950B	Option 001: 1 M samples Option 004: 4 M samples Option 016: 16 M samples Option 032: 32 M samples Option 064: 64 M samples	Option 001: 1 M samples Option 004: 4 M samples Option 016: 16 M samples Option 032: 32 M samples Option 064: 64 M samples
Memory depth in full channel mode – 16951B	256 M samples	256 M samples
Memory depth in half channel mode – 16950B	Option 001: 2 M samples Option 004: 8 M samples Option 016: 32 M samples Option 032: 64 M samples Option 064: 128 M samples	N/A
Memory depth in half channel mode – 16951B	512 M samples	N/A
Maximum trigger sequence speed	300 MHz	300 MHz
Maximum trigger sequence levels	16	16

[6] Independent analyzers may be either state or timing. When the 600 Mb/s state mode is selected, only one analyzer may be used.

[9] Transitional timing speed and memory depth are halved unless a spare pod pair (34 channels) is unassigned.

# Agilent 16950B and 16951B Specifications and Characteristics

Timing (Asynchronous) Analysis Mode	Conventional Timing	Transitional Timing
Trigger sequence level branching	Arbitrary 4-way if/then/else	Arbitrary 4-way if/then/else
Trigger position	Start, center, end, or user-defined	Start, center, end, or user-defined
Trigger resources	16 patterns evaluated as =, =/, >, ≥, <, ≤ 14 double-bounded ranges evaluated as in range, not in range 3 edge/glitch 2 timers per module 2 global counters 1 occurrence counter per sequence level 4 flags	15 patterns evaluated as =, =/, >, ≥, <, ≤ 14 double-bounded ranges evaluated as in range, not in range 3 edge/glitch 2 timers per module 2 global counters 1 occurrence counter per sequence level 4 flags
Trigger resource conditions	Arbitrary Boolean combinations	Arbitrary Boolean combinations
Trigger actions	Go To Trigger, send e-mail, and fill memory Trigger and Go To Turn on/off default storing Timer start/stop/pause/resume Global counter increment/decrement/reset Occurrence counter reset Flag set/clear	Go To Trigger, send e-mail, and fill memory Trigger and Go To Turn on/off default storing Timer start/stop/pause/resume Global counter increment/decrement/reset Occurrence counter reset Flag set/clear
Maximum global counter	2E+24	2E+24
Maximum occurrence counter	2E+24	2E+24
Maximum pattern/range width	32 bits	32 bits
Maximum pattern width	128 bits	128 bits
Timer value range	50 ns to 2199 seconds	50 ns to 2199 seconds
Timer resolution	2 ns	2 ns
Timer accuracy	± (5 ns +0.01%)	± (5 ns +0.01%)
Greater than duration	3.33 ns to 55 ms in 3.3 ns increments	3.33 ns to 55 ms in 3.3 ns increments
Less than duration	6.67 ns to 55 ms in 3.3 ns increments	6.67 ns to 55 ms in 3.3 ns increments
Timer reset latency	50 ns	50 ns



# Agilent 16760A Specifications and Characteristics

## Agilent Technologies 16760A Supplemental Specifications\* and Characteristics

### Synchronous Data Sampling

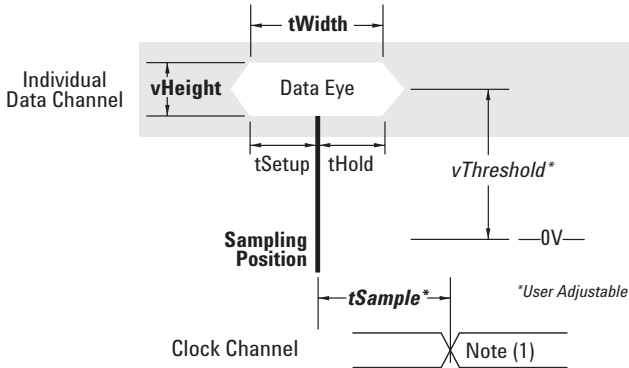

### Specifications for Each Input

Parameter		Minimum		Description/Notes
		800, 1250, 1500 Mb/s modes	200, 400 Mb/s modes	
Data to Clock	tWidth	500 ps	1.25 ns	Eye width in system under test [2]
	tSetup	250 ps	625 ps	Data setup time required before tSample
	tHold	250 ps	625 ps	Data hold time required after tSample
All Inputs	vHeight [1]	100mV	100mV	E5379A 100-pin differential probe [3] E5381A differential flying-lead probe [3] E5387A differential soft touch [3]
		250 mV	250 mV	E5405A differential pro series soft touch [3] E5378A 100-pin single-ended probe [4], E5382A single-ended flying-lead probe set E5406A pro series soft touch [4] E5390A soft touch [4]
		300mV	300mV	E5398A half-size soft touch [4] E5380A 38-pin single-ended probe

\* All specifications noted by an asterisk in the table are the performance standards against which the product is tested.

[1] The analyzer can be configured to sample on the rising edge, the falling edge, or both edges of the clock. If both edges are used with a single ended clock input, take care to set the clock threshold accurately to avoid phase error.

[2] Eye width and height are specified at the probe tip. Eye width as measured by eye finder in the analyzer may be less, and still sample reliably.

[3] For each side of a differential signal.

[4] The clock inputs in the E5378A, E5398A, E5406A, E5390A, and E5382A may be connected differentially or single ended. Use the E5379A vHeight spec for clock channel(s) connected differentially.

[5] Sample positions are independently adjustable for each data channel input. A negative sample position causes the input to be synchronously sampled by that amount before each active clock edge. A positive sample position causes the input to be synchronously sampled by that amount after each active clock edge. A sampling position of zero causes synchronous sampling coincident with each active clock edge.

[6] Threshold applies to single-ended input signals. Thresholds are independently adjustable for the clock input of each pod and for each set of 16 data inputs for each pod. Threshold limits apply to both the internal reference and to the external reference input on the E5378A.

# Agilent 16760A Specifications and Characteristics

## Agilent Technologies 16760A Supplemental Specifications\* and Characteristics (continued)

### Synchronous Data Sampling

#### User Adjustable Settings for Each Input

Parameter	Adjustment Range	Adjustment Range				
		1500 Mb/s mode	1250 Mb/s mode	800 Mb/s mode	400 Mb/s mode	200 Mb/s mode
Data to Clock	Adjustment Resolution tSample [5]	10 ps 0 to +4 ns	10 ps -2.5 to +2.5 ns	10 ps -2.5 to +2.5 ns	100 ps -3.2 to +3.2 ns	100 ps -3.5 to +3 ns
All Inputs	vThreshold [6]	10 mV resolution -3 to +5 V	10 mV resolution -3 to +5 V	10 mV resolution -3 to +5 V	10 mV resolution -3 to +5 V	10 mV resolution -3 to +5 V

\* All specifications noted by an asterisk in the table are the performance standards against which the product is tested.

- [1] The analyzer can be configured to sample on the rising edge, the falling edge, or both edges of the clock. If both edges are used with a single ended clock input, take care to set the clock threshold accurately to avoid phase error.
- [2] Eye width and height are specified at the probe tip. Eye width as measured by eye finder in the analyzer may be less, and still sample reliably.
- [3] For each side of a differential signal.
- [4] The clock inputs in the E5378A, E5398A, E5406A, E5390A, and E5382A may be connected differentially or single ended. Use the E5379A vHeight spec for clock channel(s) connected differentially.
- [5] Sample positions are independently adjustable for each data channel input. A negative sample position causes the input to be synchronously sampled by that amount before each active clock edge. A positive sample position causes the input to be synchronously sampled by that amount after each active clock edge. A sampling position of zero causes synchronous sampling coincident with each active clock edge.
- [6] Threshold applies to single-ended input signals. Thresholds are independently adjustable for the clock input of each pod and for each set of 16 data inputs for each pod. Threshold limits apply to both the internal reference and to the external reference input on the E5378A.

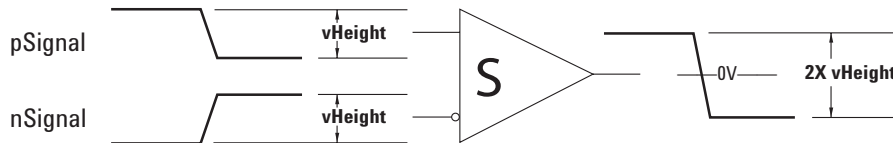

# Agilent 16760A Specifications and Characteristics

## Agilent Technologies 16760A Supplemental Specifications\* and Characteristics (continued)

<b>Synchronous State Analysis</b>	<b>1.5 Gb/s mode</b>	<b>1.25 Gb/s mode</b>	<b>800 Mb/s mode</b>	<b>400 Mb/s mode</b>	<b>200 Mb/s mode</b>
Maximum data rate on each channel [3]	1.5 Gb/s	1.25 Gb/s	800 Mb/s	400 Mb/s	200 Mb/s
Minimum clock interval, active edge to active edge* [3]	667 ps	800 ps	1.25 ns	2.5 ns	5 ns
Minimum state clock pulse width with clock polarity rising or falling [3]	N/A	N/A	600 ps	1.5 ns	1.5 ns
Clock periodicity	Clock must be periodic	Clock must be periodic	Periodic or aperiodic	Periodic or aperiodic	Periodic or aperiodic
Number of clocks	1	1	1	1	1
Clock polarity	Both edges	Both edges	Rising, falling, or both	Rising, falling, or both	Rising, falling, or both
Minimum data pulse width*	600 ps	750 ps	E5378A, E5379A, E5382A probes: 750 ps E5380A probe: 1.5 ns	1.5 ns	1.5 ns
Number of channels [1]					
• With time tags	16 x (number of modules) – 8	16 x (number of modules) – 8	34 x (number of modules) – 16	34 x (number of modules) – 16	34 x (number of modules)
• Without time tags	16 x (number of modules)	16 x (number of modules)	34 x (number of modules) – 1	34 x (number of modules)	34 x (number of modules)
Maximum channels on a single time base and trigger	80 (5 modules)	80 (5 modules)	170 (5 modules)	153 (5 modules)	170 (5 modules)
Maximum memory depth	128M samples	128M samples	64M samples	32M samples	32M samples
Time tag resolution	4 ns [2]	4 ns [2]	4 ns [2]	4 ns [2]	4 ns
Maximum time count between states	17 seconds	17 seconds	17 seconds	17 seconds	17 seconds

\* All specifications noted by an asterisk are the performance standards against which the product is tested.

[1] In 1.25 Gb/s and 1.5 Gb/s modes, only the even-numbered channels (0, 2, 4, etc.) are acquired.

[2] The resolution of the hardware used to assign time tags is 4 ns. Times of intermediate states are calculated.

[3] The choice of probe can limit system performance. Select a probe rated at the speed of the selected mode (or greater) to maintain system bandwidth.

# Agilent 16760A Specifications and Characteristics

## Agilent Technologies 16760A Supplemental Specifications\* and Characteristics (continued)

<b>Synchronous State Analysis</b> (continued)	<b>1.5 Gb/s mode</b>	<b>1.25 Gb/s mode</b>	<b>800 Mb/s mode</b>	<b>400 Mb/s mode</b>	<b>200 Mb/s mode</b>
Trigger resources	3 Patterns on each pod evaluated as =, ≠, >, <, ≥, ≤ on one pod; or evaluated as =, ≠ across multiple pods; or 1 range on each pod 4 Flags Arm in	3 Patterns on each pod evaluated as =, ≠, >, <, ≥, ≤ on one pod; or evaluated as =, ≠ across multiple pods; or 1 range on each pod 4 Flags Arm in	4 Patterns on each pod evaluated as =, ≠, >, <, ≥, ≤ on one pod; or evaluated as =, ≠ across multiple pods; or 2 ranges on each pod 4 Flags Arm in	8 Patterns evaluated as =, ≠, >, <, ≥, ≤ 4 Ranges evaluated as in range, not in range 2 Occurrence counters 4 Flags Arm in	16 Patterns evaluated as =, ≠, >, <, ≥, ≤ 15 Ranges evaluated as in range, not in range Timers: 2 x (number of modules) – 1 2 Global counters 1 Occurrence counter per sequence level 4 Flags Arm in
Trigger actions	Trigger and fill memory	Trigger and fill memory	Trigger and fill memory	Goto Trigger and fill memory	Goto Trigger and fill memory Trigger and goto Store/don't store sample Turn default storing on/off Timer start/stop/pause/resume Global counter increment/reset Occurrence counter reset Flag set/clear

\* All specifications noted by an asterisk are the performance standards against which the product is tested.

[1] In 1.25 Gb/s and 1.5 Gb/s modes, only the even-numbered channels (0, 2, 4, etc.) are acquired.

[2] The resolution of the hardware used to assign time tags is 4 ns. Times of intermediate states are calculated.

[3] The choice of probe can limit system performance. Select a probe rated at the speed of the selected mode (or greater) to maintain system bandwidth.

# Agilent 16760A Specifications and Characteristics

## Agilent Technologies 16760A Supplemental Specifications\* and Characteristics (continued)

### Synchronous State

Analysis [4] (continued)	1.5 Gb/s mode	1.25 Gb/s mode	800 Mb/s mode	400 Mb/s mode	200 Mb/s mode
Maximum trigger sequence levels	2	2	4	16	16
Maximum trigger sequencer speed	1.5 Gb/s	1.25 Gb/s	800 MHz	400 MHz	200 MHz
Store qualification	Default	Default	Default	Default	Default and per sequence level
Maximum global counter	N/A	N/A	N/A	N/A	16,777,215
Maximum occurrence counter	N/A	N/A	N/A	N/A	16,777,215
Maximum pattern/range term width	32 bits [3]	32 bits [3]	32 bits [3]	32 bits [3]	32 bits [3]
Timer value range	N/A	N/A	N/A	N/A	100 ns to 4397 seconds
Timer resolution	N/A	N/A	N/A	N/A	4 ns
Timer accuracy	N/A	N/A	N/A	N/A	$\pm(10 \text{ ns} + 0.01\% \text{ of value})$
Timer reset latency	N/A	N/A	N/A	N/A	65 ns
Data in to BNC port out latency	150 ns	150 ns	150 ns	150 ns	150 ns
Flag set/reset to evaluation latency	N/A	N/A	N/A	N/A	110 ns

[1] In 1.25 Gb/s and 1.5 Gb/s modes, only the even-numbered channels (0, 2, 4, etc.) are acquired.

[2] The resolution of the hardware used to assign time tags is 4 ns. Times of intermediate states are calculated.

[3] Maximum label width is 32 bits. Wider patterns can be created by "Anding" multiple labels together.

[4] The choice of probe can limit system performance. Select a probe rated at the speed of the selected mode (or greater) to maintain system bandwidth.

### Asynchronous Timing Analysis

### Conventional Timing Analysis

### Transitional Timing Analysis

Maximum timing analysis sample rate	800 MHz	400 MHz
Number of channels	34 x (number of modules)	Sampling rates < 400 MHz: 34 x (number of modules) Sampling rates = 400 MHz: 34 x (number of modules) – 17 [1]
Maximum channels on a single time base and trigger	170 (5 modules)	170 (5 modules)
Sample period	1.25 ns	2.5 ns to 1 ms [1]
Memory Depth	64 M Samples	32 M Samples [1]

[1] With all pods assigned in transitional/store qualified timing, minimum sample period is 5 ns and maximum memory depth is 16 M samples.

# Agilent 16760A Specifications and Characteristics

## Agilent Technologies 16760A Supplemental Specifications\* and Characteristics (continued)

Asynchronous Timing Analysis (continued)	Conventional Timing Analysis	Transitional Timing Analysis
Sample period accuracy	$\pm(250 \text{ ps} + 0.01\% \text{ of sample period})$	$\pm(250 \text{ ps} + 0.01\% \text{ of sample period})$
Channel-to-channel skew	< 1.5 ns	< 1.5 ns
Time interval accuracy	$\pm[\text{sample period} + (\text{channel-to-channel skew}) + (0.01\% \text{ of time interval})]$	$\pm[\text{sample period} + (\text{channel-to-channel skew}) + (0.01\% \text{ of time interval})]$
Minimum data pulse width	1.5 ns for data capture 5.1 ns for trigger sequencing	3.8 ns for data capture 5.1 ns for trigger sequencing
Maximum trigger sequencer speed	200 MHz	200 MHz
Trigger resources	16 Patterns evaluated as =, ≠, >, <, ≥, ≤ 15 Ranges evaluated as in range, not in range 2 Edge/glitch (2 Timers per module) – 1 2 Global counters 1 Occurrence counter per sequence level 4 Flags, Arm In	16 Patterns evaluated as =, ≠, >, <, ≥, ≤ 15 Ranges evaluated as in range, not in range 2 Edge/glitch (2 Timers per module) – 1 2 Global counters 1 Occurrence counter per sequence level 4 Flags, Arm In
Trigger resource conditions	Arbitrary Boolean combinations	Arbitrary Boolean combinations
Trigger actions	Goto Trigger and fill memory Trigger and goto Timer start/stop/pause/resume Global counter increment/reset Occurrence counter reset	Goto Trigger and fill memory Trigger and goto Timer/start/stop/pause/resume Global counter increment/reset Occurrence counter reset
Maximum global counter	16,777,215	16,777,215
Maximum occurrence counter	16,777,215	16,777,215
Timer value range	100 ns to 4397 seconds	100 ns to 4397 seconds
Timer resolution	4 ns	4 ns
Timer accuracy	$\pm(10 \text{ ns} + 0.01\%)$	$\pm(10 \text{ ns} + 0.01\%)$
Greater than duration	5 ns to 83 ms in 5 ns increments	5 ns to 83 ms in 5 ns increments
Less than duration	10 ns to 83 ms in 5 ns increments	10 ns to 83 ms in 5 ns increments
Timer reset latency	60 ns	60 ns
Data in to BNC port out delay latency	150 ns	150 ns
Flag set/reset to evaluation latency	110 ns	110 ns
<b>Environmental</b>		
Operating temperature	0 deg C to 45 deg C	

# Agilent 16720A Pattern Generator Specifications and Characteristics

## 16720A Pattern Generator Characteristics

Maximum memory depth	16 MVectors
Number of output channels at > 180 MHz and ≤ 300 MHz clock	24
Number of output channels at ≤ 180 MHz clock	48
Number of different macros	limited only by the pattern generator's available memory depth
Maximum number of lines in a macro	
Maximum number of parameters in a macro	
Maximum number of macro invocations	
Maximum loop count in a repeat loop	
Maximum number of repeat loop invocations	1000
Maximum number of "Wait" event patterns	4
Number of input lines to define a pattern	3
Maximum number of modules in a system	5
Maximum width of a vector (in a 5 module system)	240 bits
Maximum width of a label	128 bits
Maximum number of labels	limited only by system memory
Maximum number of vectors in all formats	16 MVectors
Minimum number of vectors in binary format when loading into hardware	4096

## Lead Set Characteristics

Agilent 10474A 8-channel probe lead set*	Provides most cost effective lead set for the 16720A clock and data pods. Grabbers are not included. Lead wire length is 12 inches.
Agilent 10347A 8-channel probe lead set	Provides 50 Ω coaxial lead set for unterminated signals, required for 10465A ECL Data Pod (unterminated). Grabbers are not included.
Agilent 10498A 8-channel probe lead set*	Provides most cost effective lead set for the 16720A clock and data pods. Grabbers are not included. Lead wire length is 6 inches.
Agilent E8142A 8-channel probe lead set	Provides lead set for the 16720A LVDS clock and data pods. Grabbers are not included. Lead wire length is 6 inches.

\* For all clock and data pods except 10465A unterminated ECL Data Pod and E8140A/E8141A clock and data pods.

# Agilent 16720A Pattern Generator Specifications and Characteristics

## Data Pod Characteristics

Note: Data Pod output parametrics depend on the output driver and the impedance load of the target system. Check the device data book for the specific drivers listed for each pod.

### Agilent 10461A TTL Data Pod

Output type	10H125 with 100 $\Omega$ series
Maximum clock	200 MHz
Skew [1]	typical < 2 ns; worst case = 4 ns
Recommended lead set	Agilent 10474A

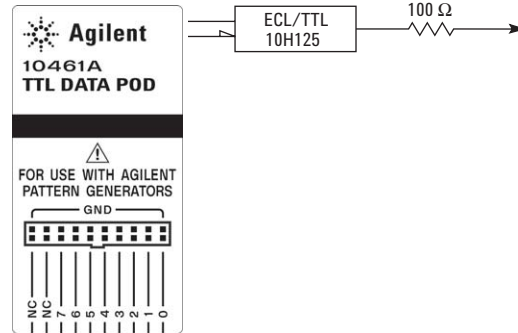

### Agilent 10462A 3-State TTL/CMOS Data Pod

Output type	74ACT11244 with 100 $\Omega$ series; 10H125 on non 3-state channel 7 [2]
3-state enable	negative true, 100 K $\Omega$ to GND, enabled on no connect
Maximum clock	100 MHz
Skew [1]	typical < 4 ns; worst case = 12 ns
Recommended lead set	Agilent 10474A

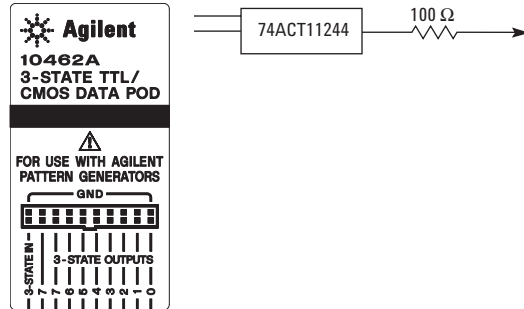

### Agilent 10464A ECL Data Pod (terminated)

Output type	10H115 with 330 $\Omega$ pulldown, 47 $\Omega$ series
Maximum clock	300 MHz
Skew [1]	typical < 1 ns; worst case = 2 ns
Recommended lead set	Agilent 10474A

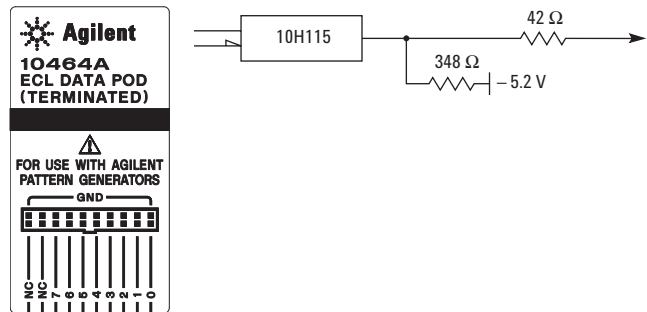

[1] Typical skew measurements made at pod connector with approximately 10 pF/50 K $\Omega$  load to GND; worst case skew numbers are a calculation of worst case conditions through circuits. Both numbers apply to any channel within a single or multiple module system.

[2] Channel 7 on the 3-state pods has been brought out in parallel as a non 3-state signal. By looping this output back into the 3-state enable line, the channel can be used as a 3-state enable.



# Agilent 16720A Pattern Generator Specifications and Characteristics

## Agilent 10465A ECL Data Pod (unterminated)

Output type	10H115 (no termination)
Maximum clock	300 MHz
Skew [1]	typical < 1 ns; worst case = 2 ns
Recommended lead set	Agilent 10347A

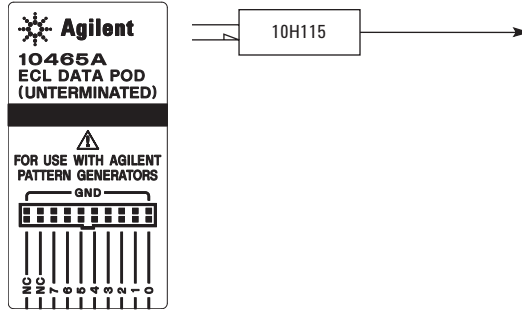

## Agilent 10466A 3-State TTL/3.3 volt Data Pod

Output type	74LVT244 with 100 $\Omega$ series; 10H125 on non 3-state channel 7 [2]
3-state enable	negative true, 100 K $\Omega$ to GND, enabled on no connect
Maximum clock	200 MHz
Skew [1]	typical < 3 ns; worst case = 7 ns
Recommended lead set	Agilent 10474A

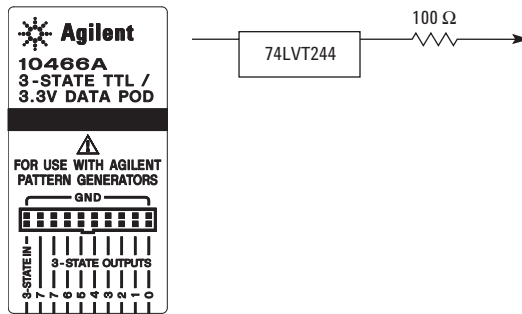

- [1] Typical skew measurements made at pod connector with approximately 10 pF/50 K $\Omega$  load to GND; worst case skew numbers are a calculation of worst case conditions through circuits. Both numbers apply to any channel within a single or multiple module system.
- [2] Channel 7 on the 3-state pods has been brought out in parallel as a non 3-state signal. By looping this output back into the 3-state enable line, the channel can be used as a 3-state enable.

# Agilent 16720A Pattern Generator Specifications and Characteristics

## Agilent 10469A 5 volt PECL Data Pod

Output type	100EL90 (5V) with 348 ohm pulldown to ground and 42 ohm in series
Maximum clock	300 MHz
Skew [1]	typical < 500 ps; worst case = 1 ns
Recommended lead set	Agilent 10498A

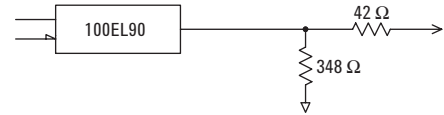
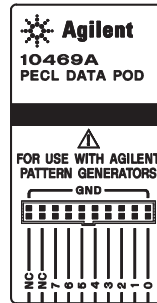

## Agilent 10471A 3.3 volt LVPECL Data Pod

Output type	100LVEL90 (3.3V) with 215 ohm pulldown to ground and 42 ohm in series
Maximum clock	300 MHz
Skew [1]	typical < 500 ps; worst case = 1 ns
Recommended lead set	Agilent 10498A

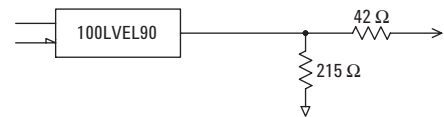
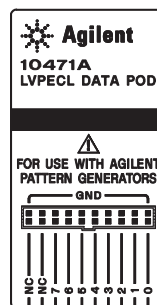

## Agilent 10473A 3-State 2.5 Volt Data Pod

Output type	74AVC16244
3-state enable	negative true, 38 KΩ to GND, enabled on no connect
Maximum clock	300 MHz
Skew [1]	typical < 1.5 ns; worst case = 2 ns
Recommended lead set	Agilent 10498A

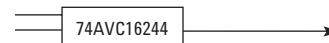
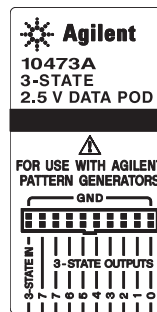

[1] Typical skew measurements made at pod connector with approximately 10 pF/50 KΩ load to GND; worst case skew numbers are a calculation of worst case conditions through circuits. Both numbers apply to any channel within a single or multiple module system.

[2] Channel 7 on the 3-state pods has been brought out in parallel as a non 3-state signal. By looping this output back into the 3-state enable line, the channel can be used as a 3-state enable.

# Agilent 16720A Pattern Generator Specifications and Characteristics

## Agilent 10476A 3-State 1.8 Volt Data Pod

Output type	74AVC16244
3-state enable	negative true, 38 K $\Omega$ to GND, enabled on no connect
Maximum clock	300 MHz
Skew [1]	typical < 1.5 ns; worst case = 2 ns
Recommended lead set	Agilent 10498A

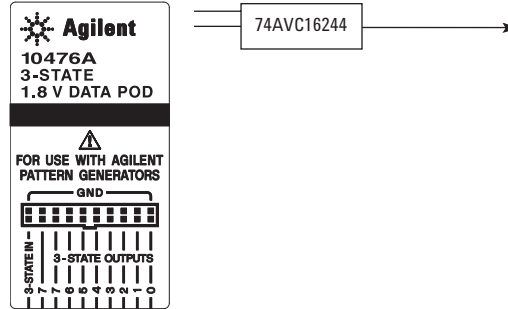

## Agilent 10483A 3-State 3.3 Volt Data Pod

Output type	74AVC16244
3-state enable	negative true, 38 K $\Omega$ to GND, enabled on no connect
Maximum clock	300 MHz
Skew [1]	typical < 1.5 ns; worst case = 2 ns
Recommended lead set	Agilent 10498A

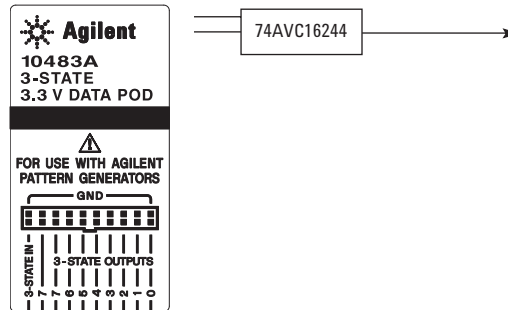

## Agilent E8141A LVDS Data Pod

Output type	65LVDS389 (LVDS data lines) 10H125 (TTL non-3-state channel 7)
3-state enable	positive true TTL; no connect=enabled
Maximum clock	300 MHz
Skew	typical < 1 ns; worst case = 2 ns
Recommended lead set:	E8142A
Recommended lead set	Agilent 10498A

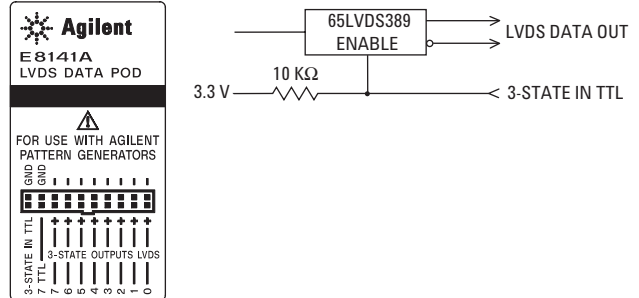

[1] Typical skew measurements made at pod connector with approximately 10 pF/50 K $\Omega$  load to GND; worst case skew numbers are a calculation of worst case conditions through circuits. Both numbers apply to any channel within a single or multiple module system.

# Agilent 16720A Pattern Generator Specifications and Characteristics

## Data Cable Characteristics Without a Data Pod

The Agilent 16720A data cables without a data pod provide an ECL terminated (1 k $\Omega$  to -5.2V) differential signal (from a type 10E156 or 10E154 driver). These are usable when received by a differential receiver, preferably with a 100  $\Omega$  termination across the lines. These signals should not be used single ended due to the slow fall time and shifted voltage threshold (they are not ECL compatible).

### 16720A

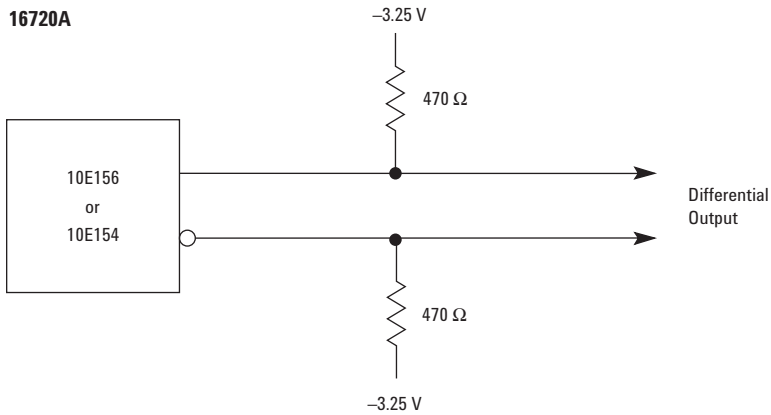

### 16522A

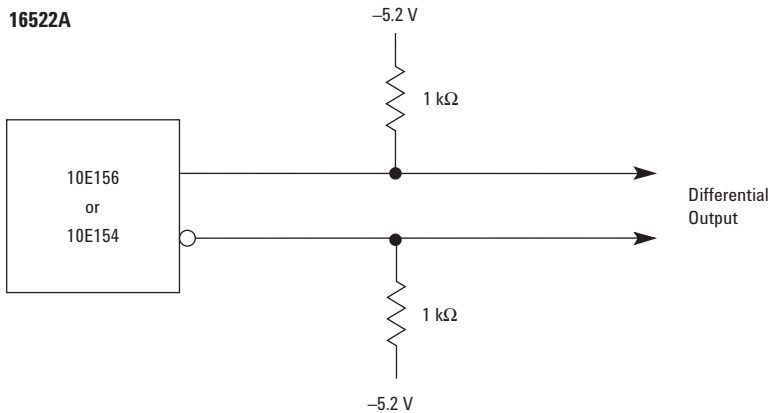

### 16720A Cable Pin Outs

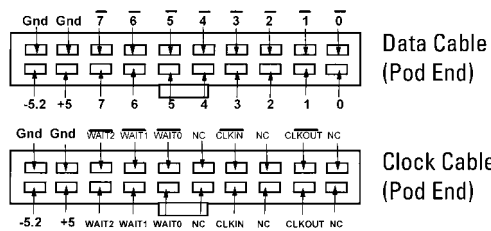

# Agilent 16720A Pattern Generator Specifications and Characteristics

## Clock Cable Characteristics Without a Clock Pod

The Agilent 16720A clock cables without a clock pod provide an ECL terminated (1 K $\Omega$  to -5.2V) differential signal (from a type 10E164 driver). These are usable when received by a differential receiver, preferably with a 100  $\Omega$  termination across the lines. These signals should not be used single ended due to the slow fall time and shifted voltage threshold (they are not ECL compatible).

---

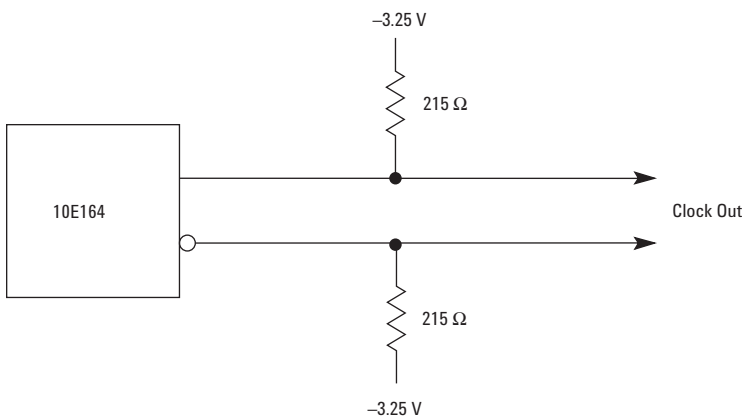
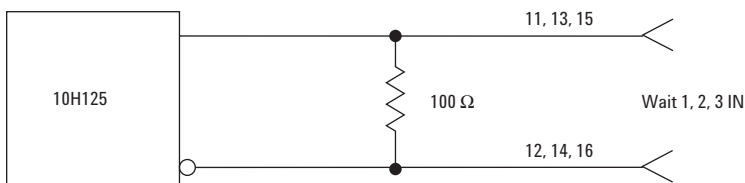
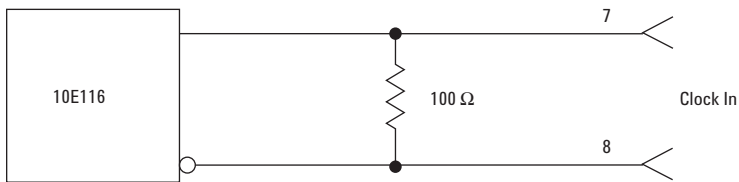

# Agilent 16720A Pattern Generator Specifications and Characteristics

## Clock Pod Characteristics

### 10460A TTL Clock Pod

Clock output type	10H125 with 47 $\Omega$ series; true & inverted
Clock output rate	100 MHz maximum
Clock out delay	approximately 8 ns total in 14 steps (16720A only); 11 ns maximum in 9 steps (16522A only)
Clock input type	TTL – 10H124
Clock input rate	dc to 100 MHz
Pattern input type	TTL – 10H124 (no connect is logic 1)
Clock-in to clock-out	approximately 30 ns
Pattern-in to recognition	approximately 15 ns + 1 clk period
Recommended lead set	Agilent 10474A

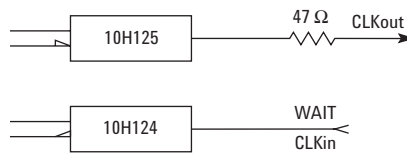
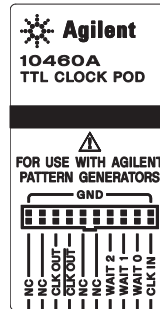

### 10463A ECL Clock Pod

Clock output type	10H116 differential unterminated; and differential with 330 $\Omega$ to $-5.2V$ and 47 $\Omega$ series
Clock output rate	300 MHz maximum
Clock out delay	approximately 8 ns total in 14 steps (16720A only); 11 ns maximum in 9 steps (16522A only)
Clock input type	ECL – 10H116 with 50 K $\Omega$ to $-5.2v$
Clock input rate	dc to 300 MHz
Pattern input type	ECL – 10H116 with 50 K $\Omega$ (no connect is logic 0)
Clock-in to clock-out	approximately 30 ns
Pattern-in to recognition	approximately 15 ns + 1 clk period
Recommended lead set	Agilent 10474A

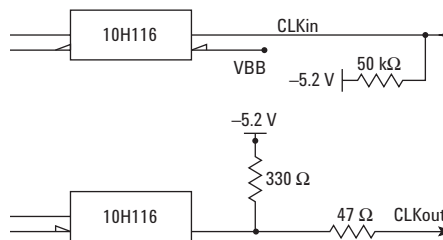
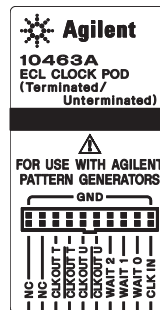

# Agilent 16720A Pattern Generator Specifications and Characteristics

## 10468A 5 volt PECL Clock Pod

Clock output type	100EL90 (5V) with 348 ohm pulldown to ground and 42 ohm in series
Clock output rate	300 MHz maximum
Clock out delay	approximately 8 ns total in 14 steps (16720A only); 11 ns maximum in 9 steps (16522A only)
Clock input type	100EL91 PECL (5V), no termination
Clock input rate	dc to 300 MHz
Pattern input type	100EL91 PECL (5V), no termination (no connect is logic 0)
Clock-in to clock-out	approximately 30 ns
Pattern-in to recognition	approximately 15 ns + 1 clk period
Recommended lead set	Agilent 10498A

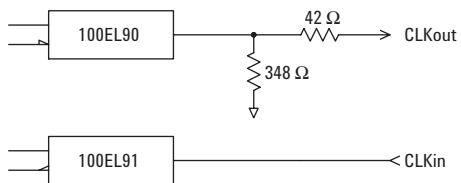
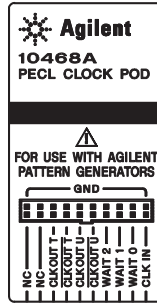

## 10470A 3.3 volt LVPECL Clock Pod

Clock output type	100LVEL90 (3.3V) with 215 ohm pulldown to ground and 42 ohm in series
Clock output rate	300 MHz maximum
Clock out delay	approximately 8 ns total in 14 steps (16720A only); 11 ns maximum in 9 steps (16522A only)
Clock input type	100LVEL91 LVPECL (3.3V), no termination
Clock input rate	dc to 300 MHz
Pattern input type	100LVEL91 LVPECL (3.3V), no termination (no connect is logic 0)
Clock-in to clock-out	approximately 30 ns
Pattern-in to recognition	approximately 15 ns + 1 clk period
Recommended lead set	Agilent 10498A

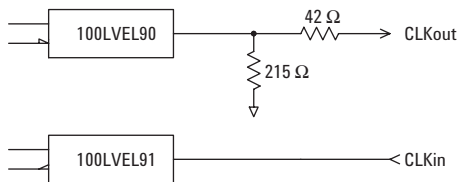
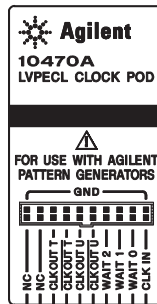

# Agilent 16720A Pattern Generator Specifications and Characteristics

## 10472A 2.5 volt Clock Pod

Clock output type	74AVC16244
Clock output rate	200 MHz maximum
Clock out delay	approximately 8 ns total in 14 steps (16720A only); 11 ns maximum in 9 steps (16522A only)
Clock input type	74AVC16244 (3.6V max)
Clock input rate	dc to 200 MHz
Pattern input type	74AVC16244 (3.6V max; no connect is logic 0)
Clock-in to clock-out	approximately 30 ns
Pattern-in to recognition	approximately 15 ns + 1 clk period
Recommended lead set	Agilent 10498A

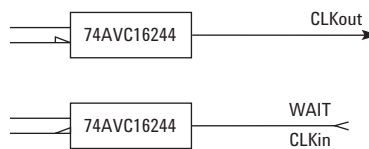
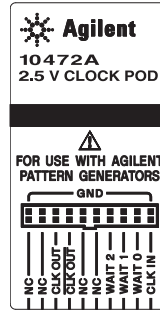

## 10475A 1.8 volt Clock Pod

Clock output type	74AVC16244
Clock output rate	200 MHz maximum
Clock out delay	approximately 8 ns total in 14 steps (16720A only); 11 ns maximum in 9 steps (16522A only)
Clock input type	74AVC16244 (3.6V max)
Clock input rate	dc to 200 MHz
Pattern input type	74AVC16244 (3.6V max; no connect is logic 0)
Clock-in to clock-out	approximately 30 ns
Pattern-in to recognition	approximately 15 ns + 1 clk period
Recommended lead set	Agilent 10498A

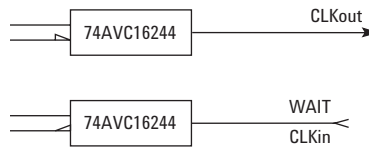
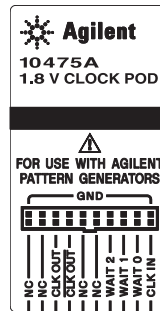



# Agilent 16720A Pattern Generator Specifications and Characteristics

## 10477A 3.3 volt Clock Pod

Clock output type	74AVC16244
Clock output rate	200 MHz maximum
Clock out delay	approximately 8 ns total in 14 steps (16720A only); 11 ns maximum in 9 steps (16522A only)
Clock input type	74AVC16244 (3.6V max)
Clock input rate	dc to 200 MHz
Pattern input type	74AVC16244 (3.6V max; no connect is logic 0)
Clock-in to clock-out	approximately 30 ns
Pattern-in to recognition	approximately 15 ns + 1 clk period
Recommended lead set	Agilent 10498A

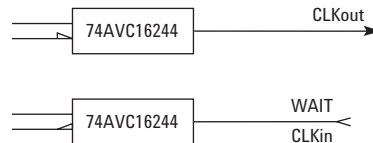
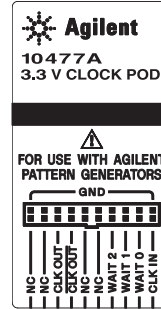

## E8140A LVDS Clock Pod

Clock output type	65LVDS179 (LVDS) and 10H125 (TTL)
Clock output rate	200 MHz maximum (LVDS and TTL)
Clock out delay	approximately 8 ns total in 14 steps
Clock input type	65LVDS179 (LVDS with 100 ohm)
Clock input rate	dc to 150 MHz (LVDS)
Pattern input type	10H124 (TTL) (no connect = logic 1)
Clock-in to clock-out	approximately 30 ns
Pattern-in to recognition	approximately 15 ns + 1 clk period
Recommended lead set	Agilent 10498A

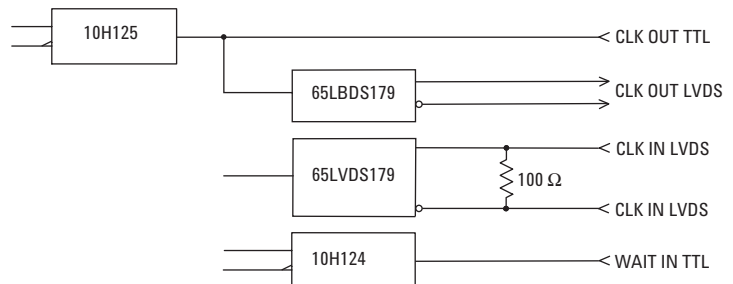
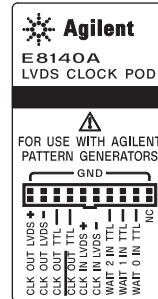

# Agilent Module Specifications and Characteristics

## Power Requirements

All necessary power is supplied by the backplane connector of the logic analysis system mainframe.

## Environmental Characteristics

Indoor use only

## Operating Environment

Temperature	0 to 40 °C (+32 to +104 °F) when operating in a 16900A or 16902A/B mainframe. 0 to 45 °C (+32 to +113 °F) when operating in a 16901A mainframe. 0 to 50 °C (+32 to +122 °F) when operating in a 16903A mainframe.
-------------	---

Humidity	0 to 80% relative humidity at 40 °C (+104 °F). Reliability is enhanced when operating within the range 20% to 80% non-condensing.
----------	---

Altitude	0 to 3000 m (10,000 ft)
----------	-------------------------

Vibration	Random vibration 5 to 500 Hz, 10 minutes per axis, approximately 0.2 g rms
-----------	--

## Non-Operating Environment

Temperature	–40 to +75 °C (–40 to +167 °F). Protect the instrument from temperature extremes which cause condensation on the instrument.
-------------	--

Humidity	0 to 90% at 65 °C (149 °F)
----------	----------------------------

Altitude	0 to 15,300 m (50,000 ft)
----------	---------------------------

Vibration (in shipping carton)	Random vibration 5 to 500 Hz, 10 minutes per axis, approximately 2.41 g rms; and swept sine resonant search, 5 to 500 Hz, 0.50 g (0-peak), 5-minute resonant dwell at 4 resonances per axis.
--------------------------------	--

See individual probe Specifications and Characteristics for probe environmental characteristics.

The 16900 Series logic analysis system also supports the following logic analysis modules.

### State/Timing Modules

16740A, 16741A, 16742A

16750A/B, 16751A/B, 16752A/B

16753A, 16754A, 16755A, 16756A

## Related literature

Publication title	Publication type	Publication number
<i>Agilent 16900 Series Logic Analysis System Mainframes</i>	Data Sheet	5989-0421EN
<i>Agilent Technologies 16800 Series Portable Logic Analyzers</i>	Brochure	5989-5062EN
<i>Agilent Technologies 16800 Series Portable Logic Analyzers</i>	Data Sheet	5989-5063EN
<i>Agilent Technologies FPGA Dynamic Probe for Xilinx</i>	Data Sheet	5989-0423EN
<i>Agilent Technologies FPGA Dynamic Probe for Altera</i>	Data Sheet	5989-5595EN
<i>Probing Solutions for Agilent Technologies Logic Analyzers</i>	Catalog	5968-4632E
<i>Application Support for Agilent Logic Analyzers</i>	Configuration Guide	5966-4365E
<i>Innovative Digital Debug Solutions CD with Videos</i>	CD-ROM	5980-0941EN



### Agilent Email Updates

[www.agilent.com/find/emailupdates](http://www.agilent.com/find/emailupdates)

Get the latest information on the products and applications you select.



### Agilent Direct

[www.agilent.com/find/quick](http://www.agilent.com/find/quick)

Quickly choose and use your test equipment solutions with confidence.



[www.agilent.com/find/open](http://www.agilent.com/find/open)

Agilent Open simplifies the process of connecting and programming test systems to help engineers design, validate and manufacture electronic products. Agilent offers open connectivity for a broad range of system-ready instruments, open industry software, PC-standard I/O and global support, which are combined to more easily integrate test system development.

## Remove all doubt

Our repair and calibration services will get your equipment back to you, performing like new, when promised. You will get full value out of your Agilent equipment throughout its lifetime. Your equipment will be serviced by Agilent-trained technicians using the latest factory calibration procedures, automated repair diagnostics and genuine parts. You will always have the utmost confidence in your measurements.

Agilent offers a wide range of additional expert test and measurement services for your equipment, including initial start-up assistance onsite education and training, as well as design, system integration, and project management.

For more information on repair and calibration services, go to

[www.agilent.com/find/removealldoubt](http://www.agilent.com/find/removealldoubt)

## [www.agilent.com](http://www.agilent.com)

For more information on Agilent Technologies' products, applications or services, please contact your local Agilent office. The complete list is available at:

[www.agilent.com/find/contactus](http://www.agilent.com/find/contactus)

### Phone or Fax

#### United States:

(tel) 800 829 4444  
(fax) 800 829 4433

#### Canada:

(tel) 877 894 4414  
(fax) 800 746 4866

#### China:

(tel) 800 810 0189  
(fax) 800 820 2816

#### Europe:

(tel) 31 20 547 2111

#### Japan:

(tel) (81) 426 56 7832  
(fax) (81) 426 56 7840

#### Korea:

(tel) (080) 769 0800  
(fax) (080) 769 0900

#### Latin America:

(tel) (305) 269 7500

#### Taiwan:

(tel) 0800 047 866  
(fax) 0800 286 331

#### Other Asia Pacific Countries:

(tel) (65) 6375 8100  
(fax) (65) 6755 0042  
Email: [tm\\_ap@agilent.com](mailto:tm_ap@agilent.com)

Revised: 09/14/06

Product specifications and descriptions in this document subject to change without notice.

© Agilent Technologies, Inc. 2007  
Printed in USA, November 1, 2007  
5989-0422EN



Agilent Technologies